

**Healthcare Furniture**

Effective July 5, 2022 USA



PRICE LIST  
**healthncare**



# introduction

Since 1985, Global has been a primary source for furniture in hospitals and elder care facilities.

We offer a comprehensive line of products and services. Our customers appreciate and recognize our value-added consulting and problem-solving resources as this enables them to protect their investments long-term.

Global's healthcare products are specifically designed to promote enhanced levels of wellness. Our furniture solutions are migrating into commercial spaces due to the significant increase in the aging population and the need for properly designed solutions.

Our vertically integrated manufacturing supply chain allows Global to manage the process and to access and monitor the quality of materials and production standards. This vertical integration allows us to control manufacturing and delivery cycles.

We make what you need. Our solutions are suitable for high traffic, challenging public and private spaces. The product development process focuses on ensuring the product is suitable for use and can meet the many faceted challenges of today's public shared spaces.

Hospitals, medical practice centers, senior care facilities, public housing, treatment programs even veterinary clinics can have peace of mind when using healthcare furniture solutions.

Global continuously strives to achieve excellence in what we do. We are proud to have played a major role in setting some of the highest quality standards in the industry. We partner with clients to ensure we understand their needs, culture and goals.

We often modify our products when special requirements dictate the need, in order to provide the best possible solution for an application.

We are committed to producing products in the most sustainable ways ensuring they pass strict quality testing. See below for GREENGUARD and level certification information.

We value our clients and strive to build lifelong partnerships through trust, respect and successful outcomes.

## SYMBOL IDENTIFICATION



Global's certified products are in compliance with the stringent emission guidelines set by the Greenguard Environmental Institute and include all upholstered seating.

To obtain a Greenguard certificate for any product, please go to the product page on our website [www.globalfurnituregroup.com](http://www.globalfurnituregroup.com) and click on "view Greenguard certificate".



level™ certification, based on the ANSI/BIFMA e3-2012 furniture sustainability standard, sets furniture manufacturers on a path toward greater sustainability over time. Based on environmental and social criteria set forth in the standard, a product's entire supply chain is assessed.

Certification assessment includes an evaluation of specific corporate policies and guidelines and an assessment of associated company manufacturing facilities. Products must meet quantifiable milestones of environmental and social performance at every step of development.

The quantitative assessment addresses four categories: material use, energy and atmosphere impacts, human and ecosystem health and social responsibility. Manufacturers earn points in each of the four categories. The level™ brand and its numeric rating of 1, 2 or 3 indicate what threshold of certification a product has achieved. Level™ 3 is the highest rating.

## GLOBAL USA Showrooms + Distribution Centers

Marlton, New Jersey

Atlanta, Georgia

Andover, Massachusetts

Boston, Massachusetts

Buford, Georgia

Chicago, Illinois

Cincinnati, Ohio

Dallas, Texas

Denver, Colorado

Elkridge, Maryland

Houston, Texas

Lenexa, Kansas

Miami, Florida

New York, New York

Philadelphia, Pennsylvania

Phoenix, Arizona

Renton, Washington

Sunrise, Florida

Tampa, Florida

Washington, DC

Winfield, California

# TABLE OF CONTENTS

SEATING	SEATING (cont'd)	BARIATRIC SEATING
Adeline .....page 62	Primacare benches .....page 184	Aubra .....page 64
Aubra .....page 64	Primacare dining .....page 152	Calidon .....page 70
Bishop.....page 69	Primacare guest .....page 154	Frolick.....page 90
Calidon .....page 70	Primacare lounge .....page 171	GC Belong.....page 97
Coast .....page 77	Primacare lounge, fully upholstered .....page 176	GC Comet .....page 126
Desmond .....page 78	Primacare modular, guest/patient .....page 189	GC Sidero .....page 128
Desmond HT.....page 79	Primacare modular, lounge .....page 205	Nourish.....page 145
Doctor Buddy.....page 81	Primacare patient.....page 163	Primacare lounge .....page 171
Dreme.....page 82	Primacare recliners .....page 180	Primacare lounge, fully upholstered .....page 176
Erin .....page 85	Primacare sleepers.....page 182	Primacare modular, guest/patient .....page 189
Flap.....page 87	Primacare Wingback.....page 178	Primacare modular, lounge .....page 205
Foot activated stools.....page 89	River+ .....page 215	Primacare patient.....page 163
Frolick.....page 90	Senator.....page 216	Primacare Wingback .....page 178
Gala II .....page 95	Sleep-Eez.....page 217	Strand.....page 218
GC Beach.....page 96	Splash.....page 90	
GC Belong.....page 97	Strand.....page 218	
GC Comet .....page 126	Wingback.....page 225	
GC Islands .....page 127		
GC Sidero .....page 128		
GC Sirena .....page 138		
GC Vion.....page 140		
GC Wind.....page 142		
Janna.....page 144		
Nourish.....page 145		

**TABLES**

Aubra Tables .....page 36

Calidon Tables.....page 74

Enable Tables .....page 38

Floral Dining Tables.....page 34

GC-Belong Tables .....page 41

Occasional Tables .....page 44

Overbed Tables.....page 50

Primacare Tables.....page 56

Primacare Modular Tables .....page 199

Tablet Tables .....page 58

**PATIENT + RESIDENT ROOM FURNITURE**

Aldon .....page 6

Sonoma .....page 20

**ACCESSORIES**

Ottomans.....page 148

Throw pillows.....page 226

**REFERENCE**

Healthcare definitions.....page 4

Seating application guidelines .....page 61

COM Authorization Form.....page 232

Think Global-Think Green.....page 233

Textiles + Finishes .....page 228

Terms and Conditions.....page 234

Warranty .....page 236

# GLOBAL HEALTHCARE DEFINITIONS

Global Healthcare often requires solutions to address unique and diverse requirements within the vast range of healthcare applications. The following definitions describe the Global healthcare product solutions available.

## **ADDITIONAL WEIGHT**

For unique and demanding challenges in behavioral health facilities, products are weighted to reduce the ease of movement or lifting product to use as a weapon. The product selection and application identified will assist in determining the amount of additional weight required. Weighted product is designed for facilities looking to create safe and secure environments, while ensuring the furniture can withstand intensive use. To determine the amount of additional weight to be added to a product, contact your Global representative.

## **BED BUG RESISTANT**

Due to an increase in the presence of bed bugs within healthcare facilities, solutions have been developed to deal with the bed bug issue. The product design directly affects the level of resistance that can be achieved. For more detailed information, contact your Global representative.

## **CONTRABAND RESISTANT**

Making a product contraband resistant is a potential solution if you want upholstered and comfortable products to be finished in a manner that offers a greater level of safety. Contraband resistant finishing is added to products in high risk areas where individuals might attempt to hide contraband such as weapons (for self-harm or to cause harm to others), drugs or alcohol. It can also be part of a solution for protecting any area of the product from becoming a ligature point. The product surfaces and upholstery will be evaluated and the appropriate solutions will be applied to ensure all surfaces are sealed and safely protected. Depending on the product design, this could mean any combination of the following applications: sealed seams, sealed underside, tamperproof fasteners and/or sealed zippers. After being evaluated, solutions are applied based on the application and population being served. The result of this process would enable the caregiver to identify a potential threat as it would be apparent that the product surface was tampered with. To further assist product selection and what is required specific to a product, please contact your Global representative.

## **HIGH DENSITY ULTRACELL FOAM**

High density Ultracell foam is a non-allergenic foam manufactured from natural seed-based oils such as soybean. It significantly decreases the dependence on fossil fuels like petroleum and reduces greenhouse gas emissions. The high density of the foam provides comfortable sitting for many years before any sagging or indents appear underneath upholstery. Simply, there is more material available to allow for enhanced performance.

## **MENTAL HEALTH FURNITURE**

Mental health furniture can range from simple to complex, depending on the application and population. Global understands the unique nature and the need to offer a vast range of solutions to deal with the safety of staff and patients while respecting budgets and individual needs. This allows the client to select a product from our complete offering and then build it up to ensure the right features are included. Here are some of the optional features available: tamperproof fasteners, additional weight, floor mount brackets, puncture resistant textile and other contraband resistant features that are needed for the application. Whatever the demand, the correct solution can be built-in. For more detailed information, contact your Global representative.

## **MOISTURE BARRIER**

Moisture barrier is a textile lining with moisture repellent qualities. Moisture barrier lining is applied on the seat cushion between the upholstery cover and foam to prevent any form of moisture from getting to the foam. It is recommended when the fabric being used does not have moisture repellent qualities or when additional protection from penetration of moisture is desired. For coated textiles, the additional moisture barrier option may not be selected in conjunction with sealed seams.

## **MOISTURE AND TAMPER RESISTANT ZIPPER**

Moisture and tamper resistant zippers are available as part of the solution when requesting bed bug resistant furniture and contraband resistant solutions. In addition, this special zipper prevents liquid and moisture seepage through the zipper teeth, providing additional peace of mind. For more detailed information based on the product selection, contact your Global representative.

## **SEALED UNDERSIDE**

Sealed underside refers to the process of finishing the underside of a product to ensure no potential openings from the textile surface to the product interior on seat and/or back seams. The sealed underside solution is requested for achieving higher levels of infection prevention control for the product being ordered. The sealed underside option is noted in the price list notes with the upcharge for the respective product. For more detailed information and to determine if the sealed underside process is available on a particular product selection where it is not noted, contact your Global representative.

## **SEALED SEAMS**

The heat-sealed seams process involves sealing the back of a seam with a specially designed tape. Sealing the seam increases the integrity of the seam reducing the likelihood of seams opening over time. This tape provides additional protection against moisture seepage and prevents insects from entering the product through the stitch holes and seams. The sealed seam process is available for use on most coated textiles and is not available on woven textiles. Some coated textiles do not allow sealed seams to be used. In the event sealed seams are to be used, contact Customer Care to confirm sealed seams are approved for the coated textile selected in advance of order placement. Sealed seams cannot be specified if using the moisture barrier lining. The sealing of seams requires testing the textile to ensure acceptance of the heat-sealed tape for performance and aesthetics. For detailed instructions on textile testing and approval, contact your Global representative.

## **TAMPERPROOF**

Tamperproof fasteners can be requested for a higher level of safety. Using tamperproof fasteners ensures the fasteners cannot be interfered with (changed, opened or removed) without use of a special tool. This will prevent the tampering with, or disassembly of the product which could lead to injuries or unsuspecting harm to others. For more detailed information contact your Global representative.

aldon + sonoma

# personal room furniture



The Aldon series offers affordable and personalized furniture solutions for patient or room spaces. Highly durable, Aldon's clean lines and simple design provide built-in quality to meet the demands within healthcare environments. Tops, gables and backs are all field replaceable to meet future requirements for long term performance. The design incorporates smooth surfaces with a straight profile and durable finish options, demonstrating respect for housekeeping and infection control practices. A 3mm PVC edge on the tops, drawer and door fronts provide peace of mind for greater long-term performance. The vast array of product and finish selections allow for individual choices while complimenting the design objective. Aldon is the ideal balance of value and style.



**Features and Benefits**

- Tops standard with 1" thermally fused laminate with coordinating 3mm PVC edge
  - Chassis, back panels, drawer fronts, shelves and doors are constructed of 3/4" thermally fused laminate
  - Constructed with NAUF (no added urea formaldehyde) particle board
  - Laminate finishes are available in a variety of colors
  - Thermofoil and Corian finishes are available on bedside cabinets. See notes for order requirements.
  - All chassis panels and tops can be replaced if damaged
  - Drawers are mounted on high quality precision steel full extension ball bearing slides
  - Handle is attractive, easy-to-grip, arc style. Standard in Tungsten finish.
  - Locks are optional on bedside cabinets, dressers and wardrobes
  - Metal legs and plinth bases available on all models
  - Casters are available on bedside cabinets
  - For proper ventilation, all units have cut-outs with grommets in the back
  - GREENGUARD INDOOR AIR QUALITY CERTIFICATION - in compliance with stringent emission guidelines set out by the Greenguard Environmental Institute under the standards for low emitting products and materials.
- [www.greenguard.org](http://www.greenguard.org).

**TOPS**

- Tops are field replaceable
- Tops on all models are standard with 1" thermally fused laminate with coordinating 3mm PVC edge.
- 1" high pressure laminate tops with coordinating 3mm PVC edge are available on Bedside Cabinets and dressers. For a quotation, please submit a Special Request Form to your Global representative.
- Thermofoil and Corian finishes are available on bedside cabinets only. See right column for finishes.

**CHASSIS**

- Constructed from ¾" thermally fused laminate.
- Return on investment is enhanced through the ability to replace chassis panels or tops should they become damaged.

**BACK**

- Back panels are constructed from ¾" thermally fused laminate
- Back panels are field replaceable should they become damaged

**DRAWERS**

- Drawer fronts are constructed from ¾" thermally fused laminate with 3mm PVC edge.
- Thermofoil finishes are available on bedside cabinets only.
- Mounted on high quality precision steel full extension ball bearing slides.
- Box drawer is 6" high with inside depth of 15.48".
- Drawer interiors are made of PVC-free Black vinyl particle board.
- Soft close drawer is optional, specify **(SF)** at time of order. **Add \$75** per drawer.

**DRAWER INSERTS**

- The optional Bedside Cabinet drawer liner insert is constructed of high impact polystyrene, standard in white. Molded in one piece with no seams or joints to collect dust or bacteria, satin smooth and with rounded corners for easy clean up.
- High impact polystyrene insert liner can be removed for ease of room transfer and cleaning.

**SHELIVING**

- Structural fixed shelves and adjustable shelves are constructed of ¾" thermally fused laminate with coordinating 3mm PVC edge
- Structural fixed shelves and adjustable shelves are supported with metal brackets

**DOORS**

- Constructed of ¾" thermally fused laminate with 3mm pvc edge.
- Mounted utilizing commercial quality hinges that provide a 110° opening span for easy access to personal belongings.

**HANDLES**

- Offered in six styles.
- Handles require a 128mm center point if custom styles are desired.
- Handle style must be specified at time of order.



**A1**  
Arc - Sierra



**B1**  
Bow - Matte Chrome



**B5**  
Bon-Bon - Burnished Brass



**CF**  
Curl - Pewter



**D3**  
Dome - Natural Iron



**RPH1** (add \$66/handle)  
Recessed - Silver

**LOCKS**

- Locks are optional on bedside cabinets, dressers and wardrobes. They must be specified at time of order. Please check each model number for optional locks offered and applicable upcharges.
- Keying is available with random key, please specify **RK**, or keyed alike.
- For key alike numbering sequence, please specify key number 101 - 120. No upcharge.

**EDGE**

- Tops, door fronts and drawer fronts have coordinating 3mm PVC edge
- Fixed and adjustable shelves have coordinating 3mm PVC front edge
- Bedside cabinets have 1" radius at corners

**BASE OPTIONS**

- Metal legs, casters and Plinth base are field replaceable and interchangeable on Aldon where applicable.

**Metal Legs**

- Available on Bedside Cabinets, dressers and wardrobes
- Standard powder coated paint finishes are Black **(BK)**, Latte **(LAB)**, Charcoal **(CG)**, Kalua **(KL)**, Mocha **(MC)**, Nevada **(NV)**, Sierra **(SC)**, Silver **(SL)**, Taupe **(TP)** and Tungsten **(TN)**. Finish must be specified at time of order.
- 3"high. Levelers offer .5" to .75" adjustment for increased stability and leveling.

**Casters**

- Available on bedside cabinets only
- Constructed of commercial quality, swivel dual wheel
- Front casters are manually locking, swivel dual wheel

**Plinth Base**

- Available on bedside cabinets, dressers and wardrobes
- 3" high and standard in thermally fused laminate
- Levelers offer .5" to .75" adjustment for increased stability and leveling.

**VENTILATION**

- All units have cut-outs with grommets in the back for ventilation, reducing odor and bacteria growth

**STANDARD FINISHES**

Absolute Acajou (ACJ)	Noce Biondo (NBL)
Asian Night (ASN)	Noce Grigio (NGL)
Avant Cherry (AWC)	Noce Leggero (NEL)
Avant Honey (AWH)	Noce Medio (NML)
Black (BLK)	Storm Grey (SOG)
Brushed Cobalt (BRC)	Tiger Fruitwood (TFW)
Clear Maple (CMB)	Tiger Walnut (TWL)
Dark Espresso (DES)	Walnut Heights (WHE)
Designer White (DWT)	White Chocolate (WHC)
Hayden Grey (HGT)	Winter Cherry (WCR)
Quartered Mahogany (QTM)	

**THERMOFOIL FINISHES - FRONT & TOP**

- Thermofoil finishes are available on bedside cabinets only. For pricing, please submit a Special Request Form to your Global representative.
- Extended lead times will apply.

**CORIAN FINISHES - TOP**

- Corian finishes are available on bedside cabinets only. See models ending in "CO" (Pricing shown for a minimum order quantity of 6 pieces. To order less than 6 pieces, please contact Customer Care for pricing).
- |                     |                   |
|---------------------|-------------------|
| Antarctica (ANT)    | Linen (LIN)       |
| Bisque (BIS)        | Platinum (PLT)    |
| Bone (BNE)          | Savannah (SAV)    |
| Cameo White (CWH)   | Silver Grey (SGR) |
| Glacier White (GWH) |                   |
- Extended lead times will apply.

**CUSTOM**

- Globalcare invites the opportunity to provide special request quotations for project business. Please contact Customer Care.

**SHIPPING**

- All products are shipped assembled, one per carton, unless otherwise noted



**BEDSIDE CABINETS**



**Bedside Cabinet**



**Bedside Cabinet**



**Bedside Cabinet**



**Bedside Cabinet**



**Bedside Cabinet**

MODEL#	DIMENSIONS	FREIGHT CLASS	WT/LBS.	CUBIC FT.	LIST PRICE	MIN. QTY
--------	------------	---------------	---------	-----------	------------	----------

D x W x H

GCEXBT01CN	22.14 x 21.38 x 30	92.5	96	8.5	<b>\$885</b>	
------------	--------------------	------	----	-----	--------------	--

GCEXBT01CNCO Corian					<b>\$2754</b>	6
------------------------	--	--	--	--	---------------	---

Three Drawers on four casters. Standard with no lock.

- For lock on top drawer, specify **LK**. Add **\$75** list upcharge. Specify random key (**RK**) or key number 101-120.
- For Corian finish see models ending in "**CO**". Pricing shown for a minimum order quantity of 6 pieces. To order less than 6 pieces, please contact Customer Care for pricing. Extended lead times will apply.

GCEXBT01LN	22.14 x 21.38 x 30	92.5	96	8.5	<b>\$967</b>	
------------	--------------------	------	----	-----	--------------	--

GCEXBT01LNCO Corian					<b>\$2827</b>	6
------------------------	--	--	--	--	---------------	---

Three Drawers with metal legs. Standard with no lock.

- For lock on top drawer, specify **LK**. Add **\$75** list upcharge. Specify random key (RK) or key number 101-120.
- For Corian finish see models ending in "**CO**". Pricing shown for a minimum order quantity of 6 pieces. To order less than 6 pieces, please contact Customer Care for pricing. Extended lead times will apply.

GCEXBT01PN	22.14 x 21.38 x 30	92.5	96	8.5	<b>\$904</b>	
------------	--------------------	------	----	-----	--------------	--

GCEXBT01PNCO Corian					<b>\$2769</b>	6
------------------------	--	--	--	--	---------------	---

Three Drawers on plinth base. Standard with no lock.

- For lock on top drawer, specify **LK**. Add **\$75** list upcharge. Specify random key (RK) or key number 101-120.
- For Corian finish see models ending in "**CO**". Pricing shown for a minimum order quantity of 6 pieces. To order less than 6 pieces, please contact Customer Care for pricing. Extended lead times will apply.

GCEXBT02CLN	22.14 x 21.38 x 30	92.5	95	8.5	<b>\$1138</b>	
-------------	--------------------	------	----	-----	---------------	--

GCEXBT02CLNCO Corian					<b>\$2968</b>	6
-------------------------	--	--	--	--	---------------	---

Pull out shelf, Top position drawer, one **LEFT** opening door (hinges on left) with 3 position adjustable shelf behind door, on four casters. Standard with no locks.

- For lock on drawer, specify **LK**. Add **\$75** list upcharge.
- For lock on door, specify **L3**. Add **\$75** list upcharge.
- For locks on drawer and door, specify **L5**. Add **\$146** list upcharge.
- Specify random key (**RK**) or key number 101-120.
- For Corian finish see models ending in "**CO**". Pricing shown for a minimum order quantity of 6 pieces. To order less than 6 pieces, please contact Customer Care for pricing. Extended lead times will apply.

GCEXBT02CRN	22.14 x 21.38 x 30	92.5	95	8.5	<b>\$1138</b>	
-------------	--------------------	------	----	-----	---------------	--

GCEXBT02CRNCO Corian					<b>\$2968</b>	6
-------------------------	--	--	--	--	---------------	---

Pull out shelf, Top position drawer, one **RIGHT** opening door (hinges on right) with 3 position adjustable shelf behind door, on four casters. Standard with no locks.

- For lock on drawer, specify **LK**. Add **\$75** list upcharge.
- For lock on door, specify **L4**. Add **\$75** list upcharge.
- For locks on drawer and door, specify **L6**. Add **\$146** list upcharge.
- Specify random key (RK) or key number 101-120.
- For Corian finish see models ending in "**CO**". Pricing shown for a minimum order quantity of 6 pieces. To order less than 6 pieces, please contact Customer Care for pricing. Extended lead times will apply.

BEDSIDE CABINETS

MODEL# DIMENSIONS FREIGHT CLASS WT/LBS. CUBIC FT. LIST PRICE MIN. QTY

D x W x H

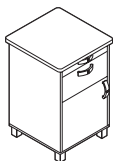

Bedside Cabinet

GCEXBT02LLN	22.14 x 21.38 x 30	92.5	95	8.5	<b>\$1234</b>	
GCEXBT02LLNCO Corian	22.14 x 21.38 x 30	92.5	95	8.5	<b>\$3051</b>	6

Pull out shelf, Top position drawer, one **LEFT** opening door (hinges on left) with 3 position adjustable shelf behind door, with metal legs. Standard with no locks.

- For lock on drawer, specify **LK**. Add **\$75** list upcharge.
- For lock on door, specify **L3**. Add **\$75** list upcharge.
- For locks on drawer and door, specify **L5**. Add **\$146** list upcharge.
- Specify random key (RK) or key number 101-120.
- For Corian finish see models ending in "**CO**". Pricing shown for a minimum order quantity of 6 pieces. To order less than 6 pieces, please contact Customer Care for pricing. Extended lead times will apply.

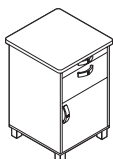

Bedside Cabinet

GCEXBT02LRN	22.14 x 21.38 x 30	92.5	95	8.5	<b>\$1234</b>	
GCEXBT02LRNCO Corian	22.14 x 21.38 x 30	92.5	95	8.5	<b>\$3051</b>	6

Pull out shelf, Top position drawer, one **RIGHT** opening door (hinges on right) with 3 position adjustable shelf behind door, with metal legs. Standard with no locks.

- For lock on drawer, specify **LK**. Add **\$75** list upcharge.
- For lock on door, specify **L4**. Add **\$75** list upcharge.
- For locks on drawer and door, specify **L6**. Add **\$146** list upcharge.
- Specify random key (RK) or key number 101-120.
- For Corian finish see models ending in "**CO**". Pricing shown for a minimum order quantity of 6 pieces. To order less than 6 pieces, please contact Customer Care for pricing. Extended lead times will apply.



Bedside Cabinet

GCEXBT02PLN	22.14 x 21.38 x 30	92.5	95	8.5	<b>\$1196</b>	
GCEXBT02PLNCO Corian					<b>\$3019</b>	6

Pull out shelf, Top position drawer, one **LEFT** opening door (hinges on left) with 3 position adjustable shelf behind door, on plinth base. Standard with no locks.

- For lock on drawer, specify **LK**. Add **\$75** list upcharge.
- For lock on door, specify **L3**. Add **\$75** list upcharge.
- For locks on drawer and door, specify **L5**. Add **\$146** list upcharge.
- Specify random key (RK) or key number 101-120.
- For Corian finish see models ending in "**CO**". Pricing shown for a minimum order quantity of 6 pieces. To order less than 6 pieces, please contact Customer Care for pricing. Extended lead times will apply.



Bedside Cabinet

GCEXBT02PRN	22.14 x 21.38 x 30	92.5	95	8.5	<b>\$1196</b>	
GCEXBT02PRNCO Corian					<b>\$3019</b>	6

Pull out shelf, Top position drawer, one **RIGHT** opening door (hinges on right) with 3 position adjustable shelf behind door, on plinth base. Standard with no locks.

- For lock on drawer, specify **LK**. Add **\$75** list upcharge.
- For lock on door, specify **L4**. Add **\$75** list upcharge.
- For locks on drawer and door, specify **L6**. Add **\$146** list upcharge.
- Specify random key (RK) or key number 101-120.
- For Corian finish see models ending in "**CO**". Pricing shown for a minimum order quantity of 6 pieces. To order less than 6 pieces, please contact Customer Care for pricing. Extended lead times will apply.

**BEDSIDE CABINETS**



**Bedside Cabinet**



**Bedside Cabinet**

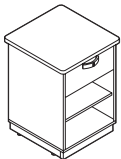

**Bedside Cabinet**



**Bedside Cabinet**

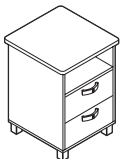

**Bedside Cabinet**

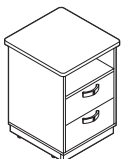

**Bedside Cabinet**

MODEL#	DIMENSIONS	FREIGHT CLASS	WT/LBS.	CUBIC FT.	LIST PRICE	MIN. QTY
--------	------------	---------------	---------	-----------	------------	----------

D x W x H

GCEXBT03CN	22.14 x 21.38 x 30	92.5	87	8.5	<b>\$744</b>	
------------	--------------------	------	----	-----	--------------	--

GCEXBT03CNCO Corian	22.14 x 21.38 x 30				<b>\$2637</b>	6
------------------------	--------------------	--	--	--	---------------	---

One drawer and one open 3 position adjustable shelf, on four casters. Standard with no lock.

- For lock on top drawer, specify **LK**. Add **\$75** list upcharge. Specify random key (RK) or key number 101-120.
- For Corian finish see models ending in "**CO**". Pricing shown for a minimum order quantity of 6 pieces. To order less than 6 pieces, please contact Customer Care for pricing. Extended lead times will apply.

GCEXBT03LN	22.14 x 21.38 x 30	92.5	87	8.5	<b>\$822</b>	
------------	--------------------	------	----	-----	--------------	--

GCEXBT03LNCO Corian	22.14 x 21.38 x 30				<b>\$2699</b>	6
------------------------	--------------------	--	--	--	---------------	---

One drawer and one open 3 position adjustable shelf, on metal legs. Standard with no lock.

- For lock on top drawer, specify **LK**. Add **\$75** list upcharge. Specify random key (RK) or key number 101-120.
- For Corian finish see models ending in "**CO**". Pricing shown for a minimum order quantity of 6 pieces. To order less than 6 pieces, please contact Customer Care for pricing. Extended lead times will apply.

GCEXBT03PN	22.14 x 21.38 x 30	92.5	87	8.5	<b>\$773</b>	
------------	--------------------	------	----	-----	--------------	--

GCEXBT03PNCO Corian	22.14 x 21.38 x 30				<b>\$2660</b>	6
------------------------	--------------------	--	--	--	---------------	---

One drawer and one open 3 position adjustable shelf, on plinth base. Standard with no lock.

- For lock on top drawer, specify **LK**. Add **\$75** list upcharge. Specify random key (RK) or key number 101-120.
- For Corian finish see models ending in "**CO**". Pricing shown for a minimum order quantity of 6 pieces. To order less than 6 pieces, please contact Customer Care for pricing. Extended lead times will apply.

GCEXBT04CN	22.14 x 21.38 x 30	92.5	94	8.5	<b>\$852</b>	
------------	--------------------	------	----	-----	--------------	--

GCEXBT04CNCO Corian	22.14 x 21.38 x 30				<b>\$2727</b>	6
------------------------	--------------------	--	--	--	---------------	---

One open fixed shelf and two drawers, on four casters. Standard with no lock.

- For lock on top drawer, specify **LK**. Add **\$75** list upcharge. Specify random key (RK) or key number 101-120.
- For Corian finish see models ending in "**CO**". Pricing shown for a minimum order quantity of 6 pieces. To order less than 6 pieces, please contact Customer Care for pricing. Extended lead times will apply.

GCEXBT04LN	22.14 x 21.38 x 30	92.5	94	8.5	<b>\$928</b>	
------------	--------------------	------	----	-----	--------------	--

GCEXBT04LNCO Corian	22.14 x 21.38 x 30				<b>\$2792</b>	6
------------------------	--------------------	--	--	--	---------------	---

One open fixed shelf and two drawers, with metal legs. Standard with no lock.

- For lock on top drawer, specify **LK**. Add **\$75** list upcharge. Specify random key (RK) or key number 101-120.
- For Corian finish see models ending in "**CO**". Pricing shown for a minimum order quantity of 6 pieces. To order less than 6 pieces, please contact Customer Care for pricing. Extended lead times will apply.

GCEXBT04PN	22.14 x 21.38 x 30	92.5	94	8.5	<b>\$876</b>	
------------	--------------------	------	----	-----	--------------	--

GCEXBT04PNCO Corian	22.14 x 21.38 x 30				<b>\$2750</b>	6
------------------------	--------------------	--	--	--	---------------	---

One open fixed shelf and two drawers, on plinth base. Standard with no lock.

- For lock on top drawer, specify **LK**. Add **\$75** list upcharge. Specify random key (RK) or key number 101-120.
- For Corian finish see models ending in "**CO**". Pricing shown for a minimum order quantity of 6 pieces. To order less than 6 pieces, please contact Customer Care for pricing. Extended lead times will apply.

BEDSIDE CABINETS



Bedside Cabinet

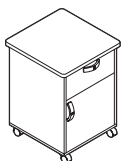

Bedside Cabinet

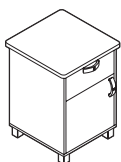

Bedside Cabinet

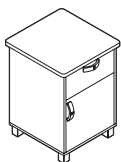

Bedside Cabinet

MODEL#	DIMENSIONS	FREIGHT CLASS	WT/LBS.	CUBIC FT.	LIST PRICE	MIN. QTY
--------	------------	---------------	---------	-----------	------------	----------

D x W x H

GCEXBT06CLN	22.14 x 21.38 x 30	92.5	92	8.5	<b>\$841</b>	
GCEXBT06CLNCO Corian	22.14 x 21.38 x 30				<b>\$2716</b>	6

Top position drawer, one **LEFT** opening door (hinges on left) with 3 position adjustable shelf behind door, on four casters. Standard with no locks.

- For lock on drawer, specify **LK**. Add **\$75** list upcharge.
- For lock on door, specify **L3**. Add **\$75** list upcharge.
- For locks on drawer and door, specify **L5**. Add **\$146** list upcharge.
- Specify random key (RK) or key number 101-120.
- For Corian finish see models ending in "**CO**". Pricing shown for a minimum order quantity of 6 pieces. To order less than 6 pieces, please contact Customer Care for pricing. Extended lead times will apply.

GCEXBT06CRN	22.14 x 21.38 x 30	92.5	92	8.5	<b>\$841</b>	
GCEXBT06CRNCO Corian	22.14 x 21.38 x 30				<b>\$2716</b>	6

Top position drawer, one **RIGHT** opening door (hinges on right) with 3 position adjustable shelf behind door, on four casters. Standard with no locks.

- For lock on drawer, specify **LK**. Add **\$75** list upcharge.
- For lock on door, specify **L4**. Add **\$75** list upcharge.
- For locks on drawer and door, specify **L6**. Add **\$146** list upcharge.
- Specify random key (RK) or key number 101-120.
- For Corian finish see models ending in "**CO**". Pricing shown for a minimum order quantity of 6 pieces. To order less than 6 pieces, please contact Customer Care for pricing. Extended lead times will apply.

GCEXBT06LLN	22.14 x 21.38 x 30	92.5	92	8.5	<b>\$920</b>	
GCEXBT06LLNCO Corian	22.14 x 21.38 x 30				<b>\$2782</b>	6

Top position drawer, one **LEFT** opening door (hinges on left) with 3 position adjustable shelf behind door, with metal legs. Standard with no locks.

- For lock on drawer, specify **LK**. Add **\$75** list upcharge.
- For lock on door, specify **L3**. Add **\$75** list upcharge.
- For locks on drawer and door, specify **L5**. Add **\$146** list upcharge.
- Specify random key (RK) or key number 101-120.
- For Corian finish see models ending in "**CO**". Pricing shown for a minimum order quantity of 6 pieces. To order less than 6 pieces, please contact Customer Care for pricing. Extended lead times will apply.

GCEXBT06LRN	22.14 x 21.38 x 30	92.5	92	8.5	<b>\$920</b>	
GCEXBT06LRNCO Corian	22.14 x 21.38 x 30				<b>\$2105</b>	6

Top position drawer, one **RIGHT** opening door (hinges on right) with 3 position adjustable shelf behind door, with metal legs. Standard with no locks.

- For lock on drawer, specify **LK**. Add **\$75** list upcharge.
- For lock on door, specify **L4**. Add **\$75** list upcharge.
- For locks on drawer and door, specify **L6**. Add **\$146** list upcharge.
- Specify random key (RK) or key number 101-120.
- For Corian finish see models ending in "**CO**". Pricing shown for a minimum order quantity of 6 pieces. To order less than 6 pieces, please contact Customer Care for pricing. Extended lead times will apply.

**BEDSIDE CABINETS**

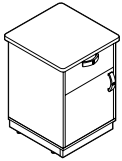

**Bedside Cabinet**

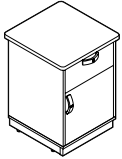

**Bedside Cabinet**

MODEL#	DIMENSIONS	FREIGHT CLASS	WT/LBS.	CUBIC FT.	LIST PRICE	MIN. QTY
--------	------------	---------------	---------	-----------	------------	----------

D x W x H

GCEXBT06PLN	22.14 x 21.38 x 30	92.5	92	8.5	<b>\$872</b>	
-------------	--------------------	------	----	-----	--------------	--

GCEXBT06PLNCO Corian	22.14 x 21.38 x 30				<b>\$2075</b>	6
-------------------------	--------------------	--	--	--	---------------	---

Top position drawer, one **LEFT** opening door (hinges on left) with 3 position adjustable shelf behind door, on plinth base. Standard with no locks.

- For lock on drawer, specify **LK**. Add **\$75** list upcharge.
- For lock on door, specify **L3**. Add **\$75** list upcharge.
- For locks on drawer and door, specify **L5**. Add **\$146** list upcharge.
- Specify random key (RK) or key number 101-120.
- For Corian finish see models ending in "**CO**". Pricing shown for a minimum order quantity of 6 pieces. To order less than 6 pieces, please contact Customer Care for pricing. Extended lead times will apply.

GCEXBT06PRN	22.14 x 21.38 x 30	92.5	92	8.5	<b>\$872</b>	
-------------	--------------------	------	----	-----	--------------	--

GCEXBT06PRNCO Corian	22.14 x 21.38 x 30				<b>\$2075</b>	6
-------------------------	--------------------	--	--	--	---------------	---

Top position drawer, one **RIGHT** opening door (hinges on right) with 3 position adjustable shelf behind door, on plinth base. Standard with no locks.

- For lock on drawer, specify **LK**. Add **\$75** list upcharge.
- For lock on door, specify **L4**. Add **\$75** list upcharge.
- For locks on drawer and door, specify **L6**. Add **\$146** list upcharge.
- Specify random key (RK) or key number 101-120.
- For Corian finish see models ending in "**CO**". Pricing shown for a minimum order quantity of 6 pieces. To order less than 6 pieces, please contact Customer Care for pricing. Extended lead times will apply.

**DRESSERS**

MODEL#	DIMENSIONS	FREIGHT CLASS	WT/LBS.	CUBIC FT.	LIST PRICE
--------	------------	---------------	---------	-----------	------------

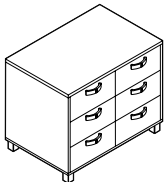

**Double Dresser**

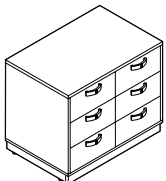

**Double Dresser**

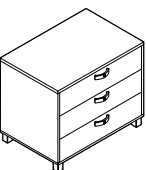

**3 Drawer Dresser**

GCEXDD01LN	24.13 x 36.19 x 30	92.5	180	18	<b>\$1459</b>
------------	--------------------	------	-----	----	---------------

Three drawers on each side, on metal legs. Standard with no locks.

- For lock on top right drawer, specify **LR**. Add **\$75** list upcharge.
- For lock on top left drawer, specify **LL**. Add **\$75** list upcharge.
- For lock on top right and left drawers, specify **LB**. Add **\$146** list upcharge.
- Specify random key (RK) or key number 101-120.

GCEXDD01PN	24.13 x 36.19 x 30	92.5	180	18	<b>\$1380</b>
------------	--------------------	------	-----	----	---------------

Three drawers on each side, on plinth base. Standard with no locks.

- For lock on top right drawer, specify **LR**. Add **\$75** list upcharge.
- For lock on top left drawer, specify **LL**. Add **\$75** list upcharge.
- For lock on top right and left drawers, specify **LB**. Add **\$146** list upcharge.
- Specify random key (RK) or key number 101-120.

GCEXDR02LN	24.13 x 35.63 x 30	100	142	17	<b>\$1170</b>
------------	--------------------	-----	-----	----	---------------

Three drawers on metal legs. Standard with no lock.

- For lock on top drawer, specify **LK**. Add **\$75** list upcharge.

DRESSERS

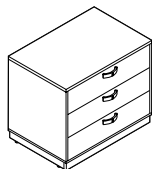

3 Drawer Dresser

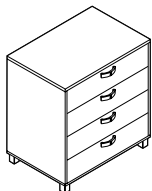

4 Drawer Dresser

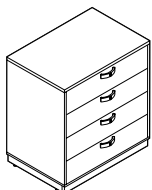

4 Drawer Dresser

MODEL#	DIMENSIONS	FREIGHT CLASS	WT/LBS.	CUBIC FT.	LIST PRICE
--------	------------	---------------	---------	-----------	------------

D x W x H

GCEXDR02PN	24.13 x 35.63 x 30	100	142	17	\$1092
------------	--------------------	-----	-----	----	--------

Three drawers on plinth base. Standard with no lock.  
 • For lock on top drawer, specify **LK**. Add **\$75** list upcharge.

GCEXDR07LN	24.13 x 35.63 x 38.5	125	153	22	\$1347
------------	----------------------	-----	-----	----	--------

Four drawers on metal legs. Standard with no lock.  
 • For lock on top drawer, specify **LK**. Add **\$75** list upcharge.

GCEXDR07PN	24.13 x 35.63 x 38.5	125	153	22	\$1307
------------	----------------------	-----	-----	----	--------

Four drawers on plinth base. Standard with no lock.  
 • For lock on top drawer, specify **LK**. Add **\$75** list upcharge.

BEDSIDE DRAWER LINER

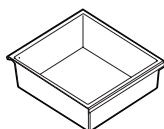

Bedside Drawer Liner

MODEL#	DIMENSIONS	FREIGHT CLASS	WT/LBS.	CUBIC FT.	LIST PRICE
--------	------------	---------------	---------	-----------	------------

GCEXLLP01	15.5 x 16.5 x 4.5	250	3.5	1	\$108
-----------	-------------------	-----	-----	---	-------

High impact polystyrene insert liner for Bedside Cabinet drawers. Can be removed for ease of room transfer and cleaning.

**WARDROBE CABINETS**

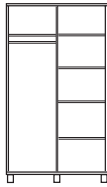
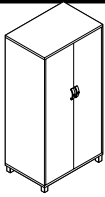

**Wardrobe Cabinet**

MODEL#	DIMENSIONS D x W x H	FREIGHT CLASS	WT/LBS.	CUBIC FT.	LIST PRICE
GCEXWD03LN	24.13 x 35.63 x 72	125	305	43	<b>\$2143</b>

Inside dimensions:

- Left side top shelf: 12.85"
- Left side clothing rail area: 53.2"
- Right side with adjustable shelves area: 66.59"

Divided wardrobe with J-style safety clothing rail and shelves, on 5 metal legs. Two doors covering interior divided in two with an upper fixed shelf and J-style safety clothing rail on the left side. The right side has 4 adjustable shelves. Two anti-tip brackets are included for greater security. Standard with no lock. Shipped assembled, 1 per carton.

- For one lock fastening both doors, specify **LB**. Add **\$75** list upcharge. Specify random key (**RK**) or key number 101-120.

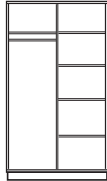
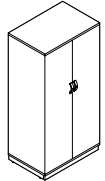

**Wardrobe Cabinet**

GCEXWD03PN	24.13 x 35.63 x 72	125	305	43	<b>\$2108</b>
------------	--------------------	-----	-----	----	---------------

Inside dimensions:

- Left side top shelf: 12.85"
- Left side clothing rail area: 53.2"
- Right side with adjustable shelves area: 66.59"

Divided wardrobe with J-style safety clothing rail and shelves, on plinth base. Two doors covering interior divided in two with an upper fixed shelf and J-style safety clothing rail on the left side. The right side has 4 adjustable shelves. Two Anti-tip brackets are included for greater security. Standard with no lock. Shipped assembled, 1 per carton.

- For one lock fastening both doors, specify **LB**. Add **\$75** list upcharge. Specify random key (**RK**) or key number 101-120.

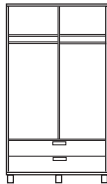
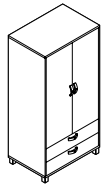

**Wardrobe Cabinet**

GCEXWD04LN	24.13 x 35.63 x 72	125	316	43	<b>\$2304</b>
------------	--------------------	-----	-----	----	---------------

Inside dimensions:

- Left side top shelf: 7"
- Left side clothing rail area: 42"
- Right side top shelf: 7"
- Right side clothing rail area: 42"
- Top drawer: 8.25"
- Lower drawer: 8.25"

Divided wardrobe with J-style safety clothing rail and two full drawers below, on 5 metal legs. Two doors covering interior divided in two with an upper fixed shelf and J-style safety clothing rail on both sides. Two exposed drawers below. Two anti-tip brackets are included for greater security. Standard with no locks. Shipped assembled, 1 per carton.

- For lock on right door, specify **L4**. Add **\$75** list upcharge.
- For lock on left door, specify **L3**. Add **\$75** list upcharge.
- For lock on both right and left doors, specify **L2**. Add **\$146** list upcharge.
- For lock on top drawer, specify **LK**. Add **\$75** list upcharge.
- For lock on right door and top drawer, specify **L6**. Add **\$146** list upcharge.
- For lock on left door and top drawer, specify **L5**. Add **\$146** list upcharge.
- For lock on right door, left door and top drawer, specify **L9**. Add **\$217** list upcharge.
- Specify random key (**RK**) or key number 101-120.

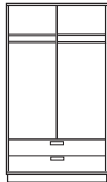
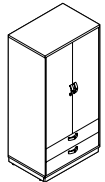

**Wardrobe Cabinet**

GCEXWD04PN	24.13 x 35.63 x 72	125	316	43	<b>\$2274</b>
------------	--------------------	-----	-----	----	---------------

Inside dimensions:

- Left side top shelf: 7"
- Left side clothing rail area: 42"
- Right side top shelf: 7"
- Right side clothing rail area: 42"
- Top drawer: 8.25"
- Lower drawer: 8.25"

Divided wardrobe with J-style safety clothing rail and two full drawers below, on plinth base. Two doors covering interior divided in two with an upper fixed shelf and J-style safety clothing rail on both sides. Two exposed drawers below. Two anti-tip brackets are included for greater security. Standard with no locks. Shipped assembled, 1 per carton.

- For lock on right door, specify **L4**. Add **\$75** list upcharge.
- For lock on left door, specify **L3**. Add **\$75** list upcharge.
- For lock on both right and left doors, specify **L2**. Add **\$146** list upcharge.
- For lock on top drawer, specify **LK**. Add **\$75** list upcharge.
- For lock on right door and top drawer, specify **L6**. Add **\$146** list upcharge.
- For lock on left door and top drawer, specify **L5**. Add **\$146** list upcharge.
- For lock on right door, left door and top drawer, specify **L9**. Add **\$217** list upcharge.
- Specify random key (**RK**) or key number 101-120.

## WARDROBE CABINETS

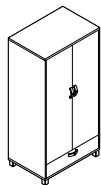

Wardrobe Cabinet

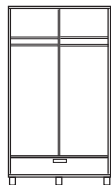

MODEL#	DIMENSIONS D x W x H	FREIGHT CLASS	WT/LBS.	CUBIC FT.	LIST PRICE
--------	-------------------------	---------------	---------	-----------	------------

GCEXWD05LN	24.13 x 35.63 x 72	125	305	43	<b>\$2222</b>
------------	--------------------	-----	-----	----	---------------

Inside dimensions:

- Left side top shelf: 7"
- Left side clothing rail area: 42"
- Right side top shelf: 7"
- Right side clothing rail area: 42"
- Top drawer: 8.25"
- Lower drawer: 8.25"

Divided wardrobe with J-style safety clothing rail and two full drawers below, on 5 metal legs. Two doors covering interior divided in two with an upper fixed shelf and J-style safety clothing rail on both sides. Two exposed drawers below. Two anti-tip brackets are included for greater security. Standard with no locks. Shipped assembled, 1 per carton.

- For lock on right door, specify **L4**. Add **\$75** list upcharge.
- For lock on left door, specify **L3**. Add **\$75** list upcharge.
- For lock on both right and left doors, specify **L2**. Add **\$146** list upcharge.
- For lock on drawer, specify **LK**. Add **\$75** list upcharge.
- For lock on right door and drawer, specify **L6**. Add **\$146** list upcharge.
- For lock on left door and drawer, specify **L5**. Add **\$146** list upcharge.
- For locks on right door, left door and drawer, specify **L9**. Add **\$217** list upcharge.
- Specify random key (**RK**) or key number 101-120.

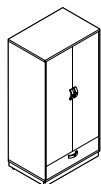

Wardrobe Cabinet

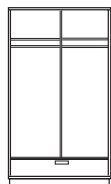

GCEXWD05PN	24.13 x 35.63 x 72	125	305	43	<b>\$2185</b>
------------	--------------------	-----	-----	----	---------------

Inside dimensions:

- Left side top shelf: 7"
- Left side clothing rail area: 42"
- Right side top shelf: 7"
- Right side clothing rail area: 42"
- Top drawer: 8.25"
- Lower drawer: 8.25"

Divided wardrobe with J-style safety clothing rail and two full drawers below, on plinth base. Two doors covering interior divided in two with an upper fixed shelf and J-style safety clothing rail on both sides. Two exposed drawers below. Two anti-tip brackets are included for greater security. Standard with no locks. Shipped assembled, 1 per carton.

- For lock on right door, specify **L4**. Add **\$75** list upcharge.
- For lock on left door, specify **L3**. Add **\$75** list upcharge.
- For lock on both right and left doors, specify **L2**. Add **\$146** list upcharge.
- For lock on drawer, specify **LK**. Add **\$75** list upcharge.
- For lock on right door and drawer, specify **L6**. Add **\$146** list upcharge.
- For lock on left door and drawer, specify **L5**. Add **\$146** list upcharge.
- For locks on right door, left door and drawer, specify **L9**. Add **\$217** list upcharge.
- Specify random key (**RK**) or key number 101-120.



**NARROW WARDROBE CABINETS**

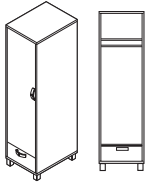

**Narrow Wardrobe Cabinet**

MODEL#	DIMENSIONS D x W x H	FREIGHT CLASS	WT/LBS.	CUBIC FT.	LIST PRICE
GCEXWN01LLN	24.13 x 18.63 x 72	150	131	24	<b>\$1752</b>

- Inside dimensions:
- Top shelf: 7"
  - Clothing rail area: 50.4"
  - Drawer: 8.25"

Narrow wardrobe with J-style safety clothing rail and drawer below, on four metal legs. One **left** door (hinges on left) covering upper fixed shelf and J-style safety clothing rail. One exposed drawer below. Two anti-tip brackets are included for greater security. Standard with no locks. Shipped assembled, 1 per carton..

- For lock on drawer, specify **LK**. Add **\$75** list upcharge.
- For lock on door, specify **L3**. Add **\$75** list upcharge.
- For locks on door and drawer, specify **L5**. Add **\$146** list upcharge.
- Specify random key (**RK**) or key number 101-120.

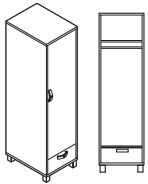

**Narrow Wardrobe Cabinet**

GCEXWN01LRN	24.13 x 18.5 x 72	150	131	24	<b>\$1752</b>
-------------	-------------------	-----	-----	----	---------------

- Inside dimensions:
- Top shelf: 7"
  - Clothing rail area: 50.4"
  - Drawer: 8.25"

Narrow wardrobe with J-style safety clothing rail and drawer below, on four metal legs. One **right** door (hinges on right) covering upper fixed shelf and J-style safety clothing rail. One exposed drawer below. Two anti-tip brackets are included for greater security. Standard with no locks. Shipped assembled, 1 per carton.

- For lock on drawer, specify **LK**. Add **\$75** list upcharge.
- For lock on door, specify **L4**. Add **\$75** list upcharge.
- For locks on door and drawer, specify **L6**. Add **\$146** list upcharge.
- Specify random key (**RK**) or key number 101-120.

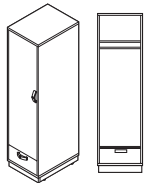

**Narrow Wardrobe Cabinet**

GCEXWN01PLN	24.13 x 18.63 x 72	150	131	24	<b>\$1700</b>
-------------	--------------------	-----	-----	----	---------------

- Inside dimensions:
- Top shelf: 7"
  - Clothing rail area: 50.4"
  - Drawer: 8.25"

Narrow wardrobe with J-style safety clothing rail and drawer below, on plinth base. One **left** door (hinges on left) covering upper fixed shelf and J-style safety clothing rail. One exposed drawer below. Two anti-tip brackets are included for greater security. Standard with no locks. Shipped assembled, 1 per carton.

- For lock on drawer, specify **LK**. Add **\$75** list upcharge.
- For lock on door, specify **L3**. Add **\$75** list upcharge.
- For locks on door and drawer, specify **L5**. Add **\$146** list upcharge.
- Specify random key (**RK**) or key number 101-120.

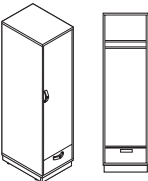

**Narrow Wardrobe Cabinet**

GCEXWN01PRN	24 x 18.5 x 72	150	131	24	<b>\$1700</b>
-------------	----------------	-----	-----	----	---------------

- Inside dimensions:
- Top shelf: 7"
  - Clothing rail area: 50.4"
  - Drawer: 8.25"

Narrow wardrobe with J-style safety clothing rail and drawer below, on plinth base. One **right** door (hinges on right) covering upper fixed shelf and J-style safety clothing rail. One exposed drawer below. Two anti-tip brackets are included for greater security. Standard with no locks. Shipped assembled, 1 per carton.

- For lock on drawer, specify **LK**. Add **\$75** list upcharge.
- For lock on door, specify **L4**. Add **\$75** list upcharge.
- For locks on door and drawer, specify **L6**. Add **\$146** list upcharge.
- Specify random key (**RK**) or key number 101-120.

## NARROW WARDROBE CABINETS

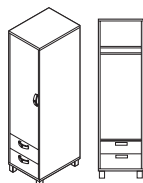

Narrow Wardrobe Cabinet

MODEL#	D x W x H	FREIGHT CLASS	WT/LBS.	CUBIC FT.	LIST PRICE
GCEXWN02LLN	24.13 x 18.63 x 72	150	136	24	<b>\$1838</b>

Inside dimensions:

- Top shelf: 7"
- Clothing rail area: 42"
- Top drawer: 8.25"
- Lower drawer: 8.25"

Narrow wardrobe with J-style safety clothing rail and two drawers below, on four metal legs. One **left** door (hinges on left) covering upper fixed shelf and J-style safety clothing rail. Two exposed drawers below. Two anti-tip brackets are included for greater security. Standard with no locks. Shipped assembled, 1 per carton.

- For lock on top drawer, specify **LK**. Add **\$75** list upcharge.
- For lock on door, specify **L3**. Add **\$75** list upcharge.
- For locks on door and top drawer, specify **L5**. Add **\$146** list upcharge.
- Specify random key (**RK**) or key number 101-120.

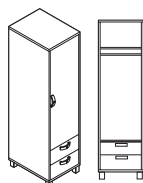

Narrow Wardrobe Cabinet

GCEXWN02LRN	24.13 x 18.63 x 72	150	136	24	<b>\$1838</b>
-------------	--------------------	-----	-----	----	---------------

Inside dimensions:

- Top shelf: 7"
- Clothing rail area: 42"
- Top drawer: 8.25"
- Lower drawer: 8.25"

Narrow wardrobe with J-style safety clothing rail and two drawers below, on four metal legs. One **right** door (hinges on right) covering upper fixed shelf and J-style safety clothing rail. Two exposed drawers below. Two anti-tip brackets are included for greater security. Standard with no locks. Shipped assembled, 1 per carton.

- For lock on top drawer, specify **LK**. Add **\$75** list upcharge.
- For lock on door, specify **L4**. Add **\$75** list upcharge.
- For locks on door and top drawer, specify **L6**. Add **\$146** list upcharge.
- Specify random key (**RK**) or key number 101-120.

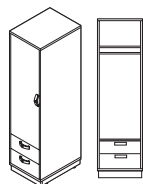

Narrow Wardrobe Cabinet

GCEXWN02PLN	24.13 x 18.63 x 72	150	136	24	<b>\$1783</b>
-------------	--------------------	-----	-----	----	---------------

Inside dimensions:

- Top shelf: 7"
- Clothing rail area: 42"
- Top drawer: 8.25"
- Lower drawer: 8.25"

Narrow wardrobe with J-style safety clothing rail and two drawers below, on plinth base. One **left** door (hinges on left) covering upper fixed shelf and J-style safety clothing rail. Two exposed drawers below. Two anti-tip brackets are included for greater security. Standard with no locks. Shipped assembled, 1 per carton.

- For lock on top drawer, specify **LK**. Add **\$75** list upcharge.
- For lock on door, specify **L3**. Add **\$75** list upcharge.
- For locks on door and top drawer, specify **L5**. Add **\$146** list upcharge.
- Specify random key (**RK**) or key number 101-120.

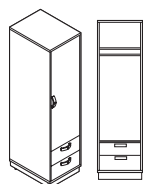

Narrow Wardrobe Cabinet

GCEXWN02PRN	24.13 x 18.63 x 72	150	136	24	<b>\$1783</b>
-------------	--------------------	-----	-----	----	---------------

Inside dimensions:

- Top shelf: 7"
- Clothing rail area: 42"
- Top drawer: 8.25"
- Lower drawer: 8.25"

Narrow wardrobe with J-style safety clothing rail and two drawers below, on plinth base. One **right** door (hinges on right) covering upper fixed shelf and J-style safety clothing rail. Two exposed drawers below. Two anti-tip brackets are included for greater security. Standard with no locks. Shipped assembled, 1 per carton.

- For lock on top drawer, specify **LK**. Add **\$75** list upcharge.
- For lock on door, specify **L4**. Add **\$75** list upcharge.
- For locks on door and top drawer, specify **L6**. Add **\$146** list upcharge.
- Specify random key (**RK**) or key number 101-120.

## NARROW WARDROBE CABINETS

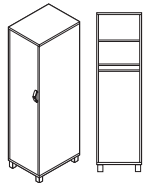

Narrow Wardrobe Cabinet

MODEL#	DIMENSIONS D x W x H	FREIGHT CLASS	WT/LBS.	CUBIC FT.	LIST PRICE
GCEXWN03LLN	24 x 18.5 x 72	150	131	24	<b>\$1670</b>

Inside dimensions:

- Adjustable shelf: 11.69"
- Fixed shelf: 11.69"
- Clothing rail area: 42"

Narrow wardrobe with shelves and J-style safety clothing rail, on metal legs. One **left** door (hinges on left) covering interior with one 3-position adjustable shelf and a fixed shelf above the J-style safety clothing rail. Two anti-tip brackets are included for greater security. Standard with no lock. Shipped assembled, 1 per carton.

- For lock on door, specify **L3**. Add **\$75** list upcharge.

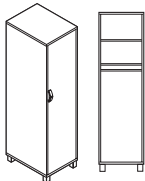

Narrow Wardrobe Cabinet

GCEXWN03LRN	24.13 x 18.63 x 72	150	131	24	<b>\$1670</b>
-------------	--------------------	-----	-----	----	---------------

Inside dimensions:

- Adjustable shelf: 11.69"
- Fixed shelf: 11.69"
- Clothing rail area: 42"

Narrow wardrobe with shelves and J-style safety clothing rail, on metal legs. One **right** door (hinges on right) covering interior with one 3-position adjustable shelf and a fixed shelf above the J-style safety clothing rail. Two anti-tip brackets are included for greater security. Standard with no lock. Shipped assembled, 1 per carton.

- For lock on door, specify **L4**. Add **\$75** list upcharge.

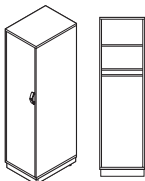

Narrow Wardrobe Cabinet

GCEXWN03PLN	24.13 x 18.63 x 72	150	131	24	<b>\$1602</b>
-------------	--------------------	-----	-----	----	---------------

Inside dimensions:

- Adjustable shelf: 11.69"
- Fixed shelf: 11.69"
- Clothing rail area: 42"

Narrow wardrobe with shelves and J-style safety clothing rail, on plinth base. One **left** door (hinges on left) covering interior with one 3-position adjustable shelf and a fixed shelf above the J-style safety clothing rail. Two anti-tip brackets are included for greater security. Standard with no lock. Shipped assembled, 1 per carton.

- For lock on door, specify **L3**. Add **\$75** list upcharge.

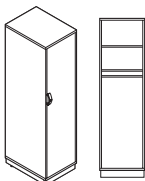

Narrow Wardrobe Cabinet

GCEXWN03PRN	24.13 x 18.63 x 72	150	131	24	<b>\$1602</b>
-------------	--------------------	-----	-----	----	---------------

Inside dimensions:

- Adjustable shelf: 11.69"
- Fixed shelf: 11.69"
- Clothing rail area: 42"

Narrow wardrobe with shelves and J-style safety clothing rail, on plinth base. One **right** door (hinges on right) covering interior with one 3-position adjustable shelf and a fixed shelf above the J-style safety clothing rail. Two anti-tip brackets are included for greater security. Standard with no lock. Shipped assembled, 1 per carton.

- For lock on door, specify **L4**. Add **\$75** list upcharge.



Replacement Lock Set

AL00975COREK	--	-	--	--	<b>\$56</b>
--------------	----	---	----	----	-------------

Replacement core and key.



Replacement Key

AL00975KEY	--	-	--	--	<b>\$22</b>
------------	----	---	----	----	-------------

Replacement key for bedside cabinets, dressers and wardrobes. Specify key number \_\_ - \_\_

ACCESSORIES

MODEL#

DIMENSIONS

FREIGHT CLASS

WT/LBS.

CUBIC FT.

LIST PRICE

D x W x H

For Aldon accessories, please refer to the models listed under Sonoma:

- Safety garment hook: page 32
- Headboards/footboards: page 32
- Memory box: page 33
- Mirrors: page 34
- Tackboard: page 34
- Whiteboard: page 34
- Wardrobe mirror (for door 11"W x 29"H): page 34



**Features and Benefits**

- Tops for units 37.5" or lower are constructed with 1" high pressure laminate
- Tops for units above 37.5" in height and structural fixed shelves are constructed of 1" thermally fused laminate
- Chassis, back panels, drawer fronts, adjustable shelves, doors and fascia profiles are constructed of 3/4" thermally fused laminate
- 3mm polymer edge with top over side panel design
- Constructed with NAUF (no added urea formaldehyde) particle board
- Laminate finishes are available in a variety of colors
- Thermofoil and Corian finishes are available on bedside cabinets. See notes for order requirements.
- All chassis panels and tops can be replaced if damaged
- Drawers are mounted on high quality precision steel full extension ball bearing slides
- Locks are optional on the top drawer position of all units
- Aluminum extrusions, legs and Plastic Parts are available in ten paint finishes
- Casters are available on bedside units
- Handles are offered in five styles
- Decorative fascia designs are available in four styles
- GREENGUARD INDOOR AIR QUALITY CERTIFICATION - in compliance with stringent emission guidelines set out by the Greenguard Environmental Institute under the standards for low emitting products and materials.  
[www.greenguard.org](http://www.greenguard.org).

Offers superior construction detail in an extensive selection of furniture pieces to fit the personal storage requirements of various lifestyle environments including Long Term Care, Retirement, Senior Living Residences and Hospitals.

Features distinctive Aluminum Extrusions on all leading corners allowing for a continuous connection of chassis panels from top to bottom providing enhanced performance and durability. The Aluminum Extrusions offer increased protection from the impact of mobile equipment and furniture used in demanding healthcare environments.

Products have ventilation and drainage features built into the unique design providing air circulation and drainage where required. Products are freestanding with under unit clearance for cleaning access.

Features decorative fascia options for enhancing the decor of any environment with the additional benefit of providing a safety guard to prevent items from falling behind units.

Wardrobe cabinets offer a Safety Garment Hook with a safety feature to support a maximum of 75 lbs. The Safety Coat Rail ensures maximum well being and peace of mind from accidents.

Multiple needs and requirements are met with the several styles and variety of interior configurations.

**ACCESSORIES**

- A complementary line of accessories is available to complete and enhance any room or setting.
- Bookcases offer the same superior construction utilizing aluminum extrusions on each corner and are available in several heights.
- A locking memory box is available with a glass front and three adjustable shelves allowing for personalized arrangement of possessions.
- Framed mirrors, whiteboard and tackboard options offer a bottom ledge and are available with the decorative fascia to complement room furniture.

**TOPS**

- Units of 37.5" or lower are constructed with 1" high pressure laminate with coordinating 3mm polymer edge.
- Units above 37.5" in height are constructed with 1" thermally fused laminate with coordinating 3mm polymer edge.
- Thermofoil and Corian finishes are available on bedside cabinets only. See page 22 for finishes.

**CHASSIS**

- Constructed from ¾" thermally fused laminate.
- Connected using aluminum extrusions allowing for a continuous connection top to bottom.
- Return on investment is enhanced through the ability to replace chassis panels or tops should they become damaged.

**BACK**

- Back panels are constructed from ¾" thermally fused laminate.

**DRAWERS**

- Drawer fronts are constructed of ¾" thermally fused laminate with 3mm PVC edge.
- Thermofoil finishes are available on bedside cabinets only.
- Mounted on high quality precision steel full extension ball bearing slides.
- Drawer depth is determined by the individual product size:  
20" deep cabinets feature 15.5" drawers.  
22" and 26" deep products feature 17.25" drawers.
- Bottom drawer interior is fully wrapped in a durable vinyl covering, neutral color (French Vanilla). This vinyl wrap offers superior durability and performance in demanding environments.
- Soft close drawer is optional, specify **(SF)** at time of order. Add **\$75** per drawer.

**DRAWER INSERTS**

- The optional bedside cabinet drawer liner insert and personal organizer tray sets are constructed of high impact styrene plastic in a neutral color (French Vanilla). See page 33 for purchase information.
- High impact styrene plastic liners have been specially designed to saddle the drawer edges for a perfect fit while eliminating gaps and potential traps.
- High impact styrene plastic insert liner and organizer tray set can be removed for ease of room transfer and cleaning.

**SHELVING**

- Structural fixed shelves are constructed of 1" thermally fused laminate with coordinating self edge.
- Adjustable shelves are constructed of ¾" thermally fused laminate with coordinating self edge.
- Shelf pins are offered for securing shelf with self drilling screws to prevent accidental movement.

**DOORS**

- Constructed of 0.75" thermally fused laminate with 3mm PVC edge.
- Mounted utilizing commercial quality hinges that provide a 170° opening span for easy access to personal belongings.

**SPILL COLLECTOR**

- Spill collector **(SC)** is optional on the edge of bedside cabinets with thermofoil finish only. Add **\$536**.  
Minimum order quantity of 3 pieces.
- **Note:** Bedside cabinets with spill collector will have no top fascia.

**LOCKS**

- A lock is optional on the top drawer position of all units with drawers. Must be specified at time of order.
- Random keying will be provided as standard when locks are ordered.
- For key alike numbering sequence, please specify keys number 401-440.
- For specifying lock on top drawer, indicate "**LS**" (lock set) after model number. Add **\$61** upcharge.
- Electronic lock **(EL)** available on select models. Add **\$385**.

**ALUMINUM EXTRUSIONS/LEGS/PLASTIC PARTS**

- Aluminum extrusions form the structural integrity of the product, ensuring a continuous solid connection for the unit chassis as well as providing leg support.
- The aluminum extrusion connection/leg is extended to allow clearance under each unit for access during cleaning.
- The aluminum extrusion connection/leg is standard with Charcoal color plastic glide and a non-marking leveler.
- Levelers offer 0.5" adjustment for increased stability and leveling.
- Standard powder coated paint finishes are Black **(BK)**, Latte **(LT)**, Charcoal **(CG)**, Kalua **(KL)**, Mocha **(MC)**, Nevada **(NV)**, Sierra **(SC)**, Silver **(SL)** and Taupe **(TP)**. Finish must be specified at time of order.
- Tungsten **(TN)** finish is available at a **10% upcharge**.
- Custom powder coated paint finishes are available. Please contact your customer care for further details.

**CASTERS**

- Available only on specific units.
- Products allowing use of casters are identified by the product code followed by a **(C)**.
- Casters must be specified at time of order.
- Casters cannot be retrofitted in the field.
- Casters are commercial quality, swivel dual wheel manual locking.

**HANDLES**

- Offered in six styles.
- Handles require a 128mm center point if custom styles are desired.
- Handle style must be specified at time of order.



**A1**  
Arc - Sierra



**B1**  
Bow - Matte Chrome

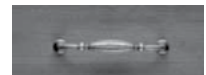

**B5**  
Bon-Bon - Burnished Brass



**CF**  
Curl - Pewter



**D3**  
Dome - Natural Iron



**RPH1** (add \$75/handle)  
Recessed - Silver

- Handles can be ordered separately (except for recessed handle). Add **\$29**. Please specify:  
**(GC-A1):** Arc - Sierra  
**(GC-B1):** Bow - Matte Chrome  
**(GC-B5):** Bon-Bon - Burnished Brass  
**(GC-CF):** Curl - Pewter  
**(GC-D3):** Dome - Natural Iron
- Recessed handle **(RPH1)** must be specified at time of order. Add **\$75/handle**.
- For additional finish options, please contact your Global sales representative.
- To view the Globalcare handle finish options, visit [globalfurnituregroup.com](http://globalfurnituregroup.com) and go to the Sonoma finishes section.

## POWER

- A power module (**PM01**) with one power outlet and one USB port can be installed on the fascia of bedside cabinets with laminated finish only. Add **\$290**.
- Fascia with a power module will be approximately 2" taller.



## DECORATIVE FASCIA OPTIONS

- Select from four fascia styles to create the room theme of your choice.
- Used to complement the decor and style of the room and are offered in the same laminate finish as the specified unit.
- Fascia profiles are constructed of ¾" thermally fused laminate, with all leading edges offering a coordinating self edge finish.
- Thermofoil finishes are available on bedside cabinets only.
- Fascia in Corian finish is available on bedside cabinets in linear (**LN**) style **only** and is 0.5" thick. The top fascia is factory-installed.
- Decorative fascia profiles are affixed to the top and bottom of each unit.
- Top fascia keeps items from falling off the back of the unit. The top fascia profile is installed on site.
- Fascia style must be specified at time of order.
- Top fascia cannot be specified with spill collector.

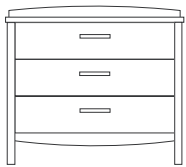

Arc (**AR**)

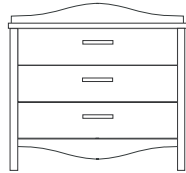

Wave (**WV**)



Scallop (**SL**)

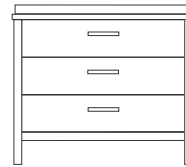

Linear (**LN**)

- Custom designed fascia options are available, please contact your Global sales representative.

## LAMINATE FINISHES - TOP AND CHASSIS

- All laminate finishes are available with coordinating 3mm polymer edge:
 

Absolute Acajou (ACJ)	Noce Biondo (NBL)
Asian Night (ASN)	Noce Grigio (NGL)
Avant Cherry (AWC)	Noce Leggero (NEL)
Avant Honey (AWH)	Noce Medio (NML)
Black (BLK)	Storm Grey (SOG)
Brushed Cobalt (BRC)	Tiger Fruitwood (TFW)
Clear Maple (CMB)	Tiger Walnut (TWL)
Dark Espresso (DES)	Walnut Heights (WHE)
Designer White (DWT)	White Chocolate (WHC)
Hayden Grey (HGT)	Winter Cherry (WCR)
Quartered Mahogany (QTM)	

## THERMOFOIL FINISHES - FRONT, TOP AND FASCIA

- Thermofoil finishes are available on bedside cabinets only. For pricing, please submit a Special Request Form to your Global representative.
- Extended lead times will apply.

## CORIAN FINISHES - TOP AND FASCIA

- Corian finishes are available on bedside cabinets only. See models ending in "**CO**" (Pricing shown for a minimum order quantity of 6 pieces. To order 5 pieces or less, please contact Customer Care for pricing).
 

Antarctica (ANT)	Linen (LIN)
Bisque (BIS)	Platinum (PLT)
Bone (BNE)	Savannah (SAV)
Cameo White (CWH)	Silver Grey (SGR)
Glacier White (GWH)	
- Extended lead times will apply.

## CUSTOM

- GLOBALcare invites the opportunity to provide quotation on special requests for project business.
- Please contact customer care.

## SHIPPING

- All products are shipped partially assembled, one per carton, unless otherwise noted.
- Fascia, shelves and accessories are to be installed on site.

**BEDSIDE CABINETS**

**Notes:** Please specify all substitutions and options.

- Bedside cabinets incorporate the unique aluminum extrusion connection/leg construction.
- The aluminum extrusion offers superior strength and durability from impact with mobile equipment and furniture used in the space.
- Ventilation openings have been strategically incorporated into each unit where needed.
- See Sonoma™ - Notes pages for details on tops, chassis, finish and detail selections.
- Must specify detail information at time of order. See Sonoma™ - Notes pages.
  1. Laminate finish
  2. Aluminum extrusion/leg paint finish
  3. Handle style and finish
  4. Fascia profile
- Drawer bottom is fully wrapped in almond colored vinyl
- An optional key lock is available for top drawer position only and must be specified at time of order.
- To specify lock on top drawer, indicate **(LS)** (lock set) after model number. Add **\$61**.
- For electronic lock, indicate **(EL)**. Add **\$385**. \*Not available on models with pull-out shelf.
- Casters are available as specified on models and cannot be retrofitted in the field.
- To add power module with one power outlet and one USB port on fascia (bedside cabinets with laminate finish only), specify **(PM01)**. Add **\$290**.

BEDSIDE CABINETS	MODEL#	DIMENSIONS D x W x H	FREIGHT CLASS	WT/LBS.	CUBIC FT.	LIST PRICE	MIN. QTY
------------------	--------	-------------------------	---------------	---------	-----------	------------	----------

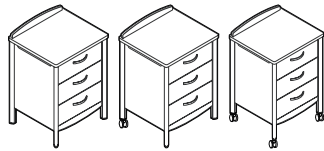

**Bedside Cabinet**

**No casters**

GCLBT01N	20.5 x 22.5 x 30	100	97	11	<b>\$1527</b>	
GCLBT01NCO					<b>\$3634</b>	6

w/Corian top

**Rear casters**

GCLBT01CN	20.5 x 22.5 x 30	100	100	11	<b>\$1607</b>	
GCLBT01CNCO					<b>\$3699</b>	6

w/Corian top

**Four casters**

GCLBT014CN	20.5 x 22.5 x 30	100	100	11	<b>\$1750</b>	
GCLBT014CNCO					<b>\$3772</b>	6

w/Corian top

Three drawers. Shipped partially assembled, 1 per carton.

- Model GCLBT01CN has two manual locking swivel casters on back.
- Model GCLBT014CN has four manual locking swivel casters.
- For Corian top, see models ending in "CO". Pricing shown for a minimum order quantity of 6 pieces. To order less than 6, please contact Customer Care for pricing. Extended lead times will apply.

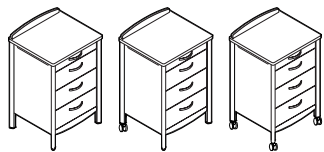

**Bedside Cabinet\***

**No casters**

GCLBT01SN	20.5 x 22.5 x 34.5	100	104	11	<b>\$1945</b>	
GCLBT01SNCO					<b>\$4003</b>	6

w/Corian top

**Rear casters**

GCLBT01CSN	20.5 x 22.5 x 34.5	100	107	11	<b>\$2014</b>	
GCLBT01CSNCO					<b>\$4063</b>	6

w/Corian top

**Four casters**

GCLBT014CSN	20.5 x 22.5 x 34.5	100	108	11	<b>\$2086</b>	
GCLBT014CSNCO					<b>\$4142</b>	6

w/Corian top

Three drawers and one pull-out shelf. Shipped partially assembled, 1 per carton.

- Model GCLBT01CSN has two manual locking swivel casters on back.
- Model GCLBT014CSN has four manual locking swivel casters.
- For Corian top, see models ending in "CO". Pricing shown for a minimum order quantity of 6 pieces. To order less than 6, please contact Customer Care for pricing. Extended lead times will apply.



BEDSIDE CABINETS

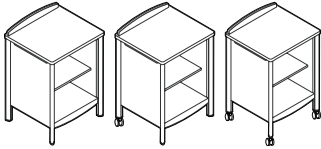

Bedside Cabinet

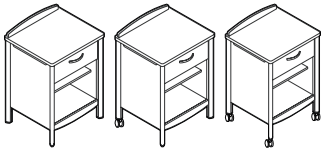

Bedside Cabinet

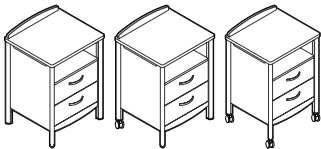

Bedside Cabinet

MODEL#	DIMENSIONS	FREIGHT CLASS	WT/LBS.	CUBIC FT.	LIST PRICE	MIN. QTY
<b>No casters</b>						
D x W x H						
GCLBT02N	20.5 x 22.5 x 30	150	58	11	\$886	
GCLBT02NCO					\$3106	6
w/Corian top						
<b>Rear casters</b>						
GCLBT02CN	20.5 x 22.5 x 30	150	60	11	\$947	
GCLBT02CNCO					\$3161	6
w/Corian top						
<b>Four casters</b>						
GCLBT024CN	20.5 x 22.5 x 30	150	60	11	\$1089	
GCLBT024CNCO					\$3217	6
w/Corian top						
One adjustable shelf. Shipped partially assembled, 1 per carton.						
<ul style="list-style-type: none"> <li>• Model GCLBT02CN has two manual locking swivel casters on back.</li> <li>• Model GCLBT024CN has four manual locking swivel casters.</li> <li>• For Corian top, see models ending in "CO". Pricing shown for a minimum order quantity of 6 pieces. To order less than 6, please contact Customer Care for pricing. Extended lead times will apply.</li> </ul>						
<b>No casters</b>						
GCLBT03N	20.5 x 22.5 x 30	125	76	11	\$1116	
GCLBT03NCO					\$3321	6
w/Corian top						
<b>Rear casters</b>						
GCLBT03CN	20.5 x 22.5 x 30	125	78	11	\$1189	
GCLBT03CNCO					\$3386	6
w/Corian top						
<b>Four casters</b>						
GCLBT034CN	20.5 x 22.5 x 30	125	78	11	\$1330	
GCLBT034CNCO					\$3415	6
w/Corian top						
One drawer, one adjustable shelf. Shipped partially assembled, 1 per carton.						
<ul style="list-style-type: none"> <li>• Model GCLBT03CN has two manual locking swivel casters on back.</li> <li>• Model GCLBT034CN has four manual locking swivel casters.</li> <li>• For Corian top, see models ending in "CO". Pricing shown for a minimum order quantity of 6 pieces. To order less than 6, please contact Customer Care for pricing. Extended lead times will apply.</li> </ul>						
<b>No casters</b>						
GCLBT04N	20.5 x 22.5 x 30	100	90	11	\$1365	
GCLBT04NCO					\$3480	6
w/Corian top						
<b>Rear casters</b>						
GCLBT04CN	20.5 x 22.5 x 30	100	92	11	\$1425	
GCLBT04CNCO					\$3547	6
w/Corian top						
<b>Four casters</b>						
GCLBT044CN	20.5 x 22.5 x 30	100	92	11	\$1569	
GCLBT044CNCO					\$3619	6
w/Corian top						
One fixed shelf, two drawers. Shipped partially assembled, 1 per carton.						
<ul style="list-style-type: none"> <li>• Model GCLBT04CN has two manual locking swivel casters on back.</li> <li>• Model GCLBT044CN has four manual locking swivel casters.</li> <li>• For Corian top, see models ending in "CO". Pricing shown for a minimum order quantity of 6 pieces. To order less than 6, please contact Customer Care for pricing. Extended lead times will apply.</li> </ul>						

## RETURNS

## MODEL# DIMENSIONS FREIGHT CLASS WT/LBS. CUBIC FT. LIST PRICE

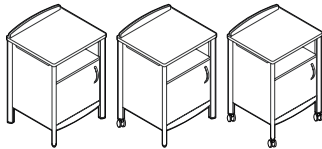

Bedside Cabinet

**No casters**

D x W x H

GCLBT05LN	20.5 x 22.5 x 30	125	74	11	<b>\$1164</b>	
GCLBT05LNCO					<b>\$3358</b>	6

**Rear casters**

GCLBT05CLN	20.5 x 22.5 x 30	125	77	11	<b>\$1224</b>	
GCLBT05CLNCO					<b>\$3415</b>	6

**Four casters**

GCLBT05L4CN	20.5 x 22.5 x 30	125	77	11	<b>\$1365</b>	
GCLBT05L4CNCO					<b>\$3448</b>	6

One fixed shelf, one **left** opening door with shelf. Shipped partially assembled, 1 per carton.

- Model GCLBT05CLN has two manual locking swivel casters on back.
- Model GCLBT05L4CN has four manual locking swivel casters.
- For Corian top, see models ending in "**CO**". Pricing shown for a minimum order quantity of 6 pieces. To order less than 6, please contact Customer Care for pricing. Extended lead times will apply.

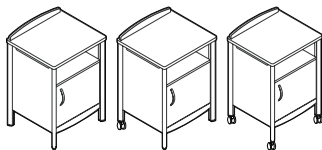

Bedside Cabinet

**No casters**

GCLBT05RN	20.5 x 22.5 x 30	125	74	11	<b>\$1164</b>	
GCLBT05RNCO					<b>\$3358</b>	6

**Rear casters**

GCLBT05CRN	20.5 x 22.5 x 30	125	77	11	<b>\$1224</b>	
GCLBT05CRNCO					<b>\$3415</b>	6

**Four casters**

GCLBT05R4CN	20.5 x 22.5 x 30	125	77	11	<b>\$1365</b>	
GCLBT05R4CNCO					<b>\$3448</b>	6

One fixed shelf, one **right** opening door with adjustable shelf. Shipped partially assembled, 1 per carton.

- Model GCLBT05CRN has two manual locking swivel casters on back.
- Model GCLBT05R4CN has four manual locking swivel casters.
- For Corian top, see models ending in "**CO**". Pricing shown for a minimum order quantity of 6 pieces. To order less than 6, please contact Customer Care for pricing. Extended lead times will apply.

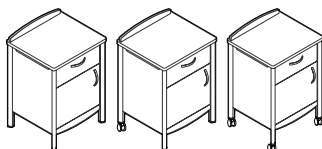

Bedside Cabinet

**No casters**

GCLBT06LN	20.5 x 22.5 x 30	125	82	11	<b>\$1391</b>	
GCLBT06LNCO					<b>\$3513</b>	6

**Rear casters**

GCLBT06CLN	20.5 x 22.5 x 30	125	84	11	<b>\$1459</b>	
GCLBT06CLNCO					<b>\$3575</b>	6

**Four casters**

GCLBT06L4CN	20.5 x 22.5 x 30	125	82	11	<b>\$1602</b>	
GCLBT06L4CNCO					<b>\$3650</b>	6

Top position drawer, one **LEFT** opening door with adjustable shelf.

- Model GCLBT06CLN has two manual locking swivel casters on back.
- Model GCLBT06L4CN has four manual locking swivel casters.
- For Corian top, see models ending in "**CO**". Pricing shown for a minimum order quantity of 6 pieces. To order less than 6, please contact Customer Care for pricing. Extended lead times will apply.

BEDSIDE CABINETS

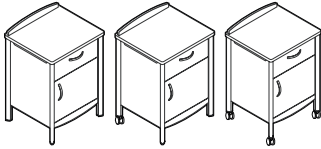

Bedside Cabinet

MODEL#	DIMENSIONS D x W x H	FREIGHT CLASS	WT/LBS.	CUBIC FT.	LIST PRICE	MIN. QTY
<b>No casters</b>						
GCLBT06RN	20.5 x 22.5 x 30	125	82	11	\$1391	
GCLBT06RNCO					\$3513	6
w/Corian top						
<b>Rear casters</b>						
GCLBT06CRN	20.5 x 22.5 x 30	125	84	11	\$1459	
GCLBT06CRNCO					\$3575	6
w/Corian top						
<b>Four casters</b>						
GCLBT06R4CN	20.5 x 22.5 x 30	125	84	11	\$1602	
GCLBT06R4CNCO					\$3650	6
w/Corian top						

Top position drawer, one **right** opening door with adjustable shelf. Shipped partially assembled, 1 per carton.

- Model GCLBT06CRN has two manual locking swivel casters on back.
- Model GCLBT06R4CN has four manual locking swivel casters.
- For Corian top, see models ending in "**CO**". Pricing shown for a minimum order quantity of 6 pieces. To order less than 6, please contact Customer Care for pricing. Extended lead times will apply.

DESKS, DRESSERS & HUTCHES

**Notes:** Please specify all substitutions and options.

- Desk, dresser and hutch units incorporate the unique aluminum extrusion connection/leg construction.
- The aluminum extrusion offers superior strength and durability from impact with mobile equipment and furniture used in the space.
- Ventilation openings have been strategically incorporated into each unit where needed.
- See Sonoma™ - Notes pages for details on tops, chassis, finish and detail selections.
- Must specify detail information at time of order. See Sonoma™ - Notes pages.
  1. Laminate finish
  2. Aluminum extrusion/leg paint finish
  3. Handle style and finish
  4. Fascia profile
- An optional key lock is available for top drawer position only and must be specified at time of order.
- To specify lock on top drawer, indicate "**LS**" (lock set) after model number. **Add \$61** list upcharge.

DESKS

MODEL#	DIMENSIONS	FREIGHT CLASS	WT/LBS.	CUBIC FT.	LIST PRICE
GCLDK01N	24 x 48 x 29	125	210	27	\$3360

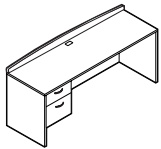

Single Pedestal Desk

Box/file pedestal on the **left**. Grommet in worksurface. Shipped partially assembled, 1 per carton.

GCLDK02N	24 x 48 x 29	70	105	6	\$1749
----------	--------------	----	-----	---	--------

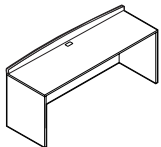

Desk Shell

Grommet in worksurface. Shipped partially assembled, 1 per carton.

## DRESSERS / HUTCHES

MODEL# DIMENSIONS FREIGHT CLASS WT/LBS. CUBIC FT. LIST PRICE

D x W x H

**26.5" Deep Dresser**

MODEL#	DIMENSIONS	FREIGHT CLASS	WT/LBS.	CUBIC FT.	LIST PRICE
GCLDR01N	26.5 x 34.5 x 30	125	152	22	<b>\$2045</b>

Three drawers. Shipped partially assembled, 1 per carton.

**22.5" Deep Dresser**

GCLDR02N	22.5 x 34.5 x 30	125	142	20	<b>\$1971</b>
----------	------------------	-----	-----	----	---------------

Three drawers. Shipped partially assembled, 1 per carton.

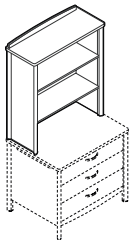
**Hutch For 30" High Dresser**

GCLDR03N	14.5 x 34.5 x 42	150	90	16	<b>\$1365</b>
----------	------------------	-----	----	----	---------------

Shelving unit for placement on 30" high dresser (overall height 72"). Hutch has one adjustable and one fixed shelf. Wire management grommet provides easy access for cables. Hutch utilizes the Aluminum Extrusion connection technology. For greater security, the Anti-Tip Security Kit is recommended on units above 60" (see page 31). Shipped partially assembled, 1 per carton.

**22.5" Deep Dresser**

GCLDR04N	22.5 x 34.5 x 37.5	125	174	24	<b>\$2478</b>
----------	--------------------	-----	-----	----	---------------

Four drawers. Shipped partially assembled, 1 per carton.

**26.5" Deep Dresser**

GCLDR05N	26.5 x 34.5 x 37.5	125	178	27	<b>\$2343</b>
----------	--------------------	-----	-----	----	---------------

Three drawers with open storage space above. Cord access in back. Shipped partially assembled, 1 per carton.

**22" Deep Dresser**

GCLDR06N	22.5 x 34.5 x 37.5	125	166	24	<b>\$2249</b>
----------	--------------------	-----	-----	----	---------------

Three drawers with open storage space above. Cord access in back. Shipped partially assembled, 1 per carton.

**DRESSERS / HUTCHES**



**26.5" Deep Dresser**

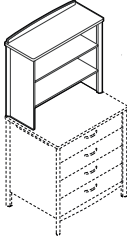

**Hutch For 37.5" High Dresser**



**Double Dresser**

MODEL#	DIMENSIONS D x W x H	FREIGHT CLASS	WT/LBS.	CUBIC FT.	LIST PRICE
GCLDR07N	26.5 x 34.5 x 37.5	125	186	27	<b>\$2550</b>

Four drawers. Shipped partially assembled, 1 per carton.

GCLDR08N	14.5 x 34.5 x 34.5	150	83	15	<b>\$1189</b>
----------	--------------------	-----	----	----	---------------

Shelving unit for placement on 37.5" high dresser (overall height 72"). Hutch has one adjustable and one fixed shelf. Wire management grommet provides easy access for cables. Hutch utilizes the aluminum extrusion connection technology. For greater security, the Anti-Tip Security Kit is recommended on units above 60" (see page 31). Shipped partially assembled, 1 per carton.

GCLDD01N	26.5 x 66.5 x 30	125	283	40	<b>\$4620</b>
----------	------------------	-----	-----	----	---------------

Double dresser with three drawers. 26" deep at each side.

**WARDROBE CABINETS**

**Notes:** Please specify all substitutions and options.

- Wardrobe cabinets incorporate the unique aluminum extrusion connection/leg construction.
- The aluminum extrusion offers superior strength and durability from impact with mobile equipment and furniture used in the space.
- Doors are mounted utilizing commercial quality hinges that provide a 170° opening span for comfortable access to personal belongings.
- Ventilation and draining have been strategically incorporated into each unit where needed.
- Wardrobe cabinets offer a safety garment hook as standard and a J-style safety clothing rail to ensure maximum well being and peace of mind from accidents.
- See Sonoma™ - Notes pages for details on tops, chassis, finish and detail selections.
- Must specify detail information at time of order. See Sonoma™ - Notes pages.
  1. Laminate finish
  2. Aluminum extrusion/leg paint finish
  3. Handle style and finish
  4. Fascia profile
- Optional door lock is available. Must be quoted on a project opportunity as a special.
- See accessories for additional options to enhance personal storage features.

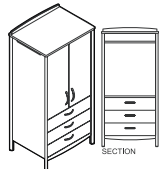

**Storage Wardrobe Cabinet, Hinged Doors**

GCLWA01N	26.5 x 34.5 x 72	150	274	55	<b>\$4344</b>
----------	------------------	-----	-----	----	---------------

Inside dimensions:

- Top shelf: 30.75"W x 19.5"D
- Clothing rail area: 30.75"W x 19.5"D x 34"H
- Drawers: 28"W x 5.125"D x 17"H

72" high combination unit with 170° hinged doors and 3 drawers. Inside configuration has a J-style safety clothing rail. For greater security, the Anti-Tip Security Kit is recommended on units above 60" (see page 31). Lock not available on door. Shipped partially assembled, 1 per carton.

## WARDROBE CABINETS

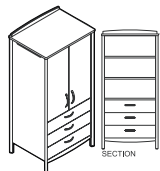

**Storage Wardrobe Cabinet,  
Hinged Doors**

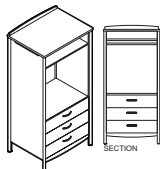

**Open Wardrobe Cabinet**

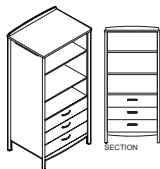

**Open Wardrobe Cabinet**

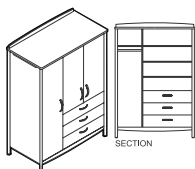

**Wardrobe Cabinet**

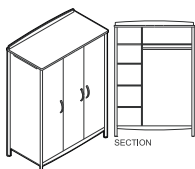

**Wardrobe Cabinet**

MODEL#	DIMENSIONS D x W x H	FREIGHT CLASS	WT/LBS.	CUBIC FT.	LIST PRICE
--------	-------------------------	---------------	---------	-----------	------------

GCLWA02N	26.5 x 36.5 x 72	150	312	55	<b>\$4620</b>
----------	------------------	-----	-----	----	---------------

Inside dimensions:

- Top section with adjustable shelves: 30.75"W x 22.75"D x 41"H
- Drawers: 28"W x 5.125"D x 17"H

72" high combination unit with 170° hinged doors and 3 drawers. Inside configuration has two adjustable shelves. For greater security, the Anti-Tip Security Kit is recommended on units above 60" (see page 31). Lock not available on door. Shipped partially assembled, 1 per carton.

GCLWA03N	26.5 x 34.5 x 72	150	300	55	<b>\$3641</b>
----------	------------------	-----	-----	----	---------------

Inside dimensions:

- Top shelf: 30.75"W x 22.75"D
- Drawers: 28"W x 5.125"D x 17"H

Open front wardrobe with J-style safety clothing rail and three full drawers below. J-style safety clothing rail below a fixed shelf. Three exposed drawers below. For greater security, the Anti-Tip Security Kit is recommended on units above 60" (see page 31). Shipped partially assembled, 1 per carton.

GCLWA04N	26.5 x 34.5 x 72	60	300	5.45	<b>\$3918</b>
----------	------------------	----	-----	------	---------------

Inside dimensions:

- Top section with adjustable shelves: 30.75"W x 22.75"D x 41"H
- Drawers: 28"W x 5.125"D x 17"H

Open front wardrobe with J-style safety clothing rail and two adjustable shelves and three full drawers below. For greater security, the Anti-Tip Security Kit is recommended on units above 60" (see page 31). Shipped partially assembled, 1 per carton.

GCLWC01N	26.5 x 50.5 x 72	125	444	71	<b>\$5402</b>
----------	------------------	-----	-----	----	---------------

Inside dimensions:

- Left side top shelf: 14.75"W x 20.75"D x 8.625"H
- Left side clothing rail area: 14.75"W x 20.75"D x 55.6"H
- Right side top shelf: 30.75"W x 20.75"D x 8.625"H
- Right side middle section with adjustable shelf: 30.75"W x 20.75"D x 32"H
- Right side bottom section: 30.75"W x 20.75"D x 24"H
- Drawers: 28.5"W x 5.125"D x 17.25"H

Three doors. Interior **left** side offers an upper shelf with a J-style safety clothing rail below. The **right** side of the cabinet has two half length doors with two fixed and two adjustable shelves. Three drawers below. A safety garment hook is standard on the cabinet interior door. For greater security, the Anti-Tip Security Kit is recommended on units above 60" (see page 31). Shipped partially assembled, 1 per carton.

GCLWC02N	26.5 x 50.5 x 72	125	430	71	<b>\$4869</b>
----------	------------------	-----	-----	----	---------------

Inside dimensions:

- Left side top shelf: 14.75"W x 20.75"D x 8.625"H
- Left side middle section with adjustable shelf: 14.75"W x 20.75"D x 38.7"H
- Left side bottom section: 14.75"W x 20.75"D x 15.8"H
- Right side top shelf: 30.75"W x 20.75"D x 8.625"H
- Right side clothing rail area: 30.75"W x 22.75"D x 55.6"H

Three full length doors. Interior **left** side offers two adjustable and two fixed shelves. Interior **right** side offers an upper shelf with a J-style safety clothing rail below. A Safety Garment Hook is standard on the cabinet interior door. For greater security, the Anti-Tip Security Kit is recommended on units above 60" (see page 31). Shipped partially assembled, 1 per carton.

## WARDROBE CABINETS

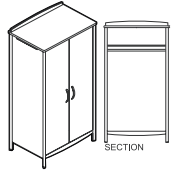

Wardrobe Cabinet

MODEL#	DIMENSIONS D x W x H	FREIGHT CLASS	WT/LBS.	CUBIC FT.	LIST PRICE
GCLWD01N	26.5 x 38.5 x 72	150	262	55	<b>\$3400</b>

Inside dimensions:

- Top shelf: 34.75"W x 22.7"D x 8.625"H
- Bottom portion: 34.75"W x 22.7"D x 50.6"H

Two doors, full span J-style safety clothing rail below a fixed shelf. A safety garment hook is standard on the cabinet interior door. For greater security, the Anti-Tip Security Kit is recommended on units above 60" (see page 31). Lock not available on door. Shipped partially assembled, 1 per carton.

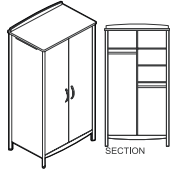

Wardrobe Cabinet

GCLWD02N	26.5 x 38.5 x 72	150	283	55	<b>\$3905</b>
----------	------------------	-----	-----	----	---------------

Inside dimensions:

- Left side top shelf: 17"W x 20.7"D x 8.625"H
- Left side clothing rail area: 17"W x 20.7"D x 55.6"H
- Right side top shelf: 17"W x 20.7"D x 8.625"H
- Right side clothing rail area: 17"W x 20.7"D x 36.6"H

Two doors. Interior is divided in two with an upper shelf and a J-style safety clothing rail on the **left** side. The **right** side has one adjustable and two fixed shelves with a J-style safety clothing rail below. A safety garment hook is standard on the cabinet interior door. For greater security, the Anti-Tip Security Kit is recommended on units above 60" (see page 31). Shipped partially assembled, 1 per carton.

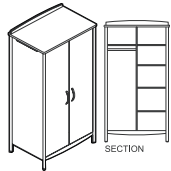

Wardrobe Cabinet

GCLWD03N	26.5 x 38.5 x 72	150	298	55	<b>\$4195</b>
----------	------------------	-----	-----	----	---------------

Inside dimensions:

- Left side top shelf: 17"W x 20.7"D x 8.625"H
- Left side clothing rail area: 17"W x 20.7"D x 55.6"H
- Right side top shelf: 17"W x 20.7"D x 8.625"H
- Right side middle section with adjustable shelf: 17"W x 20.7"D x 38.7"H
- Right side bottom section: 17"W x 20.7"D x 15.8"H

Two doors. Interior is divided in two with an upper shelf and a J-style safety clothing rail on the **left** side. The **right** side has two adjustable and two fixed shelves. A safety garment hook is standard on the cabinet interior door. For greater security, the Anti-Tip Security Kit is recommended on units above 60" (see page 31). Shipped partially assembled, 1 per carton.

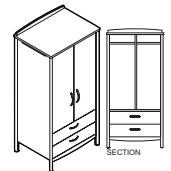

Divided Wardrobe Cabinet

GCLWG01N	26.5 x 34.5 x 72	150	294	55	<b>\$4061</b>
----------	------------------	-----	-----	----	---------------

Inside dimensions:

- Left side top shelf: 15"W x 19.5"D x 8.625"H
- Left side clothing rail area: 15"W x 19.5"D x 48.5"H
- Top drawer: 28"W x 5.125"D x 17"H
- Right side top shelf: 15"W x 19.5"D x 8.625"H
- Right side clothing rail area: 15"W x 19.5"D x 48.5"H
- Lower drawer: 28"W x 5.125"D x 17"H

Two doors covering interior divided in two with upper shelf and J-style safety clothing rail on both right and left sides. Two exposed drawers below. A safety garment hook is standard on the cabinet interior door. For greater security, the Anti-Tip Security Kit is recommended on units above 60" (see page 31). Shipped partially assembled, 1 per carton.

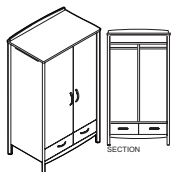

Divided Wardrobe Cabinet

GCLWG02N	26.5 x 41.75 x 72	150	312	66	<b>\$4485</b>
----------	-------------------	-----	-----	----	---------------

Inside dimensions:

- Left side top shelf: 18.7"W x 19.5"D x 8.625"H
- Left side clothing rail area: 18.7"W x 19.5"D x 49.25"H
- Left drawer: 16.5"W x 5.125"D x 15.5"H
- Right side top shelf: 18.7"W x 19.5"D x 8.625"H
- Right side clothing rail area: 18.7"W x 19.5"D x 49.25"H
- Right drawer: 16.5"W x 5.125"D x 15.5"H

Two doors covering interior divided in two with upper shelf and J-style safety clothing rail on both right and left sides. One exposed drawer on each right and left side below. A safety garment hook is standard on the cabinet interior door. For greater security, the Anti-Tip Security Kit is recommended on units above 60" (see page 31). Shipped partially assembled, 1 per carton.

## RETURNS

MODEL# DIMENSIONS FREIGHT CLASS WT/LBS. CUBIC FT. LIST PRICE

D x W x H

**Left:**GCLWN01LN 24.5 x 22.5 x 72 125 216 30 **\$3218****Right:**GCLWN01RN 24.5 x 22.5 x 72 125 216 30 **\$3218**

Inside dimensions:

- Top shelf: 18.7"W x 20.7"D
- Top drawer: 16.5"W x 5.125"D x 15.5"H
- Clothing rail area: 18.7"W
- Lower drawer: 16.5"W x 5.125"D x 15.5"H

One door covering upper shelf and J-style safety clothing rail. Two exposed drawers below. For greater security, the Anti-Tip Security Kit is recommended on units above 60" (see page 31). Shipped partially assembled, 1 per carton.

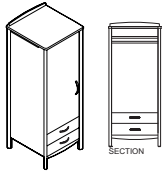
**Narrow Wardrobe Cabinet****Left:**GCLWN02LN 24.5 x 22.5 x 72 150 274 55 **\$2732****Right:**GCLWN02RN 24.5 x 22.5 x 72 150 274 55 **\$2732**

Inside dimensions:

- Top section with adjustable shelves: 18.25"W x 22.25"D x 29.5"H
- Bottom section: 18.25"W x 22.25"D x 34.8"H

One door covering interior with two adjustable shelves, a fixed shelf and J-style safety clothing rail. For greater security, the Anti-Tip Security Kit is recommended on units above 60" (see page 31). Shipped partially assembled, 1 per carton.

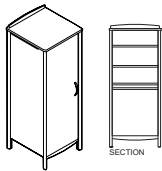
**Narrow Wardrobe Cabinet**V00465FLOCK3/4 -- x -- x -- - -- .01 **\$56**

Replacement core and key.

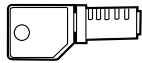
**Replacement Lock Set**WL2EK -- x -- x -- - -- .01 **\$22**

Replacement key for all units with drawers. Specify key number 401-440.

**Replacement Key**

## ACCESSORIES

MODEL# DIMENSIONS FREIGHT CLASS WT/LBS. CUBIC FT. LIST PRICE

**Notes:** Please specify all substitutions and options.

- Bookcase units incorporate the unique aluminum extrusion connection/leg construction.
- The aluminum extrusion offers superior strength and durability from impact with mobile equipment and furniture used in the space.
- See Sonoma™ - Notes pages for details on tops, chassis, finish and detail selections.
- Must specify detail information at time of order. See Sonoma™ - Notes pages.
  1. Laminate finish
  2. Aluminum extrusion/leg paint finish
  3. Fascia profile

## ACCESSORIES

MODEL# DIMENSIONS FREIGHT CLASS WT/LBS. CUBIC FT. LIST PRICE

GCAT400 -- 70 0.24 0.1 **\$113****Anti-Tip Security Kit**

Helps to prevent furniture from tipping over. This cabinet stabilization hardware is made from steel and galvanized steel aircraft cable. Full installation instructions are included. Recommended for all 72" high units.

- Two kits are required for LWA, LWC, LWD, LWG and LWN units.



ACCESSORIES

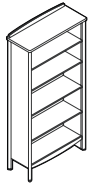

Bookcase

MODEL#	DIMENSIONS D x W x H	FREIGHT CLASS	WT/LBS.	CUBIC FT.	LIST PRICE
GCLBC01N	14.5 x 34.5 x 72	150	143	29	\$2045

72" high. 3 adjustable shelves and 1 fixed. For greater security, the Anti-Tip Security Kit is recommended on units above 60" (see page 31). Shipped partially assembled, 1 per carton.

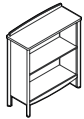

Bookcase

GCLBC02N	14.5 x 34.5 x 37.5	150	76	16	\$1527
----------	--------------------	-----	----	----	--------

37.5" High. 1 adjustable shelf. Shipped partially assembled, 1 per carton.

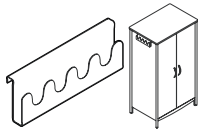

Multiple Hook

GCLHA01	2 x 13 x 4.25	70	1	0.2	\$117
---------	---------------	----	---	-----	-------

Fits into ventilation opening of Wardrobes providing additional hanging of frequently worn or accessed items.  
 • Standard Powder Coated Paint Finish Color: Sierra (SC).

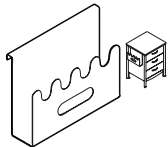

Magazine/Tissue Holder

GCLHA02	3.75 x 13 x 10	70	1.5	0.6	\$193
---------	----------------	----	-----	-----	-------

Fits into ventilation opening of Bedside Cabinet or Dresser providing convenient storage and hanging of frequently accessed items.  
 • Standard Powder Coated Paint Finish Color: Sierra (SC).



Safety Garment Hook

GCLHA03	1 x 1.5 x 3.25	70	1.5	0.2	\$33
---------	----------------	----	-----	-----	------

Garment hook provides additional hanging storage on the inside **right** and **center** wardrobe doors as standard. Engineered with the safety feature to support a maximum weight of 75 lbs.  
 • Standard Powder Coated Paint Finish Color: Sierra (SC).

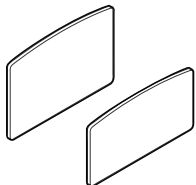

Headboard and Footboard Fascia Profile: Arc (AR)



GCLHF01 Set	1 x 37 x 25	65	47	1.9	\$1189
-------------	-------------	----	----	-----	--------

GCLHB01 Headboard	1 x 37 x 25	85	26	1.9	\$866
-------------------	-------------	----	----	-----	-------

GCLFB01 Footboard	1 x 37 x 20	85	21	1.7	\$388
-------------------	-------------	----	----	-----	-------

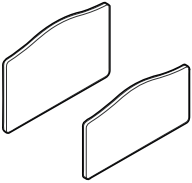
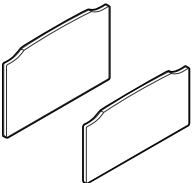
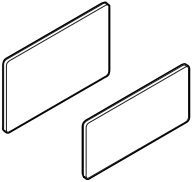
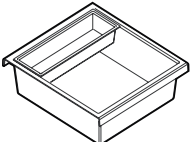
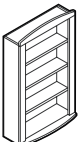
Headboard and footboard are provided as a set or can be ordered individually. 1" thick high pressure laminate with 3mm edge.  
 • No predrilled holes.  
 • No mounting brackets or hardware included.  
 • *Verify board application and dimensions before ordering.*

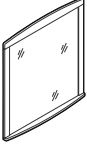
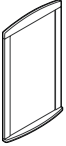
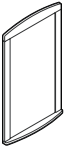
ACCESSORIES	MODEL#	DIMENSIONS D x W x H	FREIGHT CLASS	WT./LBS.	CUBIC FT.	LIST PRICE
 <p><b>Headboard and Footboard Fascia Profile: Wave (WV)</b></p>	GCLHF02 Set		65	47	1.9	<b>\$1189</b>
	GCLHB02 Headboard	1 x 37 x 25	85	26	1.9	<b>\$866</b>
	GCLFB02 Footboard	1 x 37 x 20	85	21	1.7	<b>\$388</b>
<p>Headboard and footboard are provided as a set or can be ordered individually. 1" thick high pressure laminate with 3mm edge.</p> <ul style="list-style-type: none"> <li>• No predrilled holes.</li> <li>• No mounting brackets or hardware included.</li> <li>• <i>Verify board application and dimensions before ordering.</i></li> </ul>						
 <p><b>Headboard and Footboard Fascia Profile: Scallop (SL)</b></p>	GCLHF03 Set	1 x 37 x 25	65	47	1.9	<b>\$1189</b>
	GCLHB03 Headboard	1 x 37 x 25	85	26	1.9	<b>\$866</b>
	GCLFB03 Footboard	1 x 37 x 20	85	21	1.7	<b>\$388</b>
<p>Headboard and footboard are provided as a set or can be ordered individually. 1" thick high pressure laminate with 3mm edge.</p> <ul style="list-style-type: none"> <li>• No predrilled holes.</li> <li>• No mounting brackets or hardware included.</li> <li>• <i>Verify board application and dimensions before ordering.</i></li> </ul>						
 <p><b>Headboard and Footboard Fascia Profile: Linear (LN)</b></p>	GCLHF04 Set	1 x 37 x 25	65	47	1.9	<b>\$1189</b>
	GCLHB04 Headboard	1 x 37 x 25	85	26	1.9	<b>\$866</b>
	GCLFB04 Footboard	1 x 37 x 20	85	21	1.7	<b>\$388</b>
<p>Headboard and footboard are provided as a set or can be ordered individually. 1" thick high pressure laminate with 3mm edge.</p> <ul style="list-style-type: none"> <li>• No predrilled holes.</li> <li>• No mounting brackets or hardware included.</li> <li>• <i>Verify board application and dimensions before ordering.</i></li> </ul>						
 <p><b>Bedside Drawer Liner and Personal Organizer</b></p>	GCLLP01	16.5 x 18 x 5.25	60	2	0.01	<b>\$205</b>
<p>Constructed from high impact styrene plastic. Plastic liners have been specially designed to saddle the drawer edges for a perfect fit while eliminating gaps and potential traps. Removable.</p> <ul style="list-style-type: none"> <li>• Neutral color (French Vanilla) coordinates with drawer interiors.</li> </ul>						
 <p><b>Wall Mount Memory Box</b></p>	Left opening: GCLMB01LN	6 x 21 x 35	85	55	4.3	<b>\$1189</b>
	Right opening: GCLMB01RN	6 x 21 x 35	85	55	4.3	<b>\$1189</b>
	<p>3 adjustable shelves. Left/right opening tempered glass door framed in laminate finish. Lock is standard. Installation brackets are heavy duty extruded aluminum and include a level and hardware. Shipped partially assembled, 1 per carton.</p>					

ACCESSORIES	MODEL#	DIMENSIONS	FREIGHT CLASS	WT/LBS.	CUBIC FT.	LIST PRICE
 <p><b>Mirror 21" Wide</b></p>		<b>D x W x H</b>				
	GCLMR01N	2 x 21 x 35	70	29	1.50	<b>\$953</b>
<p>Framed in laminate finish, includes a bottom ledge. Mirror is backed in shatterproof safety tape, tested for shatter resistance. Installation brackets are heavy duty extruded aluminum and include a level and hardware. 1 per carton.</p>						
 <p><b>Mirror 33" Wide</b></p>						
	GCLMR02N	2 x 33 x 35	85	29	2.12	<b>\$1330</b>
<p>Framed in laminate finish, includes a bottom ledge. Mirror is backed in shatterproof safety tape, tested for shatter resistance. Installation brackets are heavy duty extruded aluminum and include a level and hardware. 1 per carton.</p>						
 <p><b>Tackboard 21"</b></p>						
	GCLTB01N	2 x 21 x 35	100	12	1.50	<b>\$651</b>
<p>Tackable surface is <b>(2162)</b> Forbo. Framed in laminate finish, includes a 1" bottom ledge. Installation brackets are heavy duty extruded aluminum and include a level and hardware. 1 per carton.</p>						
 <p><b>Whiteboard 21"</b></p>						
	GCLWB01N	2 x 21 x 35	85	20	1.50	<b>\$603</b>
<p>Framed in laminate finish, includes a bottom ledge. Installation brackets are heavy duty extruded aluminum and include a level and hardware. 1 per carton.</p>						
 <p><b>Wardrobe Mirror</b></p>						
	GCLWM01	0.25 x 11 x 29	60	5	.05	<b>\$247</b>
<p>Installed on the <b>left</b> inside of the door. Backed with shatterproof safety tape, tested for shatter resistance. Double mounted with both rubber lined mirror clips and heavy duty foam tape. Edges are polished. 1 per carton.</p>						

cafeteria + dining + occasional + reception

# tables

MODEL#	DIMENSIONS D x W x H	FREIGHT CLASS	WT/LBS.	CUBIC FT.	LIST PRICE
--------	-------------------------	---------------	---------	-----------	------------

- Notes:**
- 1.75" tubular steel frame available in Black (**BLK**), Shadow (**SHW**), Toast (**TOA**), Tungsten (**TUN**), Latte (**LAB**), Mocha (**J52**), and Kalua (**KAL**). Please specify leg finish color when placing order.
  - Frame can be weighted and made with tamperproof fasteners
  - Tables are 16" high
  - Please specify all substitutions and options.
  - 1" thick tops are available in thermally fused laminate (L) and high pressure laminate (H). Please select the appropriate model number for the finish you prefer.
  - 3mm edging color coordinated with laminate finish is standard for all tops. Finish **MUST BE** specified at the time of order.
  - Refer to the following lists when selecting a finish color. **MUST** Specify both a Top Color and Leg Finish when ordering.
  - For custom laminate or contrasting edge, please contact your Global sales representative for special quotation.

**Thermally Fused Laminate (LP)**

- Absolute Acajou (ACJ)
- Asian Night (ASN)
- Avant Cherry (AWC)
- Avant Honey (AWH)
- Black (BLK)
- Brushed Cobalt (BRC)
- Clear Maple (CMB)
- Dark Espresso (DES)
- Designer White (DWT)
- Hayden Grey (HGT)
- Noce Biondo (NBL)
- Noce Grigio (NGL)
- Noce Leggero (NEL)
- Noce Medio (NML)
- Quartered Mahogany (QTM)
- Storm Grey (SOG)
- Tiger Fruitwood (TFW)
- Tiger Walnut (TWL)
- Walnut Heights (WHE)
- White Chocolate (WHC)
- Winter Cherry (WCR)

**High Pressure Laminate (HP)**

- Absolute Acajou (ACJ)
- Asian Night (ASN)
- Avant Cherry (W357)
- Avant Honey (W356)
- Black (BLK)
- Brushed Cobalt (BRC)
- Clear Maple (CMB)
- Dark Espresso (W142)
- Designer White (DWT)
- Hayden Grey (HGT)
- Noce Biondo (NBL)
- Noce Grigio (NGL)
- Noce Leggero (NEL)
- Noce Medio (NML)
- Quartered Mahogany (QTM)
- Storm Grey (SOG)
- Tiger Fruitwood (TFW)
- Tiger Walnut (W819)
- Walnut Heights (WHE)
- White Chocolate (WHC)
- Winter Cherry (WCR)

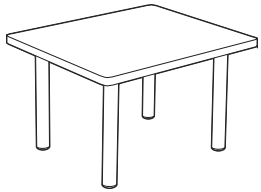
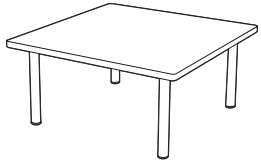
	MODEL#	DIMENSIONS	FREIGHT CLASS	WT/LBS.	CUBIC FT.	LIST PRICE
 <p><b>Rectangular End Table</b></p>	GC4191-LP	22 x 26 x 16	100	25	3.1	<b>\$820</b>
	GC4191-HP	22 x 26 x 16	100	25	3.1	<b>\$936</b>
<ul style="list-style-type: none"> <li>• For a thermally fused laminate top (LP), specify model GC4191-LP</li> <li>• For a high pressure laminate top (HP), specify model GC4191-HP.</li> </ul> <p>1" thick top with coordinating 3mm edge and 1 3/4" dia. steel tubular legs</p>						
 <p><b>Corner Table Square</b></p>	GC4192-LP	34 x 34 x 16	125	46	6	<b>\$1007</b>
	GC4192-HP	34 x 34 x 16	125	46	6	<b>\$1205</b>
<ul style="list-style-type: none"> <li>• For a thermally fused laminate top (LP), specify model GC4192-LP.</li> <li>• For a high pressure laminate top (HP), specify model GC4192-HP.</li> </ul> <p>1" thick top with coordinating 3mm edge and 1 3/4" dia. steel tubular legs</p>						

MODEL#	DIMENSIONS	FREIGHT CLASS	WT/LBS.	CUBIC FT.	LIST PRICE
--------	------------	---------------	---------	-----------	------------

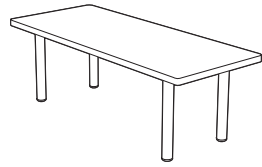

**Coffee Table Rectangular**

	D x W x H				
GC4193-LP	20 x 48 x 16	125	37	5.75	<b>\$955</b>
GC4193-HP	20 x 48 x 16	125	37	5.75	<b>\$1138</b>

- For a thermally fused laminate top (LP), specify model GC4193-LP.
- For a high pressure laminate top (HP), specify model GC4193-HP.

1" thick top with coordinating 3mm edge and 1 3/4" dia. steel tubular legs

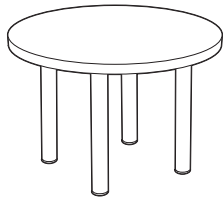

**24" Round Table**

GC4194-LP	24 x 24 x 16	125	25	3.4	<b>\$796</b>
GC4194-HP	24 x 24 x 16	125	25	3.4	<b>\$869</b>

- For a thermally fused laminate top (LP), specify model GC4194-LP.
- For a high pressure laminate top (HP), specify model GC4194-HP.

1" thick top with coordinating 3mm edge and 1 3/4" dia. steel tubular legs

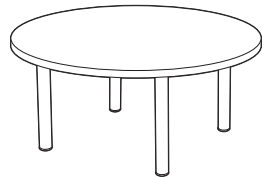

**36" Round Table**

GC4195-LP	36 x 36 x 16	125	42	6	<b>\$971</b>
GC4195-HP	36 x 36 x 16	125	42	6	<b>\$1047</b>

- For a thermally fused laminate top (LP), specify model GC4194-LP.
- For a high pressure laminate top (HP), specify model GC4194-HP.

1" thick top with coordinating 3mm edge and 1 3/4" dia. steel tubular legs

MODEL#	DIMENSIONS	FREIGHT CLASS	WT/LBS.	CUBIC FT.	LIST PRICE
--------	------------	---------------	---------	-----------	------------

D x W x H

**Notes:** Please specify all substitutions and options.

- Offers a solution to users with limited mobility.
- The Enable table top allows for two fixed tablets and two height adjustable tablets to be installed on opposite side into pre-drilled holes with metal inserts on the underside of the top
- The fixed and/or height adjustable tablets can be added to the table surface as needed to accommodate change in a person's physical abilities for continued enjoyment during mealtime and activities.
- Height adjustable tablet surface has a 13.5" range of motion (supporting heights from 22.5" to 36") for addressing mobility issues and devices (wheelchairs, geriatric chairs, walkers).
- Heavy duty tapered steel legs are available in Black (**BLK**), Shadow (**SHW**), Storm Grey (**SOG**), Toast (**TOA**) and Tungsten (**TUN**). Finish must be specified at the time of order.
- Legs are available with Black (**BLK**) plastic glides offering 1.5" adjustment as standard, except Tungsten (**TUN**) which has Tungsten glides.
- Shipped easy to assemble.
- 2mm edging color coordinated with laminate finish is standard for all tops. Finish must be specified at time of order.
- Tops are 1" thick and available in thermally fused laminate (**LP**) and high pressure laminate (**HP**). Please select the appropriate model number for the finish you prefer.
- Additional weight is available for added safety. Specify (**NC**) for no additional weight, (**13**) for 13 lbs. or (**26**) for 26 lbs. weights. For (**13**), add **\$352**. For (**26**), add **\$553**.
- Refer to the following lists when selecting a finish color. Must specify both a top color and leg finish at time of order.
- For custom laminate or contrasting edge, please contact your Global sales representative for special quotation.

**Thermally Fused (LP) and High Pressure (HP) Laminate Finishes:**

- |                          |                       |
|--------------------------|-----------------------|
| Absolute Acajou (ACJ)    | Asian Night (ASN)     |
| Avant Cherry (AWC)       | Avant Honey (AWH)     |
| Black (BLK)              | Brushed Cobalt (BRC)  |
| Clear Maple (CMB)        | Dark Espresso (DES)   |
| Designer White (DWT)     | Hayden Grey (HGT)     |
| Noce Biondo (NBL)        | Noce Grigio (NGL)     |
| Noce Leggero (NEL)       | Noce Medio (NML)      |
| Quartered Mahogany (QTM) | Storm Grey (SOG)      |
| Tiger Fruitwood (TFW)    | Tiger Walnut (TWL)    |
| Walnut Heights (WHE)     | White Chocolate (WHC) |
| Winter Cherry (WCR)      |                       |



TABLES	MODEL#	DIMENSIONS	FREIGHT CLASS	WT/LBS.	CUBIC FT.	LIST PRICE
--------	--------	------------	---------------	---------	-----------	------------

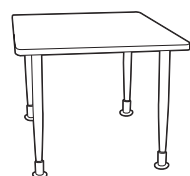

**Table Top with Legs**



**E-Z Lift Dual Arm Tablet**

Thermally fused:						
GCEN3642L	42 x 36 x 29	70	89	5.7		<b>\$1906</b>
GCEN4242L	42 x 42 x 29	70	102	6		<b>\$2071</b>
GCEN4848L	48 x 48 x 29	70	121	6.6		<b>\$2383</b>

High pressure:						
GCEN3642H	42 x 36 x 29	70	89	5.7		<b>\$2402</b>
GCEN4242H	42 x 42 x 29	70	102	6		<b>\$2570</b>
GCEN4848H	48 x 48 x 29	70	121	6.6		<b>\$2884</b>

Allows for two EZ-lift arm tablets to be installed on the 42" or 48" wide ends and two fixed arm tablets on the 36" sides. 2 cartons

Thermally fused:						
GC3-DALN	13 x 36 x 7	125	31	4.9		<b>\$1639</b>
High pressure:						
GC3-DAHN	13 x 36 x 7	125	31	4.9		<b>\$2007</b>

Adjusts up or down by the use of a single paddle actuator. Tablet remains level during adjustment and has a positive locking, smooth counterbalanced operation through the use of a gas cylinder. Tablet range of adjustment is 22.5"H to 36"H from the floor. Guard at the back prevents items from falling. 2 cartons.

- Allowance between arms is 21" for use with wheelchairs.
- Each tablet adds 15" to the depth of the table.
- Fits pre-drilled inserts on 42" or 48" table sides only. Hardware for attaching to table top is included.
- Mechanism and tablet bracket are available in Black only.

MODEL#	DIMENSIONS	FREIGHT CLASS	WT/LBS.	CUBIC FT.	LIST PRICE
--------	------------	---------------	---------	-----------	------------



Fixed Height Tablet



Tapered Leg with Glide



Tapered Leg with Caster

D x W x H					
Thermally fused:					
GC3-1336L	13 x 36 x 1	70	15	0.9	<b>\$702</b>

High pressure:					
GC3-1336H	13 x 36 x 1	70	15	0.9	<b>\$1037</b>

Attachable fixed height tablet for Enable tables. Adds 10.5" per tablet to the depth of the table. Heavy duty Black mounting bracket slips onto the table top. Thumbscrews are included and attach into predrilled metal inserts for metal-to-metal fastening and security. 2 cartons.

LLL291	5.25 x 5.25 x 28	100	4.8	0.52	<b>\$156</b>
LLL294	5.25 x 5.25 x 28	100	18.4	2.1	<b>\$599</b>

- Hardware for assembly is included.

Support leg with glide. 1.5" glide range adjustment.

- LLL291: 1 per carton
- LLL294: 4 per carton
- Available in Black (**BLK**), Shadow (**SHW**), Storm Grey (**SOG**), Toast (**TOA**), and Tungsten (**TUN**). Finish must be specified at the time of order.

LCL291		100	4.8	0.52	<b>\$156</b>
LCL294		100	18.4	2.1	<b>\$599</b>

- Hardware for assembly is included.

Support leg with lockable caster.

- LCL291: 1 per carton
- LCL294: 4 per carton
- Available in Black (**BLK**), Shadow (**SHW**), Storm Grey (**SOG**), Toast (**TOA**), and Tungsten (**TUN**). Finish must be specified at the time of order.

PACKAGES

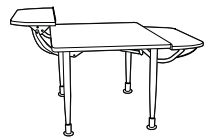

Package A

GCHATAL	64 x 42 x 29	100	120.5	13.83	<b>\$5093</b>
---------	--------------	-----	-------	-------	---------------

Thermally fused

GCHATAH	64 x 42 x 29	100	120.5	13.83	<b>\$6310</b>
---------	--------------	-----	-------	-------	---------------

High pressure

- Table top
- Metal inserts pre-drilled for tablets
- Two EZ-lift dual arm tablets
- 4 cartons.
- Four tapered Legs on glides
- All hardware

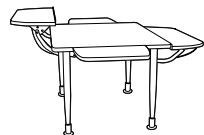

Package B

GCHATBL	68 x 64 x 29	100	135.5	14.4	<b>\$6359</b>
---------	--------------	-----	-------	------	---------------

Thermally fused

GCHATBH	64 x 42 x 29	100	135.5	14.4	<b>\$8239</b>
---------	--------------	-----	-------	------	---------------

High pressure

- Table top
- Metal inserts pre-drilled for tablets
- Two EZ-lift dual arm tablets
- 6 cartons.
- 2 fixed tablets
- Four tapered Legs on glides
- All hardware



NOTES

D x W x H



- Attractive top design offers an inward curve at each corner allowing comfortable access if assistance with eating is required.
- Adjustable 1.5" range Black plastic glides are standard except Tungsten (**TUN**) which has Tungsten glides.
- Heavy duty tapered steel legs available in Black (**BLK**), Shadow (**SHW**), Toast (**TOA**), Storm Grey (**SOG**) and Tungsten (**TUN**). Please specify leg finish color when placing order. Latte (**LAB**), Mocha (**J52**), and Kalua (**KAL**) are also available by special request.
- Optional leg on caster available if required.
- Shipped easy to assemble.
- 2mm edging color coordinated with laminate finish is standard for all tops. Finish must be specified at the time of order.
- Tops are 1" thick and available in thermally fused laminate (**LP**) and high pressure laminate (**HP**). Please select the appropriate model number for the finish you prefer
- Refer to the following lists when selecting a finish color. Must specify both a top color and leg finish at time of order.
- For custom laminate or contrasting edge, please contact your Global sales representative for special quotation.

**Thermally Fused Laminate (L)**

- Absolute Acajou (ACJ)
- Asian Night (ASN)
- Avant Cherry (AWC)
- Avant Honey (AWH)
- Brushed Cobalt (BRC)
- Clear Maple (CMB)
- Dark Espresso (DES)
- Designer White (DWT)
- Hayden Grey (HGT)
- Noce Biondo (NBL)
- Noce Grigio (NGL)
- Noce Leggero (NEL)
- Noce Medio (NML)
- Quartered Mahogany (QTM)
- Tiger Fruitwood (TFW)
- Tiger Walnut (TWL)
- Walnut Heights (WHE)
- White Chocolate (WHC)
- Winter Cherry (WCR)

**High Pressure Laminate (H)**

- Absolute Acajou (ACJ)
- Asian Night (ASN)
- Avant Cherry (W357)
- Avant Honey (W356)
- Brushed Cobalt (BRC)
- Clear Maple (CMB)
- Dark Espresso (W142)
- Designer White (DWT)
- Hayden Grey (HGT)
- Noce Biondo (NBL)
- Noce Grigio (NGL)
- Noce Leggero (NEL)
- Noce Medio (NML)
- Quartered Mahogany (QTM)
- Tiger Fruitwood (TFW)
- Tiger Walnut (W819)
- Walnut Heights (WHE)
- White Chocolate (WHC)
- Winter Cherry (WCR)

	MODEL#	DIMENSIONS	FREIGHT CLASS	WT/LBS.	CUBIC FT.	LIST PRICE
	GCF-42L	42 x 42 x 29	70	79	4.14	<b>\$1774</b>
	GCF-42H	42 x 42 x 29	70	79	4.14	<b>\$2226</b>
<ul style="list-style-type: none"> <li>• For a thermally fused top (L), specify model GCF-42L.</li> <li>• For a high pressure laminate top (H), specify model GCF-42H.</li> </ul>						
<p>42" x 42" thermally fused laminate top. Four legs.</p> <ul style="list-style-type: none"> <li>• Additional leg heights are available. Special quote is required.</li> <li>• 2 cartons</li> </ul>						
	GCF-48L	48 x 48 x 29	70	98	4.7	<b>\$1852</b>
	GCF-48H	48 x 48 x 29	70	98	4.7	<b>\$2460</b>
<ul style="list-style-type: none"> <li>• For a thermally fused top (L), specify model GCF-48L.</li> <li>• For a high pressure laminate top (H), specify model GCF-48H.</li> </ul>						
<p>48" x 48" thermally fused laminate top. Four legs.</p> <ul style="list-style-type: none"> <li>• Additional leg heights are available. Special quote is required.</li> <li>• 2 cartons</li> </ul>						

**Floral Dining Room Table - 42"**

**Floral Dining Room Table - 48"**

NOTES

D x W x H

- Elliptical metal tube frame available in Black (BLK), Shadow (SHW), Toast (TOA), Tungsten (TUN), Latte (LAB), Mocha (J52), and Kalua (KAL). Please specify leg finish color when placing order.
- Freestanding tables coordinate with GC-Belong and Strand seating series. Table Bridges can be mounted only to GC-Belong ganging seating or bench units. Table Bridges do not have legs. All bridge models can be ganged to seat units with link. Please refer to the seating section for more information on Ganging.
- Tables are 16" high
- Please specify all substitutions and options
- 1" thick tops are available in thermally fused laminate (L) and high pressure laminate (H). Please select the appropriate model number for the finish you prefer.
- 3mm edging color coordinated with laminate finish is standard for all tops. Finish MUST BE specified at the time of order.
- Refer to the following lists when selecting a finish color. MUST Specify both a Top Color and Leg Finish when ordering.
- For custom laminate or contrasting edge, please contact your Global sales representative for special quotation.

Thermally Fused Laminate (L)

- Absolute Acajou (ACJ)
- Asian Night (ASN)
- Avant Cherry (AWC)
- Avant Honey (AWH)
- Brushed Cobalt (BRC)
- Clear Maple (CMB)
- Dark Espresso (DES)
- Designer White (DWT)
- Hayden Grey (HGT)
- Noce Biondo (NBL)
- Noce Grigio (NGL)
- Noce Leggero (NEL)
- Noce Medio (NML)
- Quartered Mahogany (QTM)
- Tiger Fruitwood (TFW)
- Tiger Walnut (TWL)
- Walnut Heights (WHE)
- White Chocolate (WHC)
- Winter Cherry (WCR)

High Pressure Laminate (H)

- Absolute Acajou (ACJ)
- Asian Night (ASN)
- Avant Cherry (W357)
- Avant Honey (W356)
- Brushed Cobalt (BRC)
- Clear Maple (CMB)
- Dark Espresso (W142)
- Designer White (DWT)
- Hayden Grey (HGT)
- Noce Biondo (NBL)
- Noce Grigio (NGL)
- Noce Leggero (NEL)
- Noce Medio (NML)
- Quartered Mahogany (QTM)
- Tiger Fruitwood (TFW)
- Tiger Walnut (W819)
- Walnut Heights (WHE)
- White Chocolate (WHC)
- Winter Cherry (WCR)

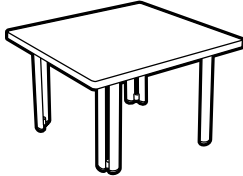
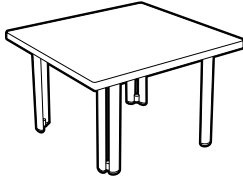
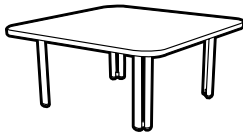
	MODEL#	DIMENSIONS	FREIGHT CLASS	WT/LBS.	CUBIC FT.	LIST PRICE
 <p><b>Rectangular End Table</b></p>	GC4281-LP	22 x 18 x 16	100	30	3.4	<b>\$895</b>
	GC4281-HP	22 x 18 x 16	100	30	3.4	<b>\$1012</b>
<ul style="list-style-type: none"> <li>• For a thermally fused laminate top (LP), specify model GC4281-LP.</li> <li>• For a high pressure laminate top (HP), specify model GC4281-HP.</li> </ul> <p>Coordinating 3mm edge. Oval steel tube legs.</p>						
 <p><b>Square End Table</b></p>	GC4288-LP	23 x 23 x 16	100	31	3.4	<b>\$1022</b>
	GC4288-HP	23 x 23 x 16	100	31	3.4	<b>\$1136</b>
<ul style="list-style-type: none"> <li>• For a thermally fused laminate top (LP), specify model GC4288-LP.</li> <li>• For a high pressure laminate top (HP), specify model GC4288-HP.</li> </ul> <p>Coordinating 3mm edge. Oval steel tube legs.</p>						
 <p><b>Square End Table</b></p>	GC4282-LP	30 x 30 x 16	150	34	6	<b>\$1147</b>
	GC4282-HP	30 x 30 x 16	150	34	6	<b>\$1280</b>
<ul style="list-style-type: none"> <li>• For a thermally fused laminate top (LP), specify model GC4282-LP.</li> <li>• For a high pressure laminate top (HP), specify model GC4282-HP.</li> </ul> <p>Coordinating 3mm edge. Oval steel tube legs.</p>						

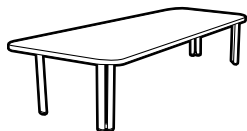

**Rectangular Coffee Table**



**Square Coffee Table**

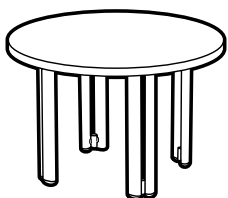

**Round Coffee Table - 24" Diameter**

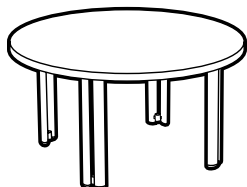

**Round Coffee Table - 30" Diameter**

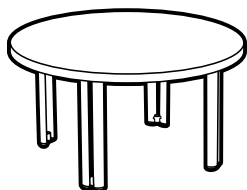

**Round Coffee Table 36" Diameter**

MODEL#	DIMENSIONS	FREIGHT CLASS	WT/LBS.	CUBIC FT.	LIST PRICE
--------	------------	---------------	---------	-----------	------------

D x W x H

GC4283-LP	54 x 22 x 16	125	37	6	<b>\$1155</b>
GC4283-HP	54 x 22 x 16	125	37	6	<b>\$1347</b>

- For a thermally fused laminate top (LP), specify model GC4283-LP.
- For a high pressure laminate top (HP), specify model GC4283-HP.

Coordinating 3mm edge. Oval steel tube legs

GC4284-LP	36 x 36 x 16	125	37	6	<b>\$1205</b>
GC4284-HP	36 x 36 x 16	125	37	6	<b>\$1347</b>

- For a thermally fused laminate top (LP), specify model GC4284-LP.
- For a high pressure laminate top (HP), specify model GC4284-HP.

Coordinating 3mm edge. Oval steel tube legs

GC4285-LP	24 x 24 x 16	100	33	3.4	<b>\$1123</b>
GC4285-HP	24 x 24 x 16	100	33	3.4	<b>\$1213</b>

- For a thermally fused laminate top (LP), specify model GC4285-LP.
- For a high pressure laminate top (HP), specify model GC4285-HP.

Coordinating 3mm edge. Oval steel tube legs

GC4286-LP	30 x 30 x 16	150	34	6	<b>\$1127</b>
GC4286-HP	30 x 30 x 16	150	34	6	<b>\$1213</b>

- For a thermally fused laminate top (LP), specify model GC4286-LP.
- For a high pressure laminate top (HP), specify model GC4286-HP.

Coordinating 3mm edge. Oval steel tube legs

GC4287-LP	36 x 36 x 16	125	37	6	<b>\$1276</b>
GC4287-HP	36 x 36 x 16	125	37	6	<b>\$1416</b>

- For a thermally fused laminate top (LP), specify model GC4287-LP.
- For a high pressure laminate top (HP), specify model GC4287-HP.

Coordinating 3mm edge. Oval steel tube legs

TABLE BRIDGES	MODEL#	DIMENSIONS	FREIGHT CLASS	WT/LBS.	CUBIC FT.	LIST PRICE
---------------	--------	------------	---------------	---------	-----------	------------

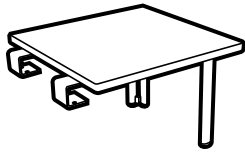

**End Table Bridge, Not Freestanding**

	D x W x H					
GC4274-LP	23 x 23 x 16	125	25	3.4		<b>\$736</b>
GC4274-HP	23 x 23 x 16	125	25	3.4		<b>\$787</b>

- For a thermally fused laminate top (LP), specify model GC4274-LP.
- For a high pressure laminate top (HP), specify model GC4274-HP.

**1 end suspends to a seating unit via linking brackets.** Coordinating 3mm edge. Oval steel tube legs Reversible.

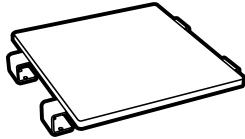

**Square Table Top, Not Freestanding**

GC4275-LP	23 x 23 x 1	150	18	3.4		<b>\$514</b>
GC4275-HP	23 x 23 x 1	150	18	3.4		<b>\$579</b>

- For a thermally fused laminate top (LP), specify model GC4275-LP.
- For a high pressure laminate top (HP), specify model GC4275-HP.

**Suspends between two seating units via linking brackets.** Coordinating 3mm edge No legs. Reversible.



**End Corner Table Bridge  
Not Freestanding**

GC4277-LP	35 x 35 x 16	125	45	6		<b>\$820</b>
GC4277-HP	35 x 35 x 16	125	45	6		<b>\$936</b>

- For a thermally fused laminate top (LP), specify model GC4277-LP.
- For a high pressure laminate top (HP), specify model GC4277-HP.

**Suspends between two seating units via linking brackets.** Coordinating 3mm edge. Oval steel tube legs Can be used for right or left corner.



**End Corner Curve Table Bridge  
Not Freestanding**

GC4278-LP	35 x 35 x 16	125	45	6		<b>\$820</b>
GC4278-HP	35 x 35 x 16	125	45	6		<b>\$936</b>

- For a thermally fused laminate top (LP), specify model GC4278-LP.
- For a high pressure laminate top (HP), specify model GC4278-HP.

**Suspends between two seating units via linking brackets.** Coordinating 3mm edge. Oval steel tube legs Can be used for right or left corner.

NOTES	MODEL#	DIMENSIONS D x W x H	FREIGHT CLASS	WT/LBS.	CUBIC FT.	LIST PRICE
-------	--------	-------------------------	---------------	---------	-----------	------------

- Select from Chippendale (**C**), Post (**P**) or Tapered (**T**) leg options to coordinate with traditional or contemporary decor.
- Solid wood legs and aprons are standard.
- Shipped RTA (ready to assemble).
- 1" thick tops are available in thermally fused laminate (**LP**), high pressure laminate (**HP**) or solid hardwood (**W**). Please select the appropriate model number for the finish you prefer.
- Thermally fused laminate (**LP**) and high pressure laminate (**HP**) tops come with 2mm edging color coordinated with laminate finish. Finish must be specified at time of order.
- Solid hardwood tops come with decorative edge detail to coordinate with the leg selected. Chippendale legs come with beveled edge. Post legs comes with bullnose edge. Tapered leg comes with reverse knife cut edge. See pictures below.
- Refer to the following lists when selecting a finish color. Must specify both a top color and base color when ordering all tables.
- Thermally fused and HP laminate tops cannot be manufactured with the exact finish color on the base.
- For custom laminate, custom wood stain or contrasting edge, please contact your Global sales representative for a special quotation.

**Thermally Fused Laminate (LP) Tops**

Absolute Acajou (ACJ)  
Asian Night (ASN)  
Avant Cherry (AWC)  
Avant Honey (AWH)  
Brushed Cobalt (BRC)  
Clear Maple (CMB)  
Dark Espresso (DES)  
Designer White (DWT)  
Hayden Grey (HGT)  
Noce Biondo (NBL)  
Noce Grigio (NGL)  
Noce Leggero (NEL)  
Noce Medio (NML)  
Quartered Mahogany (QTM)  
Tiger Fruitwood (TFW)  
Tiger Walnut (TWL)  
Walnut Heights (WHE)  
White Chocolate (WHC)  
Winter Cherry (WCR)

**Suggested coordinating wood finish**

Absolute (AAM)  
Night (ASM)  
Cherry (ACM)  
Honey (AHM)  
Light Honey (LHM)  
Maple (AVM)  
Espresso Cafe (ECM)  
White (WHM)  
Gray (HGM)  
Noce Biondo (NBM)  
Noce Grigio (NGM)  
Noce Leggero (NEM)  
Noce Medio (NMM)  
Mahogany (TMM)  
Fruitwood (TFM)  
Walnut (TWM)  
Natural Walnut (NLW)  
WC Cream (WTM)  
Winter Cherry (WCM)

**High Pressure Laminate (HP) Tops**

Absolute Acajou (ACJ)  
Asian Night (ASN)  
Avant Cherry (W357)  
Avant Honey (W356)  
Brushed Cobalt (BRC)  
Clear Maple (CMB)  
Dark Espresso (W142)  
Designer White (DWT)  
Hayden Grey (HGT)  
Noce Biondo (NBL)  
Noce Grigio (NGL)  
Noce Leggero (NEL)  
Noce Medio (NML)  
Quartered Mahogany (QTM)  
Tiger Fruitwood (TFW)  
Tiger Walnut (W819)  
Walnut Heights (WHE)  
White Chocolate (WHC)  
Winter Cherry (WCR)

**Suggested coordinating wood finish**

Absolute (AAM)  
Night (ASM)  
Cherry (ACM)  
Honey (AHM)  
Light Honey (LHM)  
Maple (AVM)  
Espresso Cafe (ECM)  
White (WHM)  
Gray (HGM)  
Noce Biondo (NBM)  
Noce Grigio (NGM)  
Noce Leggero (NEM)  
Noce Medio (NMM)  
Mahogany (TMM)  
Fruitwood (TFM)  
Walnut (TWM)  
Natural Walnut (NLW)  
WC Cream (WTM)  
Winter Cherry (WCM)

**Wood Finishes (W) - top, base, legs and apron:**

Absolute (AAM)  
Charcoal Java (CJM)  
Cherry (ACM)  
Empire Mahogany (EMM)  
English Oak (EOM)  
Espresso Cafe (ECM)  
Fruitwood (TFM)  
Gray (HGM)  
Harvest Oak (HOM)  
Honey (AHM)  
Jet Onyx (JOM)  
Light Honey (LHM)  
Mahogany (TMM)  
Maple (AVM)  
Medium Walnut (MWM)  
Natural Walnut (NLW)  
Night (ASM)  
Noce Biondo (NBM)  
Noce Grigio (NGM)  
Noce Leggero (NEM)  
Noce Medio (NMM)  
Sandy Beach (SBM)  
Shaker Cherry (SKM)  
Silver Oak (SOM)  
Walnut (TWM)  
White (WHM)  
WC Cream (WTM)  
Winter Cherry (WCM)

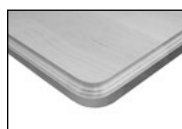
**Table edges - wood tops**

Beveled edge



Bullnose edge

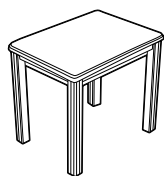

Reverse knife cut edge

**OCCASIONAL TABLES****Rectangular End Table**

MODEL#	DIMENSIONS	FREIGHT CLASS	WT/LBS.	CUBIC FT.	LIST PRICE
--------	------------	---------------	---------	-----------	------------

GC3760-LC	24 x 18 x 21	150	26.26	5.25	<b>\$888</b>
GC3760-HC	24 x 18 x 21	150	26.26	5.25	<b>\$1017</b>
GC3760-WC	24 x 18 x 21.25	150	27.12	5.25	<b>\$1064</b>

- For a thermally fused top (L), specify model GC3760-LC.
- For a high pressure laminate top (H), specify model GC3760-HC.
- For a wood top (W), specify model GC3760-WC.

Features **Chippendale** legs. 21" high. Standard with solid wood legs and apron.

MODEL#	DIMENSIONS	FREIGHT CLASS	WT/LBS.	CUBIC FT.	LIST PRICE
--------	------------	---------------	---------	-----------	------------

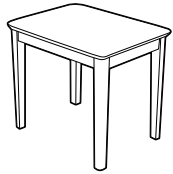

Rectangular End Table

	D x W x H				
GC3760-LT	24 x 18 x 21	150	24.69	5.25	<b>\$888</b>
GC3760-HT	24 x 18 x 21	150	24.69	5.25	<b>\$1017</b>
GC3760-WT	24 x 18 x 21.25	150	25.55	5.5	<b>\$1064</b>

- For a thermally fused top (L), specify model GC3760-LT.
- For a high pressure laminate top (H), specify model GC3760-HT.
- For a wood top (W), specify model GC3760-WT.

Features **Tapered** legs. 21" high. Standard with solid wood legs and apron.

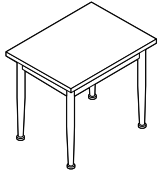

Rectangular End Table

GC3760-LP	24 x 18 x 21	150	26.3	5.25	<b>\$1588</b>
GC3760-HP	24 x 18 x 21	150	26.3	5.25	<b>\$1680</b>
GC3760-WP	24 x 18 x 21	150	27.1	5.25	<b>\$1651</b>

- For a thermally fused top (L), specify model GC3760-LP
- For a high pressure laminate top (H), specify model GC3760-HP
- For a wood top (W), specify model GC3760-WP

Features **Post** legs. 21" high. Standard with solid wood legs and apron. Post legs are 1 1/3" in diameter.

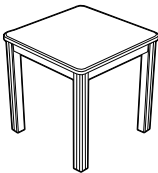

Square End Table

GC3761-LC	21 x 21 x 21	150	26.48	5.5	<b>\$888</b>
GC3761-HC	21 x 21 x 21	150	26.48	5.5	<b>\$1017</b>
GC3761-WC	21 x 21 x 21.25	150	27.36	5.5	<b>\$1064</b>

- For a thermally fused top (L), specify model GC3761-LC.
- For a high pressure laminate top (H), specify model GC3761-HC.
- For a wood top (W), specify model GC3761-WC.

Features **Chippendale** legs. 21" high. Standard with solid wood legs and apron.

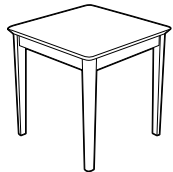

Square End Table

GC3761-LT	21 x 21 x 21	150	24.91	5.5	<b>\$888</b>
GC3761-HT	21 x 21 x 21	150	24.91	5.5	<b>\$1017</b>
GC3761-WT	21 x 21 x 21.25	150	25.79	5.5	<b>\$1064</b>

- For a thermally fused top (L), specify model GC3761-LT.
- For a high pressure laminate top (H), specify model GC3761-HT.
- For a wood top (W), specify model GC3761-WT.

Features **Tapered** legs. 21" high. Standard with solid wood legs and apron.

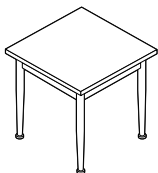

Square End Table

GC3761-LP	21 x 21 x 21	150	26.5	5.5	<b>\$1660</b>
GC3761-HP	21 x 21 x 21	150	26.5	5.5	<b>\$1735</b>
GC3761-WP	21 x 21 x 21	150	27.4	5.5	<b>\$1651</b>

- For a thermally fused top (L), specify model GC3761-LP
- For a high pressure laminate top (H), specify model GC3761-HP
- For a wood top (W), specify model GC3761-WP

Features **Post** legs. 21" high. Standard with solid wood legs and apron. Post legs are 1 1/3" in diameter.

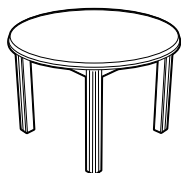

Round End Table

GC3762-LC	24 x 24 x 21	250	26.12	7	<b>\$916</b>
GC3762-HC	24 x 24 x 21	250	26.12	7	<b>\$1093</b>
GC3762-WC	24 x 24 x 21.25	250	27.02	7	<b>\$1140</b>

- For a thermally fused top (L), specify model GC3762-LC.
- For a high pressure laminate top (H), specify model GC3762-HC.
- For a wood top (W), specify model GC3762-WC.

Features **Chippendale** legs. 21" high. Standard with solid wood legs and apron.



Round End Table

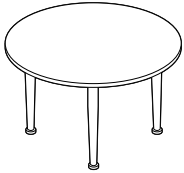

Round End Table

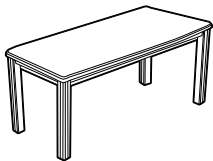

Rectangular Coffee Table

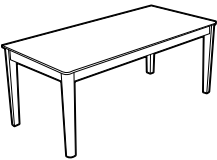

Rectangular Coffee Table

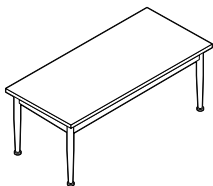

Rectangular Coffee Table

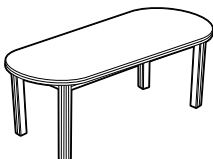

Oval Coffee Table

MODEL#	DIMENSIONS D x W x H	FREIGHT CLASS	WT./LBS.	CUBIC FT.	LIST PRICE
GC3762-LT	24 x 24 x 21	250	24	8.5	<b>\$916</b>
GC3762-HT	24 x 24 x 21	250	24.55	8.5	<b>\$1093</b>
GC3762-WT	24 x 24 x 21.25	250	25.45	8.5	<b>\$1140</b>

- For a thermally fused top (L), specify model GC3762-LT.
- For a high pressure laminate top (H), specify model GC3762-HT.
- For a wood top (W), specify model GC3762-WT.

Features **Tapered** legs. 21" high. Standard with solid wood legs and apron.

GC3762-LP	24 x 24 x 21	250	26.1	7	<b>\$1647</b>
GC3762-HP	24 x 24 x 21	250	26.1	7	<b>\$1787</b>
GC3762-WP	24 x 24 x 21	250	27	7	<b>\$1762</b>

- For a thermally fused top (L), specify model GC3762-LP
- For a high pressure laminate top (H), specify model GC3762-HP.
- For a wood top (W), specify model GC3762-WP.

Features **Post** legs. 22" high. Post legs are 1 1/3" in diameter.

GC3763-LC	48 x 22 x 19	250	43.73	11.75	<b>\$1068</b>
GC3763-HC	48 x 22 x 19	250	43.73	11.75	<b>\$1363</b>
GC3763-WC	48 x 22 x 19.25	250	45.83	11.75	<b>\$1441</b>

- For a thermally fused top (L), specify model GC3763-LC.
- For a high pressure laminate top (H), specify model GC3763-HC.
- For a wood top (W), specify model GC3763-WC.

Features **Chippendale** legs. 19" high. Standard with solid wood legs and apron.

GC3763-LT	48 x 22 x 19	250	42.27	11.75	<b>\$1068</b>
GC3763-HT	48 x 22 x 19	250	42.27	11.75	<b>\$1363</b>
GC3763-WT	48 x 22 x 19.25	250	44.38	11.75	<b>\$1441</b>

- For a thermally fused top (L), specify model GC3763-LT.
- For a high pressure laminate top (H), specify model GC3763-HT.
- For a wood top (W), specify model GC3763-WT.

Features **Tapered** legs. 19" high. Standard with solid wood legs and apron.

GC3763-LP	48 x 22 x 19	250	43.7	11.75	<b>\$1783</b>
GC3763-HP	48 x 22 x 19	250	43.7	11.75	<b>\$2061</b>
GC3763-WP	48 x 22 x 19	250	45.8	11.75	<b>\$2110</b>

- For a thermally fused top (L), specify model GC3763-LP.
- For a high pressure laminate top (H), specify model GC3763-HP.
- For a wood top (W), specify model GC3763-WP.

Features **Post** legs. 19" high. Standard with solid wood legs and apron. Post legs are 1 1/3" in diameter.

GC3764-LC	46 x 22 x 19	250	38.58	11.5	<b>\$1027</b>
GC3764-HC	46 x 22 x 19	250	38.58	11.5	<b>\$1320</b>
GC3764-WC	46 x 22 x 19.25	250	38.4	11.5	<b>\$1401</b>

- For a thermally fused top (L), specify model GC3764-LC.
- For a high pressure laminate top (H), specify model GC3764-HC.
- For a wood top (W), specify model GC3764-WC.

Features **Chippendale** legs. 19" high. Standard with solid wood legs and apron.

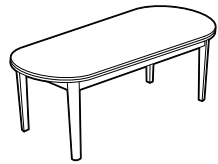

Oval Coffee Table

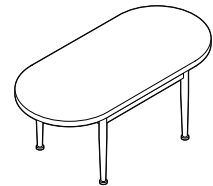

Oval Coffee Table

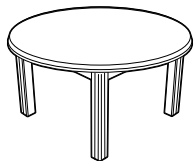

Round Coffee Table



Round Coffee Table

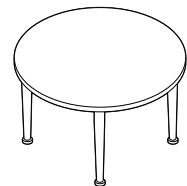

Round Coffee Table

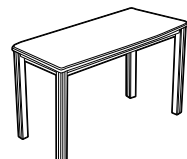

Rectangular Sofa Table

MODEL#	DIMENSIONS D x W x H	FREIGHT CLASS	WT/LBS.	CUBIC FT.	LIST PRICE
--------	-------------------------	---------------	---------	-----------	------------

GC3764-LT	46 x 22 x 19	250	37.13	11.5	<b>\$1027</b>
GC3764-HT	46 x 22 x 19	250	37.13	11.5	<b>\$1320</b>
GC3764-WT	46 x 22 x 19.25	250	36.94	11.5	<b>\$1401</b>

- For a thermally fused top (L), specify model GC3764-LT.
- For a high pressure laminate top (H), specify model GC3764-HT.
- For a wood top (W), specify model GC3764-WT.

Features **Tapered** legs. 19" high. Standard with solid wood legs and apron.

GC3764-LP	46 x 22 x 19	250	38.6	11.5	<b>\$1748</b>
GC3764-HP	46 x 22 x 19	250	38.6	11.5	<b>\$2034</b>
GC3764-WP	46 x 22 x 19	250	38.4	11.5	<b>\$2072</b>

- For a thermally fused top (L), specify model GC3763-LP.
- For a high pressure laminate top (H), specify model GC3763-HP.
- For a wood top (W), specify model GC3763-WP.

Features **Post** legs. 19" high. Standard with solid wood legs and apron. Post legs are 1 1/3" in diameter.

GC3765-LC	32 x 32 x 19	250	35.15	11.5	<b>\$1052</b>
GC3765-HC	32 x 32 x 19	250	35.15	11.5	<b>\$1346</b>
GC3765-WC	32 x 32 x 19.25	250	36.76	11.5	<b>\$1430</b>

- For a thermally fused top (L), specify model GC3765-LC.
- For a high pressure laminate top (H), specify model GC3765-HC.
- For a wood top (W), specify model GC3765-WC.

Features **Chippendale** legs. 19" high. Standard with solid wood legs and apron.

GC3765-LT	32 x 32 x 19	250	33.69	11.5	<b>\$1052</b>
GC3765-HT	32 x 32 x 19	250	33.69	11.5	<b>\$1346</b>
GC3765-WT	32 x 32 x 19.25	250	35.3	11.5	<b>\$1430</b>

- For a thermally fused top (L), specify model GC3765-LT.
- For a high pressure laminate top (H), specify model GC3765-HT.
- For a wood top (W), specify model GC3765-WT.

Features **Tapered** legs. 19" high. Standard with solid wood legs and apron.

GC3765-LP	32 x 32 x 19	250	35.2	11.5	<b>\$1775</b>
GC3765-HP	32 x 32 x 19	250	35.2	11.5	<b>\$2089</b>
GC3765-WP	32 x 32 x 19	250	36.8	11.5	<b>\$2081</b>

- For a thermally fused top (L), specify model GC3765-LP.
- For a high pressure laminate top (H), specify model GC3765-HP.
- For a wood top (W), specify model GC3765-WP.

Features **Post** legs. 19" high. Standard with solid wood legs and apron. Post legs are 1 1/3" in diameter.

GC3766-LC	42 x 16 x 29	250	37.62	11.5	<b>\$993</b>
GC3766-HC	42 x 16 x 29	250	37.62	11.5	<b>\$1192</b>
GC3766-WC	42 x 16 x 29.25	250	38.07	11.5	<b>\$1231</b>

- For a thermally fused top (L), specify model GC3766-LC.
- For a high pressure laminate top (H), specify model GC3766-HC.
- For a wood top (W), specify model GC3766-WC.

Features **Chippendale** legs. 29" high. Standard with solid wood legs and apron.



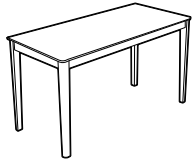

Rectangular Sofa Table

MODEL#	DIMENSIONS D x W x H	FREIGHT CLASS	WT/LBS.	CUBIC FT.	LIST PRICE
GC3766-LT	42 x 16 x 29	250	34.58	11.5	\$993
GC3766-HT	42 x 16 x 29	250	34.58	11.5	\$1192
GC3766-WT	42 x 16 x 29.25	250	35.92	11.5	\$1231

- For a thermally fused top (L), specify model GC3766-LT.
- For a high pressure laminate top (H), specify model GC3766-HT.
- For a wood top (W), specify model GC3766-WT.

Features **Tapered** legs. 29" high. Standard with solid wood legs and apron.

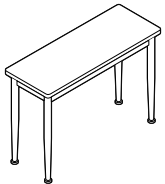

Rectangular Sofa Table

GC3766-LP	42 x 16 x 29	250	37.6	11.5	\$1713
GC3766-HP	42 x 16 x 29	250	37.6	11.5	\$1876
GC3766-WP	42 x 16 x 29	250	38.1	11.5	\$2299

- For a thermally fused top (L), specify model GC3766-LP.
- For a high pressure laminate top (H), specify model GC3766-HP.
- For a wood top (W), specify model GC3766-WP.

Features **Post** legs. 29" high. Standard with solid wood legs and apron. Post legs are 1 1/3" in diameter.

DINING TABLES

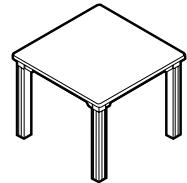

Square Dining Table

MODEL#	DIMENSIONS	FREIGHT CLASS	WT/LBS.	CUBIC FT.	LIST PRICE
GC3772-LC	36 x 36 x 29	85	50	3.9	\$1910
GC3772-HC	36 x 36 x 29	85	50	3.9	\$2130
GC3772-WC	36 x 36 x 29	85	50	3.9	\$3033

- For a thermally fused top (L), specify model GC3772-LC.
- For a high pressure laminate top (H), specify model GC3772-HC.
- For a wood top (W), specify model GC3772-WC.

Features **Chippendale** legs. 29" high. Standard with solid wood legs and apron.

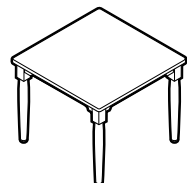

Square Dining Table

GC3772-LP	36 x 36 x 29	85	50	3.9	\$1910
GC3772-HP	36 x 36 x 29	85	50	3.9	\$2130
GC3772-WP	36 x 36 x 29	85	50	3.9	\$3033

- For a thermally fused top (L), specify model GC3772-LP.
- For a high pressure laminate top (H), specify model GC3772-HP.
- For a wood top (W), specify model GC3772-WP.

Features **Post** legs. 29" high. Standard with solid wood legs and apron. Post legs are 1 1/3" in diameter.

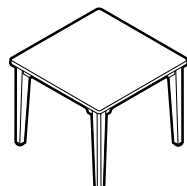

Square Dining Table

GC3772-LT	36 x 36 x 29	85	50	3.9	\$1910
GC3772-HT	36 x 36 x 29	85	50	3.9	\$2130
GC3772-WT	36 x 36 x 29	85	50	3.9	\$3033

- For a thermally fused top (L), specify model GC3772-LT.
- For a high pressure laminate top (H), specify model GC3772-HT.
- For a wood top (W), specify model GC3772-WT.

Features **Tapered** legs. 29" high. Standard with solid wood legs and apron.

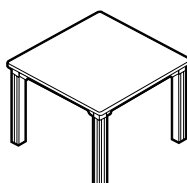

Square Dining Table

GC3773-LC	42 x 42 x 29	85	68	5.5	\$2054
GC3773-HC	42 x 42 x 29	85	68	5.5	\$2354
GC3773-WC	42 x 42 x 29	85	68	5.5	\$3669

- For a thermally fused top (L), specify model GC3773-LC.
- For a high pressure laminate top (H), specify model GC3773-HC.
- For a wood top (W), specify model GC3773-WC.

Features **Chippendale** legs. 29" high. Standard with solid wood legs and apron.

# TABLES

# OCCASIONAL

0

DINING TABLES	MODEL#	DIMENSIONS	FREIGHT CLASS	WT/LBS.	CUBIC FT.	LIST PRICE
---------------	--------	------------	---------------	---------	-----------	------------

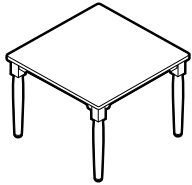

**Square Dining Table**

	D x W x H					
GC3773-LP	42 x 42 x 29	85	68	5.5		<b>\$2054</b>
GC3773-HP	42 x 42 x 29	85	68	5.5		<b>\$2354</b>
GC3773-WP	42 x 42 x 29	85	68	5.5		<b>\$3669</b>

- For a thermally fused top (L), specify model GC3773-LP.
- For a high pressure laminate top (H), specify model GC3773-HP.
- For a wood top (W), specify model GC3773-WP.

Features **Post** legs. 29" high. Standard with solid wood legs and apron. Post legs are 1 1/3" in diameter.

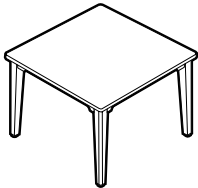

**Square Dining Table**

GC3773-LT	42 x 42 x 29	85	68	5.5		<b>\$2054</b>
GC3773-HT	42 x 42 x 29	85	68	5.5		<b>\$2354</b>
GC3773-WT	42 x 42 x 29	85	68	5.5		<b>\$3669</b>

- For a thermally fused top (L), specify model GC3773-LT.
- For a high pressure laminate top (H), specify model GC3773-HT.
- For a wood top (W), specify model GC3773-WT.

Features **Tapered** legs. 29" high. Standard with solid wood legs and apron.

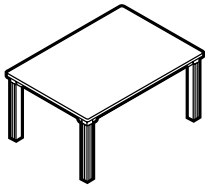

**Rectangular Dining Table**

GC3774-LC	60 x 42 x 29	85	97	7.5		<b>\$2339</b>
GC3774-HC	60 x 42 x 29	85	97	7.5		<b>\$2767</b>
GC3774-WC	60 x 42 x 29	85	97	7.5		<b>\$4590</b>

- For a thermally fused top (L), specify model GC3774-LC.
- For a high pressure laminate top (H), specify model GC3774-HC.
- For a wood top (W), specify model GC3774-WC.

Features **Chippendale** legs. 29" high. Standard with solid wood legs and apron.

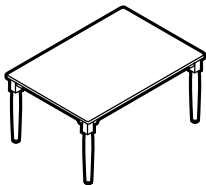

**Rectangular Dining Table**

GC3774-LP	60 x 42 x 29	85	97	7.5		<b>\$2339</b>
GC3774-HP	60 x 42 x 29	85	97	7.5		<b>\$2767</b>
GC3774-WP	60 x 42 x 29	85	97	7.5		<b>\$4590</b>

- For a thermally fused top (L), specify model GC3774-LP.
- For a high pressure laminate top (H), specify model GC3774-HP.
- For a wood top (W), specify model GC3774-WP.

Features **Post** legs. 29" high. Standard with solid wood legs and apron. Post legs are 1 1/3" in diameter.

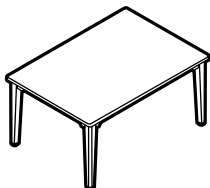

**Rectangular Dining Table**

GC3774-LT	60 x 42 x 29	85	97	7.5		<b>\$2339</b>
GC3774-HT	60 x 42 x 29	85	97	7.5		<b>\$2767</b>
GC3774-WT	60 x 42 x 29	85	97	7.5		<b>\$4590</b>

- For a thermally fused top (L), specify model GC3774-LT.
- For a high pressure laminate top (H), specify model GC3774-HT.
- For a wood top (W), specify model GC3774-WT.

Features **Tapered** legs. 29" high. Standard with solid wood legs and apron.

NOTES	MODEL#	DIMENSIONS D x W x H	FREIGHT CLASS	WT/LBS.	CUBIC FT.	LIST PRICE
-------	--------	-------------------------	---------------	---------	-----------	------------

**Notes:** Please specify all substitutions and options.

- Tops are available in various shapes: rectangular, kidney, peanut and jellybean shapes.
- Bases are available in three styles: H-base, U-base and C-base.
- Bases feature a shock-absorbent gas spring cylinder for easy height adjustment and exposed steel with no plastic cover for easy cleaning of base and casters.
- Manufactured with the lowest base (less than 2"H) in the industry, overbed tables can easily be moved under any patient bed or seating.
- Thermofoil top comes standard with seamless spillguard edge that holds up to 36 oz of liquid. For no spillguard, specify **(NSP)**. Add **\$87**.
- Overbed tables come standard with four non-locking casters.
- For two locking and two non-locking casters, please specify **2L** when ordering the overbed table. Add **\$37** each.
- For four locking casters, please specify **LC** when ordering the overbed table. Add **\$37** each.
- Refer to the following lists when selecting a finish color. Must specify both a top color and base color at time of order all tables.

#### Thermofoil Tops

Candlelight (TCL)  
Chocolate Pear (TCP)  
Hard Rock Maple (THM)  
Medium Cherry (TMC)  
Medium Oak (TMO)

#### Bases

Almond (AL)  
Graphite Grey (GG)  
Nevada (NV)

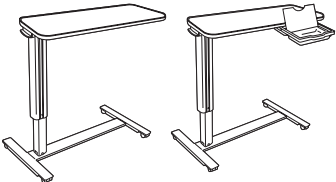
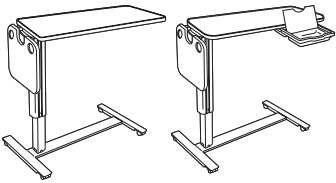
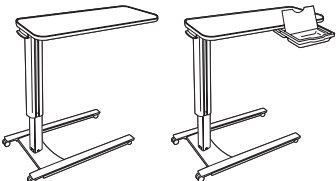
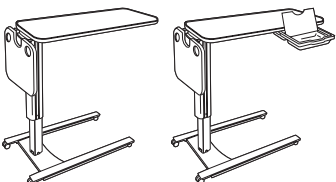
OVERBED TABLES	MODEL #	DIMENSIONS D x W x H	FREIGHT CLASS	WT/LBS.	CUBIC FT.	LIST PRICE
	GC3554	18 x 34 x 28-42	250	35	13.4	<b>\$1657</b>
	GC3554V w/Vanity drawer	18 x 34 x 28-42	250	37	13.4	<b>\$1910</b>
<b>Rectangular Thermofoil Spillguard Top w/H Base</b>						
						<ul style="list-style-type: none"> <li>• <i>Dual vanity drawer with mirror slides out from either side of the table.</i></li> </ul> <p>Thermofoil top with seamless spillguard edge. Height adjustable steel base. 1 per carton.</p>
	GC3554F	18 x 48 x 28-42	250	40	13.4	<b>\$2395</b>
	GC3554VF w/Vanity drawer	18 x 48 x 28-42	250	42	13.4	<b>\$2648</b>
<b>Rectangular Thermofoil Spillguard Top w/Flip-Top Surface and H Base</b>						
						<ul style="list-style-type: none"> <li>• <i>Dual vanity drawer with mirror slides out from either side of the table.</i></li> </ul> <p>Thermofoil top with seamless spillguard edge. One-hand activation flip-top provides a secondary surface with two cupholders, can hold up to 10 lbs. Height adjustable steel base. 1 per carton.</p>
	GC3555	19 x 34 x 28-42	250	35	13.4	<b>\$1572</b>
	GC3555V w/Vanity drawer	19 x 34 x 28-42	250	37	13.4	<b>\$1826</b>
<b>Rectangular Thermofoil Spillguard Top w/U Base</b>						
						<ul style="list-style-type: none"> <li>• <i>Dual vanity drawer with mirror slides out from either side of the table.</i></li> </ul> <p>Thermofoil top with seamless spillguard edge. Height adjustable steel base. 1 per carton.</p>
	GC3555F	19 x 46 x 28-42	250	40	13.4	<b>\$2310</b>
	GC3555VF w/Vanity drawer	19 x 46 x 28-42	250	42	13.37	<b>\$2563</b>
<b>Rectangular Thermofoil Spillguard Top w/Flip-Top Surface and U Base</b>						
						<ul style="list-style-type: none"> <li>• <i>Dual vanity drawer with mirror slides out from either side of the table.</i></li> </ul> <p>Thermofoil top with seamless spillguard edge. One-hand activation flip-top provides a secondary surface with two cupholders, can hold up to 10 lbs. Height adjustable steel base. 1 per carton.</p>

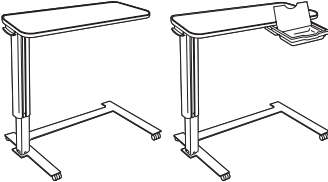
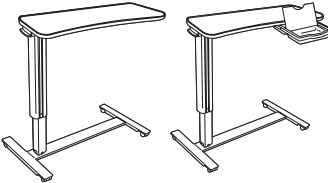
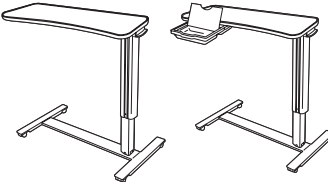
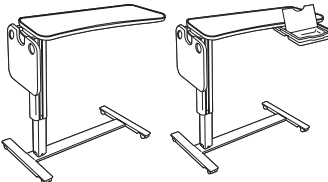
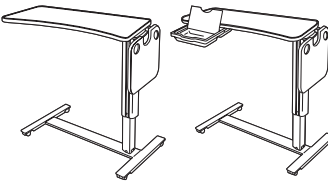
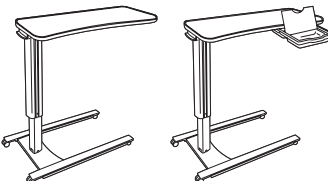
OVERBED TABLES	MODEL#	DIMENSIONS	FREIGHT CLASS	WT/LBS.	CUBIC FT.	LIST PRICE
 <p><b>Rectangular Thermofoil Spillguard Top w/C Base</b></p>		<b>D x W x H</b>				
	GC3556	21 x 32 x 28-42	300	35	19	<b>\$1770</b>
	GC3556V w/Vanity drawer	21 x 32 x 28-42	300	37	19	<b>\$2023</b>
						<ul style="list-style-type: none"> <li>• Dual vanity drawer with mirror slides out from either side of the table.</li> </ul> <p>Thermofoil top with seamless spillguard edge. Height adjustable steel base. 1 per carton.</p>
 <p><b>Kidney Shaped Thermofoil Spillguard Top w/H Base - LEFT</b></p>	GC3557L	19 x 34 x 28-42	250	35	13.4	<b>\$1735</b>
	GC3557LV w/Vanity drawer	19 x 34 x 28-42	250	37	13.4	<b>\$1990</b>
						<ul style="list-style-type: none"> <li>• Dual vanity drawer with mirror slides out from either side of the table.</li> </ul> <p><b>Left</b> hand side table. Thermofoil top with seamless spillguard edge. Height adjustable steel base. 1 per carton.</p>
 <p><b>Kidney Shaped Thermofoil Spillguard Top w/H Base - RIGHT</b></p>	GC3557R	19 x 34 x 28-42	250	35	13.4	<b>\$1735</b>
	GC3557RV w/Vanity drawer	19 x 34 x 28-42	250	37	13.4	<b>\$1990</b>
						<ul style="list-style-type: none"> <li>• Dual vanity drawer with mirror slides out from either side of the table.</li> </ul> <p><b>Right</b> hand side table. Thermofoil top with seamless spillguard edge. Height adjustable steel base. 1 per carton.</p>
 <p><b>Kidney Shaped Thermofoil Spillguard Top w/Flip-Top Surface and H-Base, LEFT</b></p>	GC3557LF	19 x 46 x 28-42	250	40	13.4	<b>\$2559</b>
	GC3557LVF w/Vanity drawer	19 x 46 x 28-42	250	42	13.4	<b>\$2811</b>
						<ul style="list-style-type: none"> <li>• Dual vanity drawer with mirror slides out from either side of the table.</li> </ul> <p><b>Left</b> hand side table. Thermofoil top with seamless spillguard edge. One-hand activation flip-top provides a secondary surface with two cupholders, can hold up to 10 lbs. Height adjustable steel base. 1 per carton.</p>
 <p><b>Kidney Shaped Thermofoil Spillguard Top w/Flip-Top Surface and H-Base, RIGHT</b></p>	GC3557RF	19 x 46 x 28-42	250	40	13.4	<b>\$2559</b>
	GC3557RVF w/Vanity drawer	19 x 46 x 28-42	250	42	13.4	<b>\$2811</b>
						<ul style="list-style-type: none"> <li>• Dual vanity drawer with mirror slides out from either side of the table.</li> </ul> <p><b>Right</b> hand side table. Thermofoil top with seamless spillguard edge. One-hand activation flip-top provides a secondary surface with two cupholders, can hold up to 10 lbs. Height adjustable steel base. 1 per carton.</p>
 <p><b>Kidney Shaped Thermofoil Spillguard Top w/U Base - LEFT</b></p>	GC3558L	19 x 34 x 28-42	250	35	13.4	<b>\$1652</b>
	GC3558LV w/Vanity drawer	19 x 34 x 28-42	250	37	13.4	<b>\$1905</b>
						<ul style="list-style-type: none"> <li>• Dual vanity drawer with mirror slides out from either side of the table.</li> </ul> <p><b>Left</b> hand side table. Thermofoil top with seamless spillguard edge. Height adjustable steel base. 1 per carton.</p>

# 0 OVERBED TABLES

## OVERBED TABLES

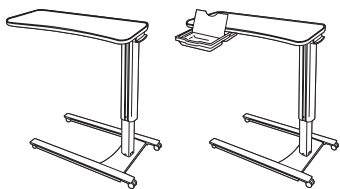

**Kidney Shaped Thermofoil Spillguard Top w/U Base - RIGHT**

MODEL#	DIMENSIONS D x W x H	FREIGHT CLASS	WT./LBS.	CUBIC FT.	LIST PRICE
GC3558R	19 x 34 x 28-42	250	35	13.4	<b>\$1652</b>
GC3558RV w/Vanity drawer	19 x 34 x 28-42	250	37	13.4	<b>\$1905</b>

- Dual vanity drawer with mirror slides out from either side of the table.

**Right** hand side table. Thermofoil top with seamless spillguard edge. Height adjustable steel base. 1 per carton.

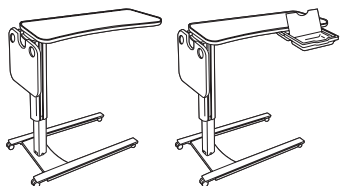

**Kidney Shaped Thermofoil Spillguard Top w/Flip-Top Surface and U-Base, LEFT**

GC3558LF	19 x 48 x 28-42	250	40	13.4	<b>\$2474</b>
GC3558LVF w/Vanity drawer	19 x 48 x 28-42	250	42	13.4	<b>\$2727</b>

- Dual vanity drawer with mirror slides out from either side of the table.

**Left** hand side table. Thermofoil top with seamless spillguard edge. One-hand activation flip-top provides a secondary surface with two cupholders, can hold up to 10 lbs. Height adjustable steel base. 1 per carton.

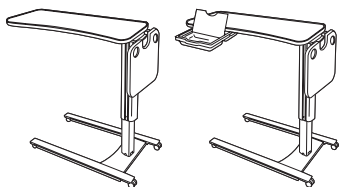

**Kidney Shaped Thermofoil Spillguard Top w/Flip-Top Surface and U-Base, RIGHT**

GC3558RF	19 x 48 x 28-42	250	40	13.4	<b>\$2474</b>
GC3558RVF w/Vanity drawer	19 x 48 x 28-42	250	42	13.4	<b>\$2727</b>

- Dual vanity drawer with mirror slides out from either side of the table.

**Right** hand side table. Thermofoil top with seamless spillguard edge. One-hand activation flip-top provides a secondary surface with two cupholders, can hold up to 10 lbs. Height adjustable steel base. 1 per carton.

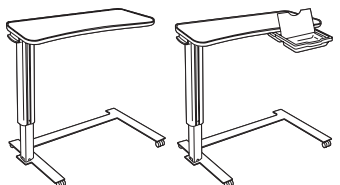

**Kidney Shaped Thermofoil Spillguard Top w/C Base - LEFT**

GC3559L	22 x 33 x 28-42	300	35	19	<b>\$1849</b>
GC3559LV w/Vanity drawer	22 x 33 x 28-42	300	37	19	<b>\$2102</b>

- Dual vanity drawer with mirror slides out from either side of the table.

**Left** hand side table. Thermofoil top with seamless spillguard edge. Height adjustable steel base. 1 per carton.

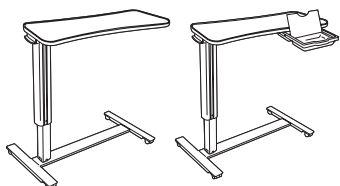

**Peanut Shaped Thermofoil Spillguard Top w/H Base**

GC3560	19 x 34 x 28-42	250	35	13.4	<b>\$1735</b>
GC3560V w/Vanity drawer	19 x 34 x 28-42	250	37	13.4	<b>\$1990</b>

- Dual vanity drawer with mirror slides out from either side of the table.

Thermofoil top with seamless spillguard edge. Height adjustable steel base. 1 per carton.

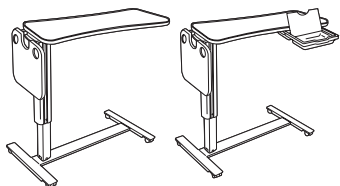

**Peanut Shaped Thermofoil Spillguard Top w/Flip-Top Surface and H Base**

GC3560F	48 x 19 x 28-42	250	40	13.4	<b>\$2559</b>
GC3560VF w/Vanity drawer	48 x 19 x 28-42	250	42	13.4	<b>\$2811</b>

- Dual vanity drawer with mirror slides out from either side of the table.

Thermofoil top with seamless spillguard edge. One-hand activation flip-top provides a secondary surface with two cupholders, can hold up to 10 lbs. Height adjustable steel base. 1 per carton.

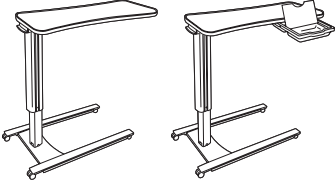
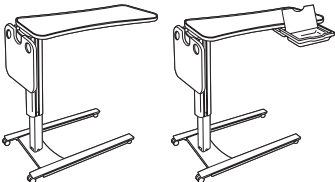
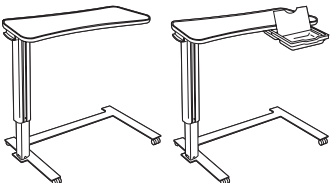
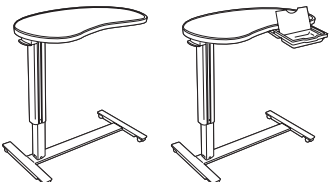
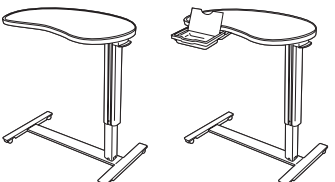
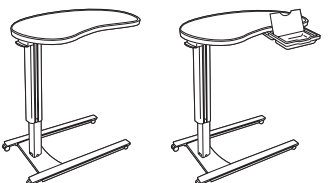
OVERBED TABLES	MODEL#	DIMENSIONS	FREIGHT CLASS	WT/LBS.	CUBIC FT.	LIST PRICE
 <p><b>Peanut Shaped Thermofoil Spillguard Top w/U Base</b></p>	GC3561	D x W x H 19 x 34 x 28-42	250	35	13.4	<b>\$1652</b>
	GC3561V w/Vanity drawer	19 x 34 x 28-42	250	37	13.4	<b>\$1905</b>
<ul style="list-style-type: none"> <li>• Dual vanity drawer with mirror slides out from either side of the table.</li> </ul> <p>Thermofoil top with seamless spillguard edge. Height adjustable steel base. 1 per carton.</p>						
 <p><b>Peanut Shaped Thermofoil Spillguard Top w/Flip-Top Surface and U Base</b></p>	GC3561F	19 x 48 x 28-42	250	40	13.4	<b>\$2474</b>
	GC3561VF w/Vanity drawer	19 x 48 x 28-42	250	42	13.4	<b>\$2727</b>
<ul style="list-style-type: none"> <li>• Dual vanity drawer with mirror slides out from either side of the table.</li> </ul> <p>Thermofoil top with seamless spillguard edge. One-hand activation flip-top provides a secondary surface with two cupholders, can hold up to 10 lbs. Height adjustable steel base. 1 per carton.</p>						
 <p><b>Peanut Shaped Thermofoil Spillguard Top w/C Base</b></p>	GC3562	22 x 33 x 28-42	300	35	19	<b>\$1849</b>
	GC3562V w/Vanity drawer	22 x 33 x 28-42	300	37	19	<b>\$2102</b>
<ul style="list-style-type: none"> <li>• Dual vanity drawer with mirror slides out from either side of the table.</li> </ul> <p>Thermofoil top with seamless spillguard edge. Height adjustable steel base. 1 per carton.</p>						
 <p><b>Jellybean Shaped Thermofoil Spillguard Top w/H Base - LEFT</b></p>	GC3563L	22 x 35 x 28-42.5	250	35	13.4	<b>\$1966</b>
	GC3563LV w/Vanity drawer	22 x 35 x 28-42.5	250	37	13.4	<b>\$2219</b>
<ul style="list-style-type: none"> <li>• Dual vanity drawer with mirror slides out from either side of the table.</li> </ul> <p><b>Left</b> hand side table. Thermofoil top with seamless spillguard edge. Height adjustable steel base. 1 per carton.</p>						
 <p><b>Jellybean Shaped Thermofoil Spillguard Top w/H Base - RIGHT</b></p>	GC3563R	22 x 35 x 28-42.5	250	35	13.4	<b>\$1966</b>
	GC3563RV w/Vanity drawer	22 x 35 x 28-42.5	250	37	13.4	<b>\$2219</b>
<ul style="list-style-type: none"> <li>• Dual vanity drawer with mirror slides out from either side of the table.</li> </ul> <p><b>Right</b> hand side table. Thermofoil top with seamless spillguard edge. Height adjustable steel base. 1 per carton.</p>						
 <p><b>Jellybean Shaped Thermofoil Spillguard Top w/U Base - LEFT</b></p>	GC3564L	22 x 36 x 28-42.5	250	35	13.4	<b>\$1882</b>
	GC3564LV w/Vanity drawer	22 x 36 x 28-42.5	250	37	13.4	<b>\$2135</b>
<ul style="list-style-type: none"> <li>• Dual vanity drawer with mirror slides out from either side of the table.</li> </ul> <p><b>Left</b> hand side table. Thermofoil top with seamless spillguard edge. Height adjustable steel base. 1 per carton.</p>						

# 0 OVERBED TABLES

## OVERBED TABLES

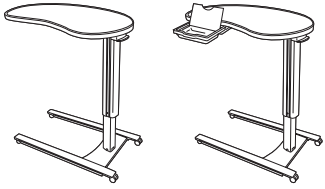

**Jellybean Shaped Thermofoil Spillguard Top w/U Base - RIGHT**

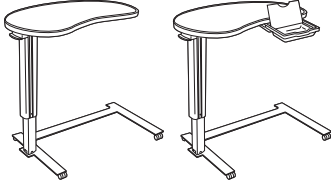

**Jellybean Shaped Thermofoil Spillguard Top w/C Base - LEFT**

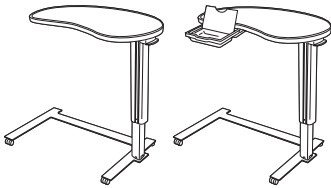

**Jellybean Shaped Thermofoil Spillguard Top w/C Base - RIGHT**

MODEL#	DIMENSIONS	FREIGHT CLASS	WT/LBS.	CUBIC FT.	LIST PRICE
--------	------------	---------------	---------	-----------	------------

D x W x H

GC3564R	22 x 36 x 28-42.5	250	35	13.4	<b>\$1882</b>
---------	-------------------	-----	----	------	---------------

GC3564RV w/Vanity drawer	22 x 36 x 28-42.5	250	37	13.4	<b>\$2135</b>
-----------------------------	-------------------	-----	----	------	---------------

- Dual vanity drawer with mirror slides out from either side of the table.

**Right** hand side table. Thermofoil top with seamless spillguard edge. Height adjustable steel base. 1 per carton.

GC3565L	22 x 36 x 28-42.5	300	35	19	<b>\$2078</b>
---------	-------------------	-----	----	----	---------------

GC3565LV w/Vanity drawer	22 x 36 x 28-42.5	300	37	19	<b>\$2333</b>
-----------------------------	-------------------	-----	----	----	---------------

- Dual vanity drawer with mirror slides out from either side of the table.

**Left** hand side table. Thermofoil top with seamless spillguard edge. Height adjustable steel base. 1 per carton.

GC3565R	22 x 36 x 28-42.5	300	35	19	<b>\$2078</b>
---------	-------------------	-----	----	----	---------------

GC3565RV w/Vanity drawer	22 x 36 x 28-42.5	300	37	19	<b>\$2333</b>
-----------------------------	-------------------	-----	----	----	---------------

- Dual vanity drawer with mirror slides out from either side of the table.

**Right** hand side table. Thermofoil top with seamless spillguard edge. Height adjustable steel base. 1 per carton.

ACCESSORIES

MODEL# DIMENSIONS FREIGHT CLASS WT/LBS. CUBIC FT. LIST PRICE



Storage Basket

D x W x H						
GC3566	6 x 10 x 9	150	2	0.4		<b>\$256</b>

Storage basket hooks on either side of the integrated accessory rail of the overbed table. 1 per carton.

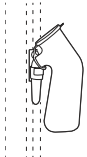

Urinal Hook

GC3567	--	70	1	0.01		<b>\$87</b>
--------	----	----	---	------	--	-------------

Hooks on either side of the integrated accessory rail of the overbed table. Bottle not included. 1 per carton.



Locking Casters

GC3568-UPCH	--	250	2	1		<b>\$42</b>
-------------	----	-----	---	---	--	-------------

Price is for 1.



Notes: Please specify all substitutions and options.

- Primacare table legs complement and work seamlessly with Primacare seating.
- Solid wood legs and apron.
- All connections are metal-to-metal inserts and fasteners.
- Shipped easy to assemble.
- 2mm edging color coordinated with laminate finish is standard for all tops. Finish must specified at time of order.
- Tops are 1" thick and available thermally fused laminate (**LP**) and high pressure laminate (**HP**). Please select the appropriate model number for the finish you prefer.
- Refer to the following lists when selecting a finish color. Must specify both a top color and leg finish at time of order.

#### Wood Legs

Absolute (AAM)  
Charcoal Java (CJM)  
Cherry (ACM)  
Empire Mahogany (EMM)  
English Oak (EOM)  
Espresso Cafe (ECM)  
Fruitwood (TFM)  
Gray (HGM)  
Harvest Oak (HOM)  
Honey (AHM)  
Jet Onyx (JOM)  
Light Honey (LHM)  
Mahogany (TMM)  
Maple (AVM)  
Medium Walnut (MWM)  
Natural Walnut (NLW)  
Night (ASM)  
Noce Biondo (NBM)  
Noce Grigio (NGM)  
Noce Leggero (NEM)  
Noce Medio (NMM)  
Sandy Beach (SBM)  
Shaker Cherry (SKM)  
Silver Oak (SOM)  
Walnut (TWM)  
White (WHM)  
WC Cream (WTM)  
Winter Cherry (WCM)

#### Thermally Fused Laminate (LP) Tops

Absolute Acajou (ACJ)  
Asian Night (ASN)  
Avant Cherry (AWC)  
Avant Honey (AWH)  
Brushed Cobalt (BRC)  
Clear Maple (CMB)  
Dark Espresso (DES)  
Designer White (DWT)  
Hayden Grey (HGT)  
Noce Biondo (NBL)  
Noce Grigio (NGL)  
Noce Leggero (NEL)  
Noce Medio (NML)  
Quartered Mahogany (QTM)  
Tiger Fruitwood (TFW)  
Tiger Walnut (TWL)  
Walnut Heights (WHE)  
White Chocolate (WHC)  
Winter Cherry (WCR)

#### High Pressure Laminate (HP) Tops

Absolute Acajou (ACJ)  
Asian Night (ASN)  
Avant Cherry (W357)  
Avant Honey (W356)  
Brushed Cobalt (BRC)  
Clear Maple (CMB)  
Dark Espresso (W142)  
Designer White (DWT)  
Hayden Grey (HGT)  
Noce Biondo (NBL)  
Noce Grigio (NGL)  
Noce Leggero (NEL)  
Noce Medio (NML)  
Quartered Mahogany (QTM)  
Tiger Fruitwood (TFW)  
Tiger Walnut (W819)  
Walnut Heights (WHE)  
White Chocolate (WHC)  
Winter Cherry (WCR)

#### PRIMACARE TABLES

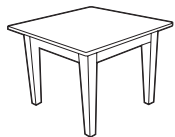

**Square End Table**

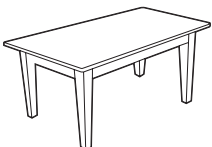

**Rectangular Coffee Table**

MODEL#	DIMENSIONS	FREIGHT CLASS	WT/LBS.	CUBIC FT.	LIST PRICE
GC3664-LP	22 x 22 x 17	250	22	6.75	<b>\$1194</b>
GC3664-HP	22 x 22 x 17	250	22	6.75	<b>\$1286</b>

- For a thermally fused top (LP), specify model GC3664-LP.
- For a high pressure laminate top, specify model GC3664-HP.
- Power and data can be added on the surface of the table. Order power/data module GC36410, see page 202.

Coordinating edge and solid wood frame. 1 per carton.

GC3665-LP	42 x 21 x 15	250	35	11	<b>\$1533</b>
GC3665-HP	42 x 21 x 15	250	35	11	<b>\$1656</b>

- For a thermally fused top (LP), specify model GC3665-LP.
- For a high pressure laminate top, specify model GC3665-HP.
- Power and data can be added on the surface of the table. Order power/data module GC36410, see page 202.

Coordinating edge and solid wood frame.

Notes: Please specify all substitutions and options.

- Primacare table legs complement the lines of design to work seamlessly with Primacare seating.
- Legs are metal with laminate skirt.
- All connections are metal-to-metal inserts and fasteners.
- Thermofoil and solid surface material options are available on request, please contact your Global sales representative for a special quotation.
- Shipped easy to assemble.
- 2mm edging color coordinated with laminate finish is standard for all tops. Finish must be specified at time of order.
- Tops are 1" thick and available in thermally fused laminate (LP) and high pressure laminate (HP). Please select the appropriate model number for the finish you prefer.
- Refer to the following lists when selecting a finish color. Must specify both a top color and leg finish at time of order.

**Metal Legs**

- Black (BLK)
- Latte (LAB)
- Kalua (KAL)
- Mocha (J52)
- Shadow (SHW)
- Toast (TOA)
- Tungsten (TUN)

**Thermally Fused Laminate (LP) Tops**

- Absolute Acajou (ACJ)
- Asian Night (ASN)
- Avant Cherry (AWC)
- Avant Honey (AWH)
- Brushed Cobalt (BRC)
- Clear Maple (CMB)
- Dark Espresso (DES)
- Designer White (DWT)
- Hayden Grey (HGT)
- Noce Biondo (NBL)
- Noce Grigio (NGL)
- Noce Leggero (NEL)
- Noce Medio (NML)
- Quartered Mahogany (QTM)
- Tiger Fruitwood (TFW)
- Tiger Walnut (TWL)
- Walnut Heights (WHE)
- White Chocolate (WHC)
- Winter Cherry (WCR)

**High Pressure Laminate (HP) Tops**

- Absolute Acajou (ACJ)
- Asian Night (ASN)
- Avant Cherry (W357)
- Avant Honey (W356)
- Brushed Cobalt (BRC)
- Clear Maple (CMB)
- Dark Espresso (W142)
- Designer White (DWT)
- Hayden Grey (HGT)
- Noce Biondo (NBL)
- Noce Grigio (NGL)
- Noce Leggero (NEL)
- Noce Medio (NML)
- Quartered Mahogany (QTM)
- Tiger Fruitwood (TFW)
- Tiger Walnut (W819)
- Walnut Heights (WHE)
- White Chocolate (WHC)
- Winter Cherry (WCR)

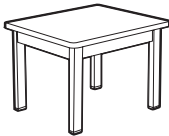
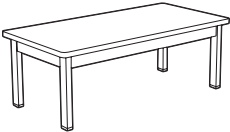
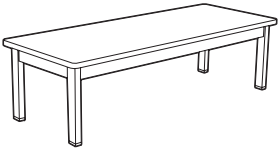
PRIMACARE HT TABLES	MODEL#	DIMENSIONS	FREIGHT CLASS	WT/LBS.	CUBIC FT.	LIST PRICE
	GC3661-LP	20 x 24 x 17	250	35	10.5	<b>\$1160</b>
	GC3661-HP	20 x 24 x 17	250	35	10.5	<b>\$1283</b>
<ul style="list-style-type: none"> <li>• For a thermally fused top (LP), specify model GC3661-LP.</li> <li>• For a high pressure laminate top, specify model GC3661-HP.</li> <li>• Power and data can be added on the surface of the table. Order power/data module GC36410, see page 202.</li> </ul>						
<p>Coordinating edge. 1.25" x 2" rectangular metal frame.</p>						
	GC3662-LP	21 x 42 x 15	250	52	14	<b>\$1472</b>
	GC3662-HP	21 x 42 x 15	250	52	14	<b>\$1631</b>
<ul style="list-style-type: none"> <li>• For a thermally fused top (LP), specify model GC3662-LP.</li> <li>• For a high pressure laminate top, specify model GC3662-HP.</li> <li>• Power and data can be added on the surface of the table. Order power/data module GC36410, see page 202.</li> </ul>						
<p>Coordinating edge. 1.25" x 2" rectangular metal frame.</p>						
	GC3663-LP	54 x 21 x 15	250	58	17.5	<b>\$1803</b>
	GC3663-HP	54 x 21 x 15	250	58	17.5	<b>\$1982</b>
<ul style="list-style-type: none"> <li>• For a thermally fused top (LP), specify model GC3662-LP.</li> <li>• For a high pressure laminate top, specify model GC3662-HP.</li> <li>• Power and data can be added on the surface of the table. Order power/data module GC36410, see page 202.</li> </ul>						
<p>Coordinating edge. 1.25" x 2" rectangular metal frame.</p>						

**NOTES****D x W x H**

- Four on the floor stability. Heavy duty steel legs are available in Black (**BLK**), Shadow (**SHW**), Toast (**TOA**), Storm Grey (**SOG**) and Tungsten (**TUN**). Please specify leg finish color when placing order. Latte (**LAB**), Mocha (**J52**), and Kalua (**KAL**) are also available by special request.
- Shipped RTA (ready to assemble).
- Adjustable 1.5" range Black plastic glides are standard. EXCEPT Tungsten (TUN) which has Tungsten glides.
- 3mm edging color coordinated with laminate finish is standard for all tops. Finish **MUST BE** specified at the time of order.
- Tablet Tables are designed to accept the tablet on all sides.
- Please specify all substitutions and options.
- 1" thick tops are available in thermally fused laminate (L) and high pressure laminate (H). Please select the appropriate model number for the finish you prefer.
- Refer to the following lists when selecting a finish color. **MUST** Specify both a Top Color and Leg Finish when ordering.
- For custom laminate or contrasting edge, please contact your Global sales representative for special quotation.

**Thermally Fused Laminate (L)**

Absolute Acajou (ACJ)  
 Asian Night (ASN)  
 Avant Cherry (AWC)  
 Avant Honey (AWH)  
 Brushed Cobalt (BRC)  
 Clear Maple (CMB)  
 Dark Espresso (DES)  
 Designer White (DWT)  
 Hayden Grey (HGT)  
 Quartered Mahogany (QTM)  
 Tiger Fruitwood (TFW)  
 Tiger Walnut (TWL)  
 Walnut Heights (WHE)  
 White Chocolate (WHC)  
 Winter Cherry (WCR)

**High Pressure Laminate (H)**

Absolute Acajou (ACJ)  
 Asian Night (ASN)  
 Avant Cherry (W357)  
 Avant Honey (W356)  
 Brushed Cobalt (BRC)  
 Clear Maple (CMB)  
 Dark Espresso (W142)  
 Designer White (DWT)  
 Hayden Grey (HGT)  
 Quartered Mahogany (QTM)  
 Tiger Fruitwood (TFW)  
 Tiger Walnut (W819)  
 Walnut Heights (WHE)  
 White Chocolate (WHC)  
 Winter Cherry (WCR)



Dining Table - 36"



Dining Table - 42"



Tablet

MODEL#	DIMENSIONS	FREIGHT CLASS	WT/LBS.	CUBIC FT.	LIST PRICE
--------	------------	---------------	---------	-----------	------------

GC3-36L	36 x 36 x 29	70	63.4	3.68	<b>\$1086</b>
GC3-36LH	36 x 36 x 29	70	63.4	3.68	<b>\$1275</b>

- For a thermally fused top (L), specify model GC3-36L.
- For a high pressure laminate top (H), specify model GC3-36LH.

Standard Black edge. 36" x 36" top accepts a tablet on all sides. Heavy duty steel legs are standard in Black Gloss (BLK). A variety of optional finishes are also available. Please Specify.

- Additional leg heights are available. Special quote is required.
- 2 cartons

GC3-42L	42 x 42 x 29	70	79.65	4.2	<b>\$1404</b>
GC3-42LH	42 x 42 x 29	70	79.65	4.2	<b>\$1623</b>

- For a thermally fused top (L), specify model GC3-42L.
- For a high pressure laminate top (H), specify model GC3-42LH.

Standard Black edge. 42" x 42" top accepts a tablet on all sides. Heavy duty steel legs are standard in Black Gloss (BLK). A variety of optional finishes are also available. Please Specify.

- Additional leg heights are available. Special quote is required.
- 2 cartons

GC3-NUG	10 x 24 x 1	70	15	0.8	<b>\$454</b>
GC3-NUGH	10 x 24 x 1	70	15	0.8	<b>\$494</b>

- For a thermally fused top (L), specify model GC3-NUG.
- For a high pressure laminate top (H), specify model GC3-NUGH.

Attachable tablet for above Table Tables. Attaches on any side to extend table by 24". Heavy duty steel mounting bracket is standard in Black.

# seating

## Private + Public + Individual + Group Applications

Application guidelines.....	61	GC Citi.....	125
Adeline.....	62	GC Comet.....	126
Aubra.....	64	GC Islands.....	127
Bishop.....	69	GC Sidero.....	128
Calidon.....	70	GC Sirena.....	138
Coast.....	77	GC Vion.....	140
Desmond.....	78	GC Wind.....	142
Desmond HT.....	79	Janna.....	144
Doctor Buddy.....	81	Nourish.....	145
Dreme.....	82	Primacare.....	149
Erin.....	85	River+.....	215
Flap.....	87	Senator.....	216
Foot Activated Stools.....	89	Sleep-Eez.....	217
Frolick.....	90	Splash.....	90
Gala II.....	95	Strand.....	218
GC Beach.....	96	Wingback.....	225
GC Belong.....	97		

SERIES	WOOD	METAL	BARIATRIC SEATING	DINING / CAFETERIA	GUEST SEATING	LOBBIES	LOUNGE / WAITING	OFFICE / MEETING	PATIENT ROOMS	RESIDENT ROOMS	STACKING	TREATMENT / EXAM ROOMS
ADELINE		•			•	•	•		•	•		•
AUBRA		•	•		•	•	•		•	•		•
BISHOP	•					•	•			•		
CALIDON	•		•		•	•	•		•	•		•
COAST	•						•		•	•		
DESMOND	•			•	•	•	•	•	•	•		
DESMOND HT		•	•	•	•	•	•	•	•	•		
DOCTOR BUDDY		•		•				•	•	•		•
DREME									•	•		
ERIN	•	•		•	•	•	•		•	•		
FLAP				•	•						•	•
FOOT ACTIVATED STOOLS				•				•	•	•		•
FROLICK		•	•	•	•	•	•	•	•	•	•	•
GALA II		•						•				•
GC BEACH	•			•	•	•	•	•	•	•		
GC BELONG		•	•		•	•	•		•	•		•
GC CITI		•			•	•	•					
GC COMET	•	•	•	•	•	•	•	•	•	•	•	•
GC ISLANDS	•			•	•	•	•	•	•	•		
GC SIDERO		•	•	•	•	•	•	•	•	•	•	•
GC SIRENA	•			•	•	•	•	•	•	•		
GC VION								•				
GC WIND		•				•	•	•	•	•		
JANNA	•			•	•		•	•	•	•		•
NOURISH		•	•				•		•	•		•
OTTOMANS	•	•			•	•	•		•	•		•
PRIMACARE	•		•	•	•	•	•		•	•		•
PRIMACARE HT		•	•	•	•	•	•		•	•		•
PRIMACARE MODULAR	•		•	•	•	•	•					
PRIMACARE WINGBACK	•	•	•		•	•	•		•	•		
SENATOR	•	•				•	•		•	•		
SLEEP-EEZ					•				•	•		
SPLASH		•		•	•	•	•	•	•	•	•	•
STRAND	•	•	•		•	•	•		•	•		•
THROW PILLOWS						•	•			•		
WINGBACK	•				•	•	•		•	•		

**ADELINE**



model **GC7680**

**STANDARD FEATURES**



- Flex back moves with the user, providing comfort and support while seated.
- Sleek oval tube steel frame is available in Black (BLK), Shadow (SHW), Toast (TOA), Tungsten (TUN), Latte (LAB), Mocha (J52), and Kalua (KAL). Please specify.
- Self-skinned urethane armcaps are available in Black (BLK), Shadow (SHW), Toast (TOA), Latte (LAB), Mocha (J52), and Kalua (KAL). Please Specify.
- Standard seat height on all models is 18". For 20" seat height, see (-20) models.
- For Globalcare textiles and finish options, visit the website at [globalfurnituregroup.com](http://globalfurnituregroup.com)
- For added comfort, seats are standard with high density Ultracell foam.
- Standard glide is plastic.
- Shipped fully assembled

**OPTIONAL FEATURES**

- For hard surface floors, please specify opaque non-marking glides (**NM**). No upcharge
- To add sealed seams to your product, contact customer care for more information.
- For moisture barrier on seat, please specify (**MB**). Add \$119.

**SUGGESTED APPLICATIONS**

- Guest seating
- Lobbies
- Lounge/Waiting
- Patient rooms
- Resident rooms
- Treatment/Exam rooms

DESCRIPTION	MODEL#	STANDARD FABRIC GRADES											
		COM	2	3	4	5	6	7	8	9	10	11	12
 <p><b>Curved High Flex Back Armchair</b> COM Yardage: 2 Freight Class: 250 Product Weight (lbs.): 40 Cubic Feet Per Carton: 20</p> <p>Active weight 300 lbs.</p>	<b>GC7680</b>	\$1625	\$1650	\$1783	\$1857	\$1965	\$2003	\$2097	\$2273	\$2363	\$2524	\$2752	\$3035
	<b>GC7680-20</b> 20" seat height	\$1692	\$1753	\$1894	\$1973	\$2088	\$2131	\$2230	\$2421	\$2516	\$2691	\$2935	\$3235
	<b>OVERALL DIMENSIONS</b>			<b>SEAT DIMENSIONS</b>			<b>BACK DIMENSIONS</b>						
	<b>W</b>	<b>D</b>	<b>H</b>	<b>W</b>	<b>D</b>	<b>H</b>	<b>W</b>	<b>H</b>					
25.5	28	45	19.5	18	18	18	27						
25.5	28	47	19.5	18	20	18	30						
 <p><b>Curved High Fixed Back Armchair</b> COM Yardage: 2 Freight Class: 250 Product Weight (lbs.): 46 Cubic Feet Per Carton: 20</p> <p>Active weight 300 lbs.</p>	<b>GC7681</b>	\$1668	\$1729	\$1872	\$1949	\$2064	\$2107	\$2208	\$2398	\$2492	\$2665	\$2910	\$3211
	<b>GC7681-20</b> 20" seat height	\$1766	\$1828	\$1973	\$2053	\$2167	\$2212	\$2312	\$2501	\$2596	\$2771	\$3014	\$3317
	<b>OVERALL DIMENSIONS</b>			<b>SEAT DIMENSIONS</b>			<b>BACK DIMENSIONS</b>						
	<b>W</b>	<b>D</b>	<b>H</b>	<b>W</b>	<b>D</b>	<b>H</b>	<b>W</b>	<b>H</b>					
25.5	28	45	19.5	18	18	18	27						
25.5	28	47	19.5	18	20	18	30						
 <p><b>Curved Low Flex Back Armchair</b> COM Yardage: 1.75 Freight Class: 250 Product Weight (lbs.): 42 Cubic Feet Per Carton: 20</p> <p>Active weight 300 lbs.</p>	<b>GC7682</b>	\$1533	\$1589	\$1635	\$1703	\$1798	\$1833	\$1917	\$2076	\$2154	\$2302	\$2505	\$2754
	<b>GC7682-20</b> 20" seat height	\$1631	\$1687	\$1733	\$1801	\$1897	\$1931	\$2015	\$2174	\$2252	\$2400	\$2603	\$2853
	<b>OVERALL DIMENSIONS</b>			<b>SEAT DIMENSIONS</b>			<b>BACK DIMENSIONS</b>						
	<b>W</b>	<b>D</b>	<b>H</b>	<b>W</b>	<b>D</b>	<b>H</b>	<b>W</b>	<b>H</b>					
25.5	28	40	19.5	18	18	18	22						
25.5	28	42	19.5	18	18	18	22						

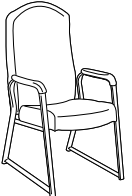
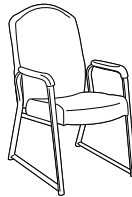
DESCRIPTION	MODEL#	STANDARD FABRIC GRADES											
		COM	2	3	4	5	6	7	8	9	10	11	12
 <p><b>Curved Low Fixed Back Armchair</b>                      COM Yardage: 1.75                      Freight Class: 250                      Product Weight (lbs.): 44                      Cubic Feet Per Carton: 20</p>	<b>GC7683</b>	\$1609	\$1663	\$1709	\$1778	\$1873	\$1908	\$1993	\$2150	\$2228	\$2377	\$2579	\$2829
	<b>GC7683-20</b> 20" seat height	\$1707	\$1761	\$1807	\$1876	\$1971	\$2007	\$2091	\$2249	\$2328	\$2475	\$2678	\$2927
		<b>OVERALL DIMENSIONS</b>			<b>SEAT DIMENSIONS</b>			<b>BACK DIMENSIONS</b>					
	Active weight 300 lbs.	<b>W</b>	<b>D</b>	<b>H</b>	<b>W</b>	<b>D</b>	<b>H</b>	<b>W</b>	<b>H</b>				
	25.5	28	40	19.5	18	18	18	22					
	25.5	28	42	19.5	18	20	18	22					
 <p><b>Curved High Flex Back Armchair, Sled Base</b>                      COM Yardage: 2                      Freight Class: 250                      Product Weight (lbs.): 46                      Cubic Feet Per Carton: 20</p>	<b>GC7684</b>	\$1692	\$1753	\$1806	\$1884	\$1993	\$2035	\$2129	\$2310	\$2400	\$2568	\$2799	\$3085
		<b>OVERALL DIMENSIONS</b>			<b>SEAT DIMENSIONS</b>			<b>BACK DIMENSIONS</b>					
	Active weight 300 lbs.	<b>W</b>	<b>D</b>	<b>H</b>	<b>W</b>	<b>D</b>	<b>H</b>	<b>W</b>	<b>H</b>				
		25.5	28	45	19.5	18	18	18	27				
 <p><b>Curved Low Flex Back Armchair7693, Sled Base</b>                      COM Yardage: 2                      Freight Class: 250                      Product Weight (lbs.): 46                      Cubic Feet Per Carton: 20</p>	<b>GC7685</b>	\$1668	\$1729	\$1872	\$1949	\$2064	\$2107	\$2208	\$2398	\$2492	\$2665	\$2910	\$3211
		<b>OVERALL DIMENSIONS</b>			<b>SEAT DIMENSIONS</b>			<b>BACK DIMENSIONS</b>					
	Active weight 300 lbs.	<b>W</b>	<b>D</b>	<b>H</b>	<b>W</b>	<b>D</b>	<b>H</b>	<b>W</b>	<b>H</b>				
		25.5	28	40	19.5	18	18	18	22				



DESCRIPTION MODEL# STANDARD FABRIC GRADES

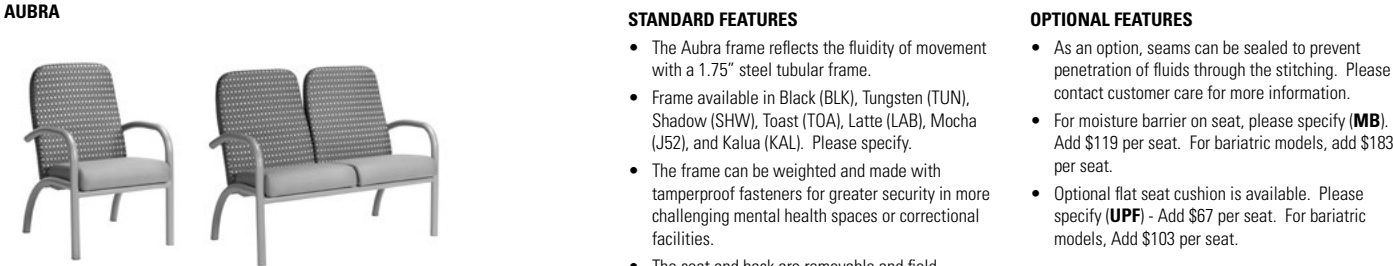

model GC4181HB model GC4182HB

STANDARD FEATURES

- The Aubra frame reflects the fluidity of movement with a 1.75" steel tubular frame.
- Frame available in Black (BLK), Tungsten (TUN), Shadow (SHW), Toast (TOA), Latte (LAB), Mocha (J52), and Kalua (KAL). Please specify.
- The frame can be weighted and made with tamperproof fasteners for greater security in more challenging mental health spaces or correctional facilities.
- The seat and back are removable and field replaceable.
- For added comfort, seats are standard with high density Ultracell foam and seat cushion is slightly inclined.
- All seat frames feature a wallsaver design to prevent back contact with wall. Ottomans and Benches **do not** have wallsaver legs.
- Standard seat height on all models is 18.5"
- Table heights are 16", ottoman heights are 12"
- Clean out space is provided between the seat and back cushions for easier housekeeping.
- Non-marking glides suitable for hard surface floors (including linoleum) are standard
- Active weight capacity for standard single seat is 350 lbs. and 750 lbs. for bariatric seating.
- For Globalcare textiles and finish options, visit the website at [www.globalfurnituregroup.com](http://www.globalfurnituregroup.com)
- Can be upholstered in standard Global textiles if healthcare compliance is not required.
- **Left and Right Position Reference** is determined based on being seated in the chair.

OPTIONAL FEATURES

- As an option, seams can be sealed to prevent penetration of fluids through the stitching. Please contact customer care for more information.
- For moisture barrier on seat, please specify **(MB)**. Add \$119 per seat. For bariatric models, add \$183 per seat.
- Optional flat seat cushion is available. Please specify **(UPF)** - Add \$67 per seat. For bariatric models, Add \$103 per seat.

SUGGESTED APPLICATIONS

- Bariatric seating
- Guest seating
- Lobbies
- Lounge/Waiting
- Patient rooms
- Resident rooms
- Treatment/Exam rooms

For Aubra tables, see page 66.

DESCRIPTION MODEL# STANDARD FABRIC GRADES

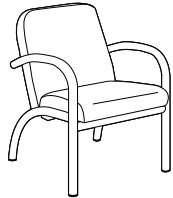

MODEL#	COM	2	3	4	5	6	7	8	9	10	11	12
GC4181	\$1229	\$1283	\$1329	\$1397	\$1493	\$1528	\$1611	\$1770	\$1850	\$1996	\$2199	\$2449

OVERALL DIMENSIONS			SEAT DIMENSIONS			BACK DIMENSIONS	
W	D	H	W	D	H	W	H
24.5	27.5	35	21	18	18	21	17

**Low Back Single Seat Armchair**  
 COM Yardage: 1.75  
 Freight Class: 250  
 Product Weight (lbs.): 44  
 Cubic Feet Per Carton: 17.5

Active weight 350 lbs.

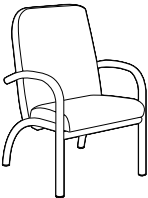

MODEL#	COM	2	3	4	5	6	7	8	9	10	11	12
GC4181HB	\$1304	\$1364	\$1420	\$1497	\$1606	\$1648	\$1742	\$1924	\$2014	\$2180	\$2412	\$2698

OVERALL DIMENSIONS			SEAT DIMENSIONS			BACK DIMENSIONS	
W	D	H	W	D	H	W	H
24.5	27.5	39	21	18	18	21	21

**High Back Single Seat Armchair**  
 COM Yardage: 2  
 Freight Class: 250  
 Product Weight (lbs.): 48  
 Cubic Feet Per Carton: 20

Active weight 350 lbs.

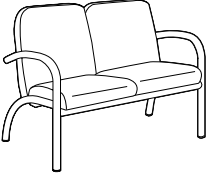
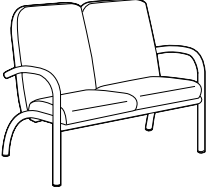
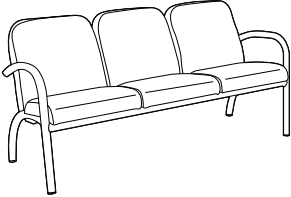
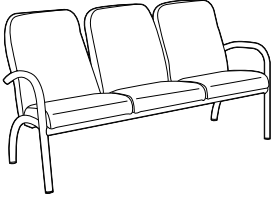
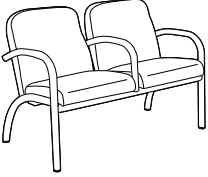
DESCRIPTION	MODEL#	STANDARD FABRIC GRADES											
		COM	2	3	4	5	6	7	8	9	10	11	12
 <p><b>Low Back Two Seat Chair</b> No Center Arm COM Yardage: 3.25 Freight Class: 300 Product Weight (lbs.): 75 Cubic Feet Per Carton: 43</p>	<b>GC4182</b>	\$1859	\$1961	\$2047	\$2172	\$2351	\$2417	\$2573	\$2866	\$3010	\$3282	\$3660	\$4125
		<b>OVERALL DIMENSIONS</b>			<b>SEAT DIMENSIONS</b>			<b>BACK DIMENSIONS</b>					
		W	D	H	W	D	H	W	H				
		Active weight 350 lbs./seat.	46.5	27.5	35	43	18	18	43	17			
 <p><b>High Back Two Seat Chair</b> No Center Arm COM Yardage: 3.5 Freight Class: 300 Product Weight (lbs.): 80 Cubic Feet Per Carton: 53.75</p>	<b>GC4182HB</b>	\$2008	\$2119	\$2211	\$2346	\$2537	\$2610	\$2774	\$3092	\$3247	\$3541	\$3948	\$4449
		<b>OVERALL DIMENSIONS</b>			<b>SEAT DIMENSIONS</b>			<b>BACK DIMENSIONS</b>					
		W	D	H	W	D	H	W	H				
		Active weight 350 lbs./seat.	46.5	27.5	39	43	18	18	43	21			
 <p><b>Low Back Three Seat Chair</b> No Center Arm COM Yardage: 4.75 Freight Class: 300 Product Weight (lbs.): 100 Cubic Feet Per Carton: 60</p>	<b>GC4183</b>	\$2703	\$2854	\$2979	\$3163	\$3422	\$3519	\$3746	\$4174	\$4386	\$4784	\$5336	\$6018
		<b>OVERALL DIMENSIONS</b>			<b>SEAT DIMENSIONS</b>			<b>BACK DIMENSIONS</b>					
		W	D	H	W	D	H	W	H				
		Active weight 350 lbs./seat.	68.5	27.5	35	65	18	18	65	17			
 <p><b>High Back Three Seat Chair</b> No Center Arm COM Yardage: 5.25 Freight Class: 300 Product Weight (lbs.): 106 Cubic Feet Per Carton: 75</p>	<b>GC4183HB</b>	\$2929	\$3096	\$3232	\$3435	\$3721	\$3831	\$4082	\$4552	\$4790	\$5228	\$5837	\$6590
		<b>OVERALL DIMENSIONS</b>			<b>SEAT DIMENSIONS</b>			<b>BACK DIMENSIONS</b>					
		W	D	H	W	D	H	W	H				
		Active weight 350 lbs./seat.	68.5	27.5	39	65	18	18	65	21			
 <p><b>Low Back Two Seat Chair</b> Half Center Arm COM Yardage: 3.25 Freight Class: 300 Product Weight (lbs.): 80 Cubic Feet Per Carton: 43</p>	<b>GC4184</b>	\$2027	\$2129	\$2214	\$2339	\$2519	\$2585	\$2741	\$3032	\$3178	\$3450	\$3828	\$4293
		<b>OVERALL DIMENSIONS</b>			<b>SEAT DIMENSIONS</b>			<b>BACK DIMENSIONS</b>					
		W	D	H	W	D	H	W	H				
		Active weight 350 lbs./seat.	47.75	27.5	35	21.5	18	18	21.5	17			

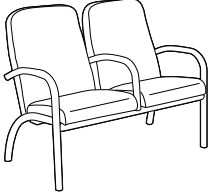
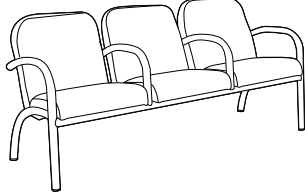
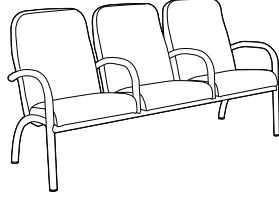
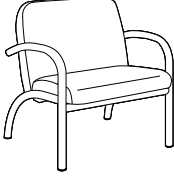
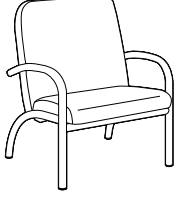
DESCRIPTION	MODEL#	STANDARD FABRIC GRADES											
		COM	2	3	4	5	6	7	8	9	10	11	12
 <p><b>High Back Two Seat Chair</b> Half Center Arm COM Yardage: 3.5 Freight Class: 300 Product Weight (lbs.): 85 Cubic Feet Per Carton: 53.75</p>	GC4184HB	\$2177	\$2289	\$2381	\$2515	\$2707	\$2779	\$2948	\$3262	\$3417	\$3711	\$4117	\$4619
		OVERALL DIMENSIONS			SEAT DIMENSIONS			BACK DIMENSIONS					
		W	D	H	W	D	H	W	H				
			47.75	27.5	39	21.5	18	18	21.5	21			
 <p><b>Low Back Three Seat Chair</b> Half Center Arms COM Yardage: 4.75 Freight Class: 300 Product Weight (lbs.): 106 Cubic Feet Per Carton: 60</p>	GC4185	\$3043	\$3194	\$3319	\$3502	\$3761	\$3859	\$4087	\$4514	\$4727	\$5124	\$5676	\$6356
		OVERALL DIMENSIONS			SEAT DIMENSIONS			BACK DIMENSIONS					
		W	D	H	W	D	H	W	H				
			70.75	27.5	35	21.5	18	18	21.5	17			
 <p><b>High Back Three Seat Chair</b> Half Center Arms COM Yardage: 5.25 Freight Class: 300 Product Weight (lbs.): 112 Cubic Feet Per Carton: 75</p>	GC4185HB	\$3269	\$3435	\$3575	\$3776	\$4061	\$4170	\$4421	\$4893	\$5129	\$5568	\$6177	\$6929
		OVERALL DIMENSIONS			SEAT DIMENSIONS			BACK DIMENSIONS					
		W	D	H	W	D	H	W	H				
			70.75	27.5	39	21.5	18	18	21.5	21			
 <p><b>Bariatric Low Back Armchair</b> COM Yardage: 3.25 Freight Class: 250 Product Weight (lbs.): 64 Cubic Feet Per Carton: 26.5</p>	GC4186	\$1493	\$1597	\$1683	\$1808	\$1987	\$2053	\$2209	\$2500	\$2646	\$2918	\$3296	\$3760
		OVERALL DIMENSIONS			SEAT DIMENSIONS			BACK DIMENSIONS					
		W	D	H	W	D	H	W	H				
			35.5	27.5	35	32	18	18	32	17			
 <p><b>Bariatric High Back Armchair</b> COM Yardage: 3.5 Freight Class: 250 Product Weight (lbs.): 68 Cubic Feet Per Carton: 30.5</p>	GC4186HB	\$1571	\$1683	\$1775	\$1908	\$2100	\$2173	\$2338	\$2654	\$2811	\$3105	\$3510	\$4012
		OVERALL DIMENSIONS			SEAT DIMENSIONS			BACK DIMENSIONS					
		W	D	H	W	D	H	W	H				
			35.5	27.5	39	32	18	18	32	21			

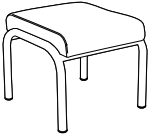
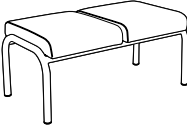
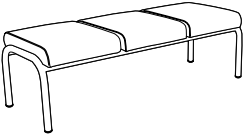
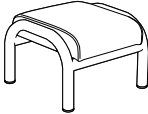
DESCRIPTION	MODEL#	STANDARD FABRIC GRADES											
		COM	2	3	4	5	6	7	8	9	10	11	12
  <b>Single Seat Bench</b> COM Yardage: 1.25 Freight Class: 250 Product Weight (lbs.): 28 Cubic Feet Per Carton: 8.5	GC4187	\$958	\$996	\$1030	\$1078	\$1147	\$1176	\$1234	\$1345	\$1404	\$1506	\$1654	\$1831
		<b>OVERALL DIMENSIONS</b>			<b>SEAT DIMENSIONS</b>			<b>BACK DIMENSIONS</b>					
		W	D	H	W	D	H	W	H				
			24.5	24	18	21	--	18					
  <b>Two Seat Bench</b> COM Yardage: 2 Freight Class: 250 Product Weight (lbs.): 50 Cubic Feet Per Carton: 23	GC4188	\$1382	\$1443	\$1496	\$1574	\$1682	\$1724	\$1819	\$2000	\$2090	\$2257	\$2489	\$2775
		<b>OVERALL DIMENSIONS</b>			<b>SEAT DIMENSIONS</b>			<b>BACK DIMENSIONS</b>					
		W	D	H	W	D	H	W	H				
			46.5	24	18	21	--	18					
  <b>Three Seat Bench</b> COM Yardage: 2.25 Freight Class: 250 Product Weight (lbs.): 78 Cubic Feet Per Carton: 33.25	GC4189	\$1819	\$1887	\$1949	\$2033	\$2157	\$2203	\$2310	\$2513	\$2615	\$2803	\$3064	\$3381
		<b>OVERALL DIMENSIONS</b>			<b>SEAT DIMENSIONS</b>			<b>BACK DIMENSIONS</b>					
		W	D	H	W	D	H	W	H				
			68.5	24	18	21	--	18					
  <b>Angled Top Ottoman</b> COM Yardage: 1 Freight Class: 150 Product Weight (lbs.): 20 Cubic Feet Per Carton: 3.5	GC4190	\$806	\$836	\$864	\$902	\$958	\$979	\$1026	\$1116	\$1161	\$1245	\$1360	\$1503
		<b>OVERALL DIMENSIONS</b>			<b>SEAT DIMENSIONS</b>			<b>BACK DIMENSIONS</b>					
		W	D	H	W	D	H	W	H				
			18	18	18	18	--	12.5					
			Active weight 350 lbs.										
			Stores beneath any standard seating unit.										

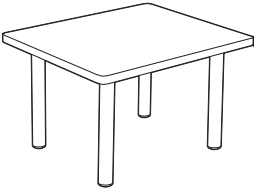
TABLES	MODEL#	DIMENSIONS D x W x H	FREIGHT CLASS	WT/LBS.	CUBIC FT.	LIST PRICE
	GC4191-LP	22 x 26 x 16	100	25	3.1	<b>\$820</b>
	GC4191-HP	22 x 26 x 16	100	25	3.1	<b>\$936</b>

**Rectangular End Table**

- For a thermally fused laminate top (LP), specify model GC4191-LP
- For a high pressure laminate top (HP), specify model GC4191-HP.

1" thick top with coordinating 3mm edge and 1 3/4" dia. steel tubular legs

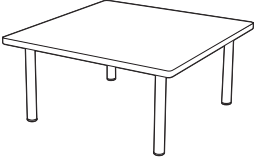
	GC4192-LP	34 x 34 x 16	125	46	6	<b>\$1007</b>
	GC4192-HP	34 x 34 x 16	125	46	6	<b>\$1205</b>

**Corner Table Square**

- For a thermally fused laminate top (LP), specify model GC4192-LP.
- For a high pressure laminate top (HP), specify model GC4192-HP.

1" thick top with coordinating 3mm edge and 1 3/4" dia. steel tubular legs

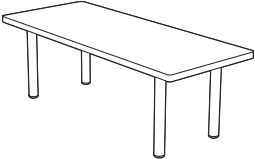
	GC4193-LP	20 x 48 x 16	125	37	5.75	<b>\$955</b>
	GC4193-HP	20 x 48 x 16	125	37	5.75	<b>\$1138</b>

**Coffee Table Rectangular**

- For a thermally fused laminate top (LP), specify model GC4193-LP.
- For a high pressure laminate top (HP), specify model GC4193-HP.

1" thick top with coordinating 3mm edge and 1 3/4" dia. steel tubular legs

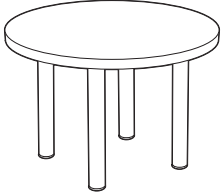
	GC4194-LP	24 x 24 x 16	125	25	3.4	<b>\$796</b>
	GC4194-HP	24 x 24 x 16	125	25	3.4	<b>\$869</b>

**24" Round Table**

- For a thermally fused laminate top (LP), specify model GC4194-LP.
- For a high pressure laminate top (HP), specify model GC4194-HP.

1" thick top with coordinating 3mm edge and 1 3/4" dia. steel tubular legs

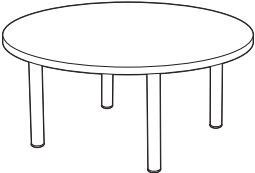
	GC4195-LP	36 x 36 x 16	125	42	6	<b>\$971</b>
	GC4195-HP	36 x 36 x 16	125	42	6	<b>\$1047</b>

**36" Round Table**

- For a thermally fused laminate top (LP), specify model GC4194-LP.
- For a high pressure laminate top (HP), specify model GC4194-HP.

1" thick top with coordinating 3mm edge and 1 3/4" dia. steel tubular legs

BISHOP



model GC3751

STANDARD FEATURES

- Bishop offers a classic, traditional, rolled arm style design.
- Features removable and replaceable seat cushions
- Wood frame and hardwood block legs are available in a variety of finishes: erry (ACM), English Oak (EOM), Espresso Cafe (ECM), Fruitwood (TFM), Honey (AHM), Mahogany (TMM), Maple (AVM), Natural Walnut (NLW), Noce Biondo (NBM), Noce Grigio (NGM), Noce Leggero (NEM), Noce Medio (NMM), Sandy Beach (SKM), and Walnut (TWM). Please specify.
- For added comfort, seat and back are standard with high density Ultracell foam.
- Opaque non-marking glides are standard
- For Globalcare textiles and finish options, visit the website at [globalfurnituregroup.com](http://globalfurnituregroup.com)
- Can be upholstered in standard Global textiles if healthcare compliance is not required.
- Shipped fully assembled.
- Standard glide is plastic.

OPTIONAL FEATURES

- For non-slip glides, specify **(NS)**. Add \$32
- For moisture barrier on seat, please specify **(MB)**. Add \$178 per seat.

SUGGESTED APPLICATIONS

- Lobbies
- Lounge/Waiting
- Resident rooms

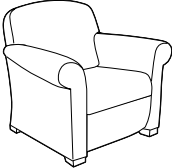
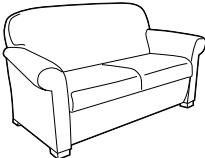
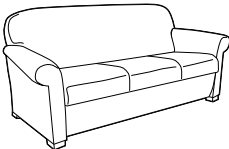
DESCRIPTION	MODEL#	STANDARD FABRIC GRADES											
		COM	2	3	4	5	6	7	8	9	10	11	12
  <b>Lounge Chair</b> COM Yardage: 7.25 Freight Class: 250 Product Weight (lbs.): 75 Cubic Feet Per Carton: 30.25	GC3751	\$2400	\$2632	\$2821	\$3100	\$3496	\$3645	\$3994	\$4643	\$4970	\$5576	\$6418	\$7457
		OVERALL DIMENSIONS			SEAT DIMENSIONS			BACK DIMENSIONS					
		W	D	H	W	D	H	W	H				
			37	32	34.5	21	18.5	17	28	17.5			
Active weight 300 lbs. Loose seat cushion.													
  <b>Two Seat Sofa</b> COM Yardage: 8.75 Freight Class: 250 Product Weight (lbs.): 112 Cubic Feet Per Carton: 55.75	GC3752	\$3391	\$3670	\$3897	\$4235	\$4714	\$4894	\$5312	\$6099	\$6493	\$7224	\$8238	\$9493
		OVERALL DIMENSIONS			SEAT DIMENSIONS			BACK DIMENSIONS					
		W	D	H	W	D	H	W	H				
			63.5	32	34.5	47.5	18.5	17	55	17.5			
Active weight 300 lbs./seat. Loose seat cushions.													
  <b>Three Seat Sofa</b> COM Yardage: 12 Freight Class: 250 Product Weight (lbs.): 155 Cubic Feet Per Carton: 74.75	GC3753	\$5014	\$5355	\$5916	\$6369	\$7010	\$7252	\$7815	\$8870	\$9397	\$10380	\$11745	\$13431
		OVERALL DIMENSIONS			SEAT DIMENSIONS			BACK DIMENSIONS					
		W	D	H	W	D	H	W	H				
			90	32	34.5	74	18.5	17	82	17.5			
Active weight 300 lbs./seat. Loose seat cushions.													

CALIDON



**GC36305**  
Wood Lounge Single Seat, Open Arms



**GC36301**  
Wood Guest Single Seat, Open Arms



**GC36308**  
Wood Lounge Single Seat, Closed Arms



For Calidon tables, see 74.

EXAMPLE CALIDON ORDER CODE:

GC36308	PU75	AAM	NBS
Model #	Textile	Frame Finish	Sealed Back Seams

NSS	NB	NM	SRT
Sealed Seat Seams	Moisture Barrier	Glides	Power

POWER LOCATION DIAGRAM

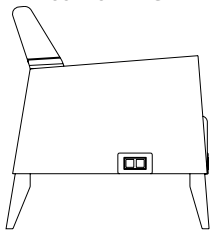

Right Side Power (SRT)  
Models GC36308, GC36309 and GC36310

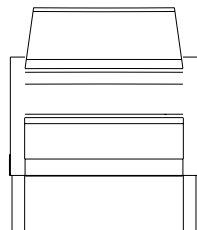

Front Power Not Available  
Model GC36308

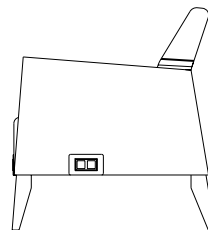

Left Side Power (SLT)  
Models GC36308, GC36309 and GC36310

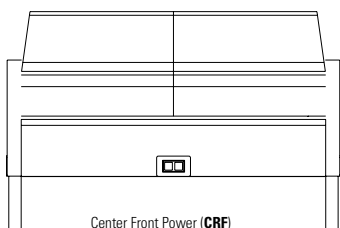

Center Front Power (CRF)  
Model GC36309 only

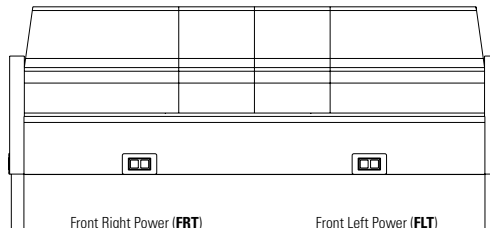

Front Right Power (FRT)  
Model GC36310 only

Front Left Power (FLT)  
Model GC36310 only

STANDARD FEATURES

- Calidon series consists of wood frame guest, lounge, bariatric and bench seating. Freestanding and tandem/bridge tables also available to complement the line.
- Calidon is designed for the rigors of high use environments. Lounge units include metal frame supports.
- Frame design features a wall saver leg to prevent back contact and damage to walls.
- All guest and lounge chairs feature a clean out between seat and back, replaceable seat cushions and tall legs for ease of cleaning.
- Lounge chairs with closed arms are fully upholstered.
- For added comfort, seats are standard with high density Ultracell foam.
- Active weight capacity up to 400 lbs/seat for standard seating; up to 600 lbs for bariatric seating.
- For healthcare textiles, visit the website at [globalfurnituregroup.com](http://globalfurnituregroup.com).
- Textiles with a minimum of 100,000 double rubs must be specified to meet Global's 24/7 warranty coverage.
- Can be upholstered in standard Global textiles if Healthcare 24/7 warranty compliance is not required.

OPTIONAL FEATURES

- Guest chair models can be specified with urethane or Corian armcaps, securely fastened with metal-to-metal connectors, allowing for field replacement if required. Armcaps cannot be retrofitted in the field on units with no existing armcaps.
- Lounge seating with closed arms can be specified with a tamperproof power/USB unit, which includes one AC outlet, two 10 watt USB ports, and a 10 ft long, three-prong power cord. The power unit is black with matching face plate and cord. Power is factory installed and must be specified at time of order. Add \$219 each. Power locations vary by model. See power location diagram.
- For moisture barrier on seat, specify (MB). Upcharges vary, see model.
- To add sealed seams, specify (SBS) for seat back and arms and/or (SSS) for seat. Upcharges vary, see model.
- A tamperproof power unit is available to specify in various locations on closed arm lounge models only. See diagrams.

Please add option codes in the following order:

- **Model number**  
**GC36301 to GC36303** Guest chairs  
**GC36304** Bariatric guest chair  
**GC36305 to GC36307** Lounge, open arms  
**GC36308 to GC36310** Lounge, closed arms  
**GC36311 to GC36313** Benches  
**GC36318 to GC36321** Tandem/bridge tables  
 For Calidon tables, refer to 74.
- **Textile**  
Specify textile code.
- **Armcap option** (guest chairs only)  
**(FNA)** No armcaps  
**(FAC)** With armcaps. Upcharges vary, see model.
- **Frame finish**  

<b>(AAM)</b> Absolute	<b>(MWM)</b> Medium Walnut
<b>(CJM)</b> Charcoal Java	<b>(ASM)</b> Night
<b>(ACM)</b> Cherry	<b>(NBM)</b> Noce Biondo
<b>(EMM)</b> Empire Mahogany	<b>(NGM)</b> Noce Grigio
<b>(EOM)</b> English Oak	<b>(NEM)</b> Noce Leggero
<b>(ECM)</b> Espresso Cafe	<b>(NMM)</b> Noce Medio
<b>(TFM)</b> Fruitwood	<b>(SBM)</b> Sandy Beach
<b>(HGM)</b> Grey	<b>(SKM)</b> Shaker Cherry
<b>(HOM)</b> Harvest Oak	<b>(SOM)</b> Silver Oak
<b>(AHM)</b> Honey	<b>(TWM)</b> Walnut
<b>(JOM)</b> Jet Onyx	<b>(WTM)</b> WC Cream
<b>(LHM)</b> Light Honey	<b>(WHM)</b> White
<b>(TMM)</b> Mahogany	<b>(WCM)</b> Winter Cherry
<b>(AVM)</b> Maple	
- **Armcap finish** (guest chairs only with **FAC**)  
**(SSU)** Self-skinned urethane armcaps. Upcharges vary, see model.  
**(BLK)** Black  
**(KAL)** Kalua  
**(LAB)** Latte  
**(J52)** Mocha  
**(SHW)** Shadow  
**(TOA)** Toast  
**(GO)** Solid Surface. Upcharges vary, see model.  
**(GWH)** Glacier White
- **Sealed Back Seams**  
**(NBS)** No sealed back seams  
**(SBS)** Sealed back seams. Upcharges vary, see model.
- **Sealed Seat Seams**  
**(NSS)** No sealed seat seams  
**(SSS)** Sealed seat seams. Upcharges vary, see model.
- **Glides**  
**(NM)** Non-marking  
**(NS)** Non-slip  
 Guest single seat, bariatric and lounge chairs, add \$26.  
 Guest two seater, Add \$40.  
 Guest three seater, add \$51.
- **Moisture Barrier** (seat only)  
**(NB)** No moisture barrier  
**(MB)** Moisture barrier. Upcharges vary, see model.
- **Power/USB unit position** (closed arm, lounge models only). Add \$219.  
**(NPM)** No power  
**(TPM)** Tamperproof power unit  
**(J)** Black  
**(SRT)** Side right  
**(SLT)** Side left  
**(FLT)** Front left (three seater only)  
**(FRT)** Front right (three seater only)  
**(CRF)** Center front (two seater only)  
**(SLR)** Side left and right. Add \$437.  
**(FLR)** Front left and right. Add \$437.

SUGGESTED APPLICATIONS

- Guest seating
- Lobby/Lounge
- Treatment/Exam rooms

# SEATING

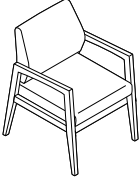
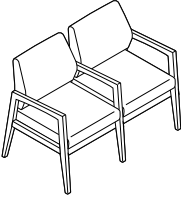
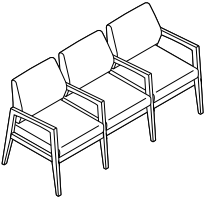
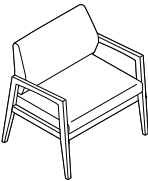
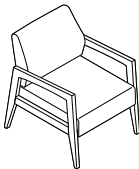
DESCRIPTION	MODEL#	STANDARD FABRIC GRADES											
		1/COM	2	3	4	5	6	7	8	9	10	11	12
 <p><b>Wood Guest Single Seat, Open Arms</b> COM Yardage: 1.9 Freight Class: 250 Product Weight (lbs.): 38 Cubic Feet Per Carton: 16.5</p> <p>Add \$419 for Corian® armcaps Add \$117 for SSU armcaps Add \$116 for <b>(MB)</b> Add \$25 for <b>(SSS)</b>, \$35 for <b>(SBS)</b></p>	<b>GC36301</b>	\$1106	\$1167	\$1215	\$1285	\$1384	\$1426	\$1511	\$1646	\$1747	\$1857	\$2087	\$2328
	Active weight 400 lbs.	<b>OVERALL DIMENSIONS</b>			<b>SEAT DIMENSIONS</b>			<b>BACK DIMENSIONS</b>					
		<b>W</b>	<b>D</b>	<b>H</b>	<b>W</b>	<b>D</b>	<b>H</b>	<b>W</b>	<b>H</b>				
		23.5	26.5	34.5	21.5	18	18	21.5	16.5				
 <p><b>Wood Guest Two Seater, Full Center Arm, Open Arms</b> COM Yardage: 3.8 Freight Class: 250 Product Weight (lbs.): 68 Cubic Feet Per Carton: 31.75</p> <p>Add \$627 for Corian® armcaps Add \$175 for SSU armcaps Add \$231 for <b>(MB)</b> Add \$49 for <b>(SSS)</b>, \$69 for <b>(SBS)</b></p>	<b>GC36302</b>	\$2047	\$2169	\$2264	\$2405	\$2602	\$2686	\$2857	\$3127	\$3328	\$3548	\$4008	\$4491
	Active weight 400 lbs./seat	<b>OVERALL DIMENSIONS</b>			<b>SEAT DIMENSIONS</b>			<b>BACK DIMENSIONS</b>					
		<b>W</b>	<b>D</b>	<b>H</b>	<b>W</b>	<b>D</b>	<b>H</b>	<b>W</b>	<b>H</b>				
		46	26.5	34.5	21.5	18	18	21.5	16.5				
 <p><b>Wood Guest Three Seater, Full Center Arms, Open Arms</b> COM Yardage: 5.7 Freight Class: 250 Product Weight (lbs.): 101 Cubic Feet Per Carton: 47.5</p> <p>Add \$836 for Corian® armcaps Add \$234 for SSU armcaps Add \$345 for <b>(MB)</b> Add \$73 for <b>(SSS)</b>, \$103 for <b>(SBS)</b></p>	<b>GC36303</b>	\$3013	\$3196	\$3338	\$3549	\$3846	\$3971	\$4228	\$4632	\$4934	\$5265	\$5955	\$6679
	Active weight 400 lbs./seat	<b>OVERALL DIMENSIONS</b>			<b>SEAT DIMENSIONS</b>			<b>BACK DIMENSIONS</b>					
		<b>W</b>	<b>D</b>	<b>H</b>	<b>W</b>	<b>D</b>	<b>H</b>	<b>W</b>	<b>H</b>				
		68	26.5	34.5	21.5	18	18	21.5	16.5				
 <p><b>Wood Guest Bariatric Chair, Open Arms</b> COM Yardage: 2.5 Freight Class: 250 Product Weight (lbs.): 55 Cubic Feet Per Carton: 22.25</p> <p>Add \$836 for Corian® armcaps Add \$234 for SSU armcaps Add \$173 for <b>(MB)</b> Add \$25 for <b>(SSS)</b>, \$40 for <b>(SBS)</b></p>	<b>GC36304</b>	\$1691	\$1771	\$1835	\$1927	\$2057	\$2111	\$2225	\$2401	\$2535	\$2679	\$2981	\$3299
	Active weight 600 lbs.	<b>OVERALL DIMENSIONS</b>			<b>SEAT DIMENSIONS</b>			<b>BACK DIMENSIONS</b>					
		<b>W</b>	<b>D</b>	<b>H</b>	<b>W</b>	<b>D</b>	<b>H</b>	<b>W</b>	<b>H</b>				
		32.75	26.5	34.5	31	18	18	30.5	16.5				
 <p><b>Wood Lounge Single Seat, Open Arms</b> COM Yardage: 2.5 Freight Class: 250 Product Weight (lbs.): 49 Cubic Feet Per Carton: 18.25</p> <p>Add \$116 for <b>(MB)</b> Add \$30 for <b>(SSS)</b>, \$41 for <b>(SBS)</b></p>	<b>GC36305</b>	\$1546	\$1626	\$1690	\$1782	\$1912	\$1966	\$2080	\$2256	\$2390	\$2534	\$2836	\$3154
	Active weight 400 lbs.	<b>OVERALL DIMENSIONS</b>			<b>SEAT DIMENSIONS</b>			<b>BACK DIMENSIONS</b>					
		<b>W</b>	<b>D</b>	<b>H</b>	<b>W</b>	<b>D</b>	<b>H</b>	<b>W</b>	<b>H</b>				
		25.75	29.5	32.5	24	21	16	23.5	16.5				

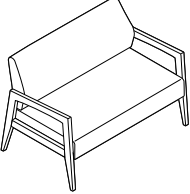
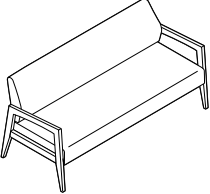
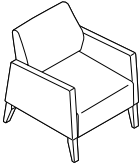
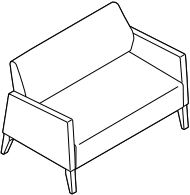
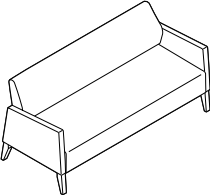

DESCRIPTION	MODEL#	STANDARD FABRIC GRADES											
		1/COM	2	3	4	5	6	7	8	9	10	11	12
 <p><b>Wood Lounge Two Seater, Open Arms</b> COM Yardage: 4 Freight Class: 250 Product Weight (lbs.): 77 Cubic Feet Per Carton: 32.75</p>	<p>GC36306</p> <p>Active weight 400 lbs./seat</p> <p>Add \$231 for (MB) Add \$44 for (SSS), \$58 for (SBS)</p>	\$2174	\$2302	\$2403	\$2551	\$2759	\$2846	\$3027	\$3310	\$3523	\$3755	\$4238	\$4747
		OVERALL DIMENSIONS			SEAT DIMENSIONS			BACK DIMENSIONS					
		W	D	H	W	D	H	W	H				
		47.5	29.5	32.5	45	21	16	44.5	16.5				
 <p><b>Wood Lounge Three Seater, Open Arms</b> COM Yardage: 5.25 Freight Class: 250 Product Weight (lbs.): 109 Cubic Feet Per Carton: 50.75</p>	<p>GC36307</p> <p>Active weight 400 lbs./seat</p> <p>Add \$345 for (MB) Add \$58 for (SSS), \$74 for (SBS)</p>	\$2718	\$2886	\$3018	\$3212	\$3485	\$3600	\$3837	\$4209	\$4488	\$4793	\$5427	\$6095
		OVERALL DIMENSIONS			SEAT DIMENSIONS			BACK DIMENSIONS					
		W	D	H	W	D	H	W	H				
		70.5	29.5	32.5	68	21	16	67.5	16.5				
 <p><b>Wood Lounge Single Seat, Closed Arms</b> COM Yardage: 4 Freight Class: 250 Product Weight (lbs.): 58 Cubic Feet Per Carton: 18.75</p>	<p>GC36308</p> <p>Active weight 400 lbs.</p> <p>Add \$116 for (MB) Add \$33 for (SSS), \$132 for (SBS) Power/USB unit available.</p>	\$1752	\$1880	\$1981	\$2129	\$2337	\$2424	\$2605	\$2888	\$3101	\$3333	\$3816	\$4325
		OVERALL DIMENSIONS			SEAT DIMENSIONS			BACK DIMENSIONS					
		W	D	H	W	D	H	W	H				
		27.5	29.5	33.5	24	21	16	23.5	17.5				
 <p><b>Wood Lounge Two Seater, Closed Arms</b> COM Yardage: 5.75 Freight Class: 250 Product Weight (lbs.): 89 Cubic Feet Per Carton: 33.75</p>	<p>GC36309</p> <p>Active weight 400 lbs./seat</p> <p>Add \$231 for (MB) Add \$48 for (SSS), \$148 for (SBS) Power/USB unit available.</p>	\$2356	\$2540	\$2685	\$2897	\$3196	\$3322	\$3582	\$3989	\$4295	\$4628	\$5323	\$6054
		OVERALL DIMENSIONS			SEAT DIMENSIONS			BACK DIMENSIONS					
		W	D	H	W	D	H	W	H				
		49.5	29.5	33.5	44.5	18	16	45.5	17.5				
 <p><b>Wood Lounge Three Seater, Closed Arms</b> COM Yardage: 7 Freight Class: 250 Product Weight (lbs.): 123 Cubic Feet Per Carton: 52</p>	<p>GC36310</p> <p>Active weight 400 lbs./seat</p> <p>Add \$345 for (MB) Add \$61 for (SSS), \$165 for (SBS) Power/USB unit available.</p>	\$2959	\$3183	\$3359	\$3618	\$3982	\$4135	\$4451	\$4947	\$5319	\$5725	\$6571	\$7461
		OVERALL DIMENSIONS			SEAT DIMENSIONS			BACK DIMENSIONS					
		W	D	H	W	D	H	W	H				
		71.5	29.5	33.5	66.5	18	16	67.5	17.5				

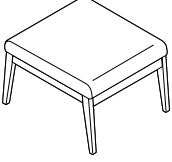
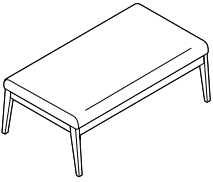
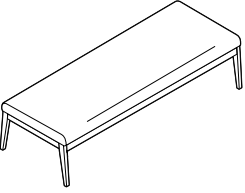
DESCRIPTION	MODEL#	STANDARD FABRIC GRADES											
		1/COM	2	3	4	5	6	7	8	9	10	11	12
 <p><b>Single Seat Bench</b> COM Yardage: 1 Freight Class: 150 Product Weight (lbs.): 41 Cubic Feet Per Carton: 10</p>	<b>GC36311</b>	<b>\$1184</b>	<b>\$1216</b>	<b>\$1241</b>	<b>\$1278</b>	<b>\$1330</b>	<b>\$1352</b>	<b>\$1397</b>	<b>\$1468</b>	<b>\$1521</b>	<b>\$1579</b>	<b>\$1700</b>	<b>\$1827</b>
	Active weight 400 lbs.	<b>OVERALL DIMENSIONS</b>			<b>SEAT DIMENSIONS</b>			<b>BACK DIMENSIONS</b>					
		<b>W</b>	<b>D</b>	<b>H</b>	<b>W</b>	<b>D</b>	<b>H</b>	<b>W</b>	<b>H</b>				
		24	28	18	24	26.75	18						
		Add \$116 for <b>(MB)</b>		Add \$28 for <b>(SSS)</b>									
 <p><b>Two Seat Bench</b> COM Yardage: 2 Freight Class: 250 Product Weight (lbs.): 61 Cubic Feet Per Carton: 18.75</p>	<b>GC36312</b>	<b>\$1873</b>	<b>\$1937</b>	<b>\$1987</b>	<b>\$2061</b>	<b>\$2165</b>	<b>\$2209</b>	<b>\$2299</b>	<b>\$2441</b>	<b>\$2547</b>	<b>\$2663</b>	<b>\$2905</b>	<b>\$3159</b>
	Active weight 400 lbs./seat	<b>OVERALL DIMENSIONS</b>			<b>SEAT DIMENSIONS</b>			<b>BACK DIMENSIONS</b>					
		<b>W</b>	<b>D</b>	<b>H</b>	<b>W</b>	<b>D</b>	<b>H</b>	<b>W</b>	<b>H</b>				
		48	28	18	48	26.75	18						
		Add \$231 for <b>(MB)</b>		Add \$56 for <b>(SSS)</b>									
 <p><b>Three Seat Bench</b> COM Yardage: 3 Freight Class: 250 Product Weight (lbs.): 97 Cubic Feet Per Carton: 27.75</p>	<b>GC36313</b>	<b>\$2235</b>	<b>\$2331</b>	<b>\$2406</b>	<b>\$2517</b>	<b>\$2673</b>	<b>\$2739</b>	<b>\$2874</b>	<b>\$3087</b>	<b>\$3246</b>	<b>\$3420</b>	<b>\$3783</b>	<b>\$4164</b>
	Active weight 400 lbs./seat	<b>OVERALL DIMENSIONS</b>			<b>SEAT DIMENSIONS</b>			<b>BACK DIMENSIONS</b>					
		<b>W</b>	<b>D</b>	<b>H</b>	<b>W</b>	<b>D</b>	<b>H</b>	<b>W</b>	<b>H</b>				
		72	28	18	72	26.75	18						
		Add \$345 for <b>(MB)</b>		Add \$82 for <b>(SSS)</b>									

CALIDON TABLES



Square end table - 22"  
GC36314



Rectangular Coffee Table  
GC36317



Tandem Side Table, Right  
GC36319R

EXAMPLE CALIDON TABLE ORDER CODE:

GC36319R	-HP	-ACJ	-CNT
Model #	Top material	Laminate finish	Power

TABLE STANDARD FEATURES

- A variety of wood leg tables are available. The wood legs/frames are specifiable in the same wood seating finishes.
- Table tops are 1" thick, available in thermally fused laminate (LP), high pressure laminate (HP), and Corian® solid surface (CO). Upcharges vary, see model for pricing.
- Laminate top tables include color coordinating vinyl edge band.
- Tandem/bridge table models (GC36318 to GC36321) connect to guest seating only and include ganging brackets.
- Tandem tables are specified left or right, as seated.

TABLE OPTIONAL FEATURES

- A tamperproof tabletop power unit may be specified on laminate top, tandem and square end tables only. Specify **CNT**. Add **\$331**. The power unit is located centered 1.5" from the edge of the surface. See power location diagrams for reference.

SUGGESTED APPLICATIONS

- Lounge/Lobby
- Patient rooms
- Resident rooms
- Private office

Please add option codes in the following order:

- **Table model number**  
**GC36314** to **GC36317** Freestanding tables  
**GC36318** to **GC36321** Tandem/bridge tables  
 For Calidon seating, refer to 70.
- **Top Material (tables)**  
**(LP)** Thermally fused laminate. Specify finish - See LP finishes.  
**(HP)** High pressure laminate. Upcharges vary - see model. Specify finish - see HP finishes.  
**(CO)** Solid surface. Upcharges vary - see model. Glacier White (**GWH**) finish only.
- **Leg finish**  
**(AAM)** Absolute  
**(CJM)** Charcoal Java  
**(ACM)** Cherry  
**(EMM)** Empire Mahogany  
**(EOM)** English Oak  
**(ECM)** Espresso Cafe  
**(TFM)** Fruitwood  
**(HGM)** Grey  
**(HOM)** Harvest Oak  
**(AHM)** Honey  
**(JOM)** Jet Onyx  
**(LHM)** Light Honey  
**(TMM)** Mahogany  
**(AVM)** Maple  
**(MWM)** Medium Walnut  
**(ASM)** Night  
**(NBM)** Noce Biondo  
**(NGM)** Noce Grigio  
**(NEM)** Noce Leggero  
**(NMM)** Noce Medio  
**(SBM)** Sandy Beach  
**(SKM)** Shaker Cherry  
**(SOM)** Silver Oak  
**(TWM)** Walnut  
**(WTM)** WC Cream  
**(WHM)** White  
**(WCM)** Winter Cherry
- **Power/USB unit position** (tandem and square side tables with laminate tops only).  
**(NPM)** No power  
**(CNT)** Center top power. Jet Black. Add **\$331**.

TABLE TOP FINISHES:

Thermally fused laminate (LP):

- |                       |                          |
|-----------------------|--------------------------|
| Absolute Acajou (ACJ) | Noce Biondo (NBL)        |
| Asian Night (ASN)     | Noce Grigio (NGL)        |
| Avant Cherry (AWC)    | Noce Leggero (NEL)       |
| Avant Honey (AWH)     | Noce Medio (NML)         |
| Black (BLK)           | Quartered Mahogany (QTM) |
| Brushed Cobalt (BRC)  | Tiger Fruitwood (TFW)    |
| Clear Maple (CMB)     | Tiger Walnut (TWL)       |
| Dark Espresso (DES)   | Walnut Heights (WHE)     |
| Designer White (DWT)  | White Chocolate (WHC)    |
| Hayden Grey (HGT)     | Winter Cherry (WCR)      |

High pressure laminate (HP):

- |                       |                          |
|-----------------------|--------------------------|
| Absolute Acajou (ACJ) | Noce Biondo (NBL)        |
| Asian Night (ASN)     | Noce Grigio (NGL)        |
| Avant Cherry (AWC)    | Noce Leggero (NEL)       |
| Avant Honey (AWH)     | Noce Medio (NML)         |
| Black (BLK)           | Quartered Mahogany (QTM) |
| Brushed Cobalt (BRC)  | Tiger Fruitwood (TFW)    |
| Clear Maple (CMB)     | Tiger Walnut (TWL)       |
| Dark Espresso (DES)   | Walnut Heights (WHE)     |
| Designer White (DWT)  | White Chocolate (WHC)    |
| Hayden Grey (HGT)     | Winter Cherry (WCR)      |

Corian Solid Surface (CO):

- Glacier White (GLW)

POWER LOCATION DIAGRAM

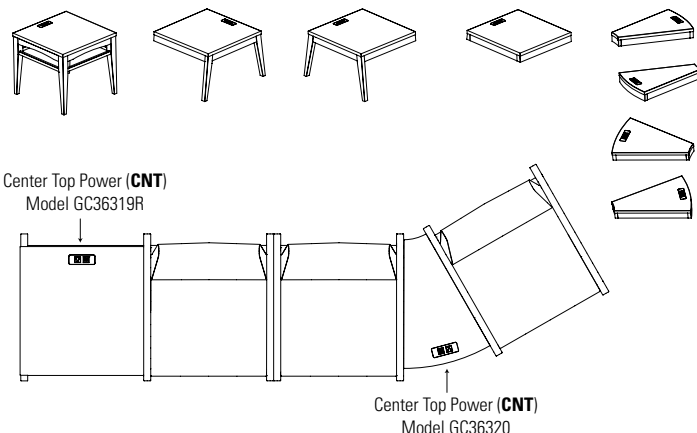

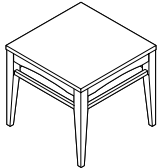
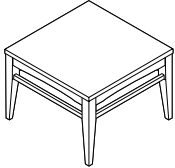
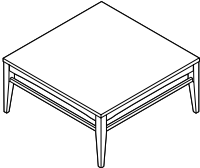
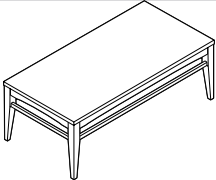
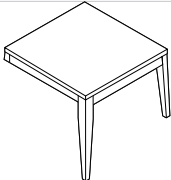
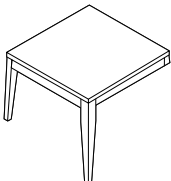
TABLES	MODEL#	DIMENSIONS	FREIGHT CLASS	WT/LBS.	CUBIC FT.	LIST PRICE
 <p><b>Square End Table - 22"</b></p>	GC36314	22 x 22 x 20.25	150	36	7.75	<b>\$764</b>
						<ul style="list-style-type: none"> <li>• Pricing shown for a thermally fused laminate top <b>(LP)</b>.</li> <li>• For a high pressure laminate top <b>(HP)</b>, add <b>\$60</b>.</li> <li>• For a Corian solid surface top <b>(CO)</b>, add <b>\$1120</b>.</li> </ul> <p>Coordinating edge on laminate surfaces with solid wood frame and legs. 1 per carton. Power/USB unit can be specified in the surface of laminate top tables <b>(CNT)</b>. Add <b>\$312</b>.</p>
 <p><b>Square Coffee Table - 24"</b></p>	GC36315	24 x 24 x 17.25	250	37	9.5	<b>\$793</b>
						<ul style="list-style-type: none"> <li>• Pricing shown for a thermally fused laminate top <b>(LP)</b>.</li> <li>• For a high pressure laminate top <b>(HP)</b>, add <b>\$60</b>.</li> <li>• For a Corian solid surface top <b>(CO)</b>, add <b>\$1270</b>.</li> </ul> <p>Coordinating edge on laminate surfaces with solid wood frame and legs. 1 per carton.</p>
 <p><b>Square Coffee Table - 36"</b></p>	GC36316	36 x 36 x 17.25	250	65	18.25	<b>\$949</b>
						<ul style="list-style-type: none"> <li>• Pricing shown for a thermally fused laminate top <b>(LP)</b>.</li> <li>• For a high pressure laminate top <b>(HP)</b>, add <b>\$129</b>.</li> <li>• For a Corian solid surface top <b>(CO)</b>, add <b>\$2859</b>.</li> </ul> <p>Coordinating edge on laminate surfaces with solid wood frame and legs. 1 per carton.</p>
 <p><b>Rectangular Coffee Table</b></p>	GC36317	24 x 48 x 17.25	250	56	16.5	<b>\$1039</b>
						<ul style="list-style-type: none"> <li>• Pricing shown for a thermally fused laminate top <b>(LP)</b>.</li> <li>• For a high pressure laminate top <b>(HP)</b>, add <b>\$117</b>.</li> <li>• For a Corian solid surface top <b>(CO)</b>, add <b>\$2575</b>.</li> </ul> <p>Coordinating edge on laminate surfaces with solid wood frame and legs. 1 per carton.</p>
 <p><b>Tandem Side Table, Left</b></p>	GC36319L	26.5 x 22.25 x 15.75	250	20	6.75	<b>\$662</b>
						<ul style="list-style-type: none"> <li>• Pricing shown for a thermally fused laminate top <b>(LP)</b>.</li> <li>• For a high pressure laminate top <b>(HP)</b>, add <b>\$60</b>.</li> <li>• For a Corian solid surface top <b>(CO)</b>, add <b>\$1207</b>.</li> </ul> <p>Coordinating edge on laminate surfaces with solid wood frame and legs. Must be connected to a guest chair. Includes one set of U-channel connectors and hardware. 1 per carton. Power/USB unit can be specified in the surface of laminate top tables <b>(CNT)</b>. Add <b>\$331</b>.</p>
 <p><b>Tandem Side Table, Right</b></p>	GC36319R	26.5 x 22.25 x 15.75	250	20	6.75	<b>\$662</b>
						<ul style="list-style-type: none"> <li>• Pricing shown for a thermally fused laminate top <b>(LP)</b>.</li> <li>• For a high pressure laminate top <b>(HP)</b>, add <b>\$60</b>.</li> <li>• For a Corian solid surface top <b>(CO)</b>, add <b>\$1207</b>.</li> </ul> <p>Coordinating edge on laminate surfaces with solid wood frame and legs. Must be connected to a guest chair. Includes one set of U-channel connectors and hardware. 1 per carton. Power/USB unit can be specified in the surface of laminate top tables <b>(CNT)</b>. Add <b>\$331</b>.</p>

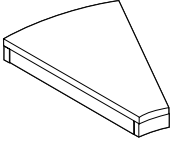
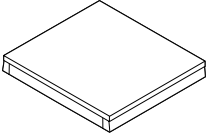
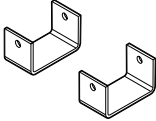
TABLES	MODEL#	DIMENSIONS	FREIGHT CLASS	WT/LBS.	CUBIC FT.	LIST PRICE
 <p><b>Corner Table, 30 Degree</b></p>	GC36320	22.5 x 15.75 x 3	92.5	16	1.5	<b>\$521</b>
			<ul style="list-style-type: none"> <li>• Pricing shown for a thermally fused laminate top (<b>LP</b>).</li> <li>• For a high pressure laminate top (<b>HP</b>), add <b>\$60</b>.</li> <li>• For a Corian solid surface top (<b>CO</b>), add <b>\$952</b>.</li> </ul> <p>Coordinating edge on laminate surfaces with solid wood frame and legs. Must be connected between two guest chairs. Includes two sets of U-channel connectors and hardware. 1 per carton. Power/USB unit can be specified in the surface of laminate top tables (<b>CNT</b>). Add <b>\$331</b>.</p>			
 <p><b>In-Line Table, Square</b></p>	GC36321	21 x 23.5 x 3	92.5	20	1.9	<b>\$552</b>
			<ul style="list-style-type: none"> <li>• Pricing shown for a thermally fused laminate top (<b>LP</b>).</li> <li>• For a high pressure laminate top (<b>HP</b>), add <b>\$60</b>.</li> <li>• For a Corian solid surface top (<b>CO</b>), add <b>\$1148</b>.</li> </ul> <p>Coordinating edge on laminate surfaces with solid wood frame and legs. Must be connected between two guest chairs. Includes two sets of U-channel connectors and hardware. 1 per carton. Power/USB unit can be specified in the surface of laminate top tables (<b>CNT</b>). Add <b>\$331</b>.</p>			
 <p><b>U-Channel (set of 2)</b></p>	GC36322	2.87 x 1.5 x 1.62	70	0.75	0.03	<b>\$44</b>
			Includes hardware. 4 sets per carton.			

COAST



Clean out space around seat cushions for easy housekeeping

model GC4172

EXAMPLE COAST ORDER CODE:

GC4172	-LX21	-SS	-ST	-	-
Model #	Textile	Armcaps	Glides	Moisture Barrier	Sealed Seams

STANDARD FEATURES

- The smooth low range glide adds relaxing motion while you sink back and coast in this ultra-comfortable chair.
- Adjustable non-marking glides are standard
- For added comfort, seats are standard with high density Ultracell foam.
- Cleanout space is provided between the seat and back cushions for easy housekeeping.
- Arms on the glider are fixed with a grip allowing the user to easily enter and exit from the chair. Combined with a smooth low-range motion mechanism, this eliminates the need for a locking mechanism
- Standard with Black self-skinned urethane (SSU) fully extended arms with a grip for ease of entry and exit from chair.
- Seamless front upholstery method on the seat cushion prevents eventual breakdown of seams causing liquid penetration into the foam.
- For Globalcare textiles and finish options, visit the website at [www.globalfurnituregroup.com](http://www.globalfurnituregroup.com)
- Can be upholstered in standard Global textiles only if healthcare compliance is not required.
- Shipped fully assembled.

OPTIONAL FEATURES

- For non-slip glides, please specify **(NS)**. Add **\$32**.
- To add sealed seams to your product, contact Customer Care. Upcharges vary
- For moisture barrier **(MB)** (Seat Only) - Add \$119 list upcharge.
- Tablet arm with spill collector on the edge is available, offered in Black Phenolic material. Tablet rotates so it can be positioned for any user activity and can fold down to store beside the chair when not being used. From seated position, specify **(LT)** for left hand tablet or **(RT)** for right hand tablet. Add **\$938**. For tablet on both sides, specify **(TB)**. Add **\$1874**.

SUGGESTED APPLICATIONS

- Patient rooms
- Resident rooms
- Lounge/Waiting

Please add option codes in the following order:

- **Model number**  
**GC4172** Glider/motion chair  
- Add **(33)** to model # if CAL133 is required.
- **Textile**  
Specify fabric code.
- **Armcap finish**  
**(SS)** Black SSU armcap  
**(LT)** Latte SSU armcap  
**(KL)** Kalua SSU armcap  
**(MA)** Mocha SSU armcap  
**(SW)** Shadow SSU armcap  
**(TO)** Toast SSU armcap  
**(AB)** Absolute wood armcap  
**(CJ)** Charcoal Java wood armcap  
**(AC)** Cherry wood armcap  
**(EP)** Empire Mahogany wood armcap  
**(EM)** English Oak wood armcap  
**(EC)** Espresso Cafe wood armcap  
**(HG)** Gray wood armcap  
**(HA)** Harvest Oak wood armcap  
**(AH)** Honey wood armcap  
**(JO)** Jet Onyx wood armcap  
**(LH)** Light Honey wood armcap  
**(AV)** Maple wood armcap  
**(MW)** Medium Walnut wood armcap  
**(NL)** Natural Walnut wood armcap  
**(AT)** Night wood armcap  
**(BI)** Noce Biondo wood armcap  
**(GI)** Noce Grigio wood armcap  
**(EI)** Noce Leggero wood armcap  
**(MI)** Noce Medio wood armcap  
**(SB)** Sandy Beach wood armcap  
**(SK)** Shaker Cherry wood armcap  
**(SM)** Silver Oak wood armcap  
**(TF)** Tiger Fruitwood wood armcap  
**(TM)** Tiger Mahogany wood armcap  
**(TL)** Tiger Walnut wood armcap  
**(WR)** WC Cream wood armcap  
**(WE)** White wood armcap  
**(WC)** Winter Cherry wood armcap
- **Glides**  
**(ST)** Adjustable non-marking glides  
**(NS)** Adjustable non-slip glides
- **Moisture Barrier**  
**(MB)** Seat only
- **Sealed seams**  
**(SS)** All sealed seams

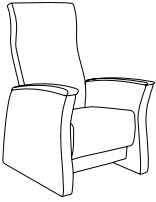
DESCRIPTION	MODEL#	STANDARD FABRIC GRADES											
		COM	2	3	4	5	6	7	8	9	10	11	12
 <p><b>Glider / Motion Chair</b> COM Yardage: 5.5 Freight Class: 250 Product Weight (lbs.): 115 Cubic Feet Per Carton: 29.5</p>	GC4172	\$2313	\$2474	\$2607	\$2802	\$3079	\$3210	\$3462	\$3863	\$4172	\$4515	\$5223	\$5976
		<p><b>OVERALL DIMENSIONS</b></p> <p>W D H</p>		<p><b>SEAT DIMENSIONS</b></p> <p>W D H</p>			<p><b>BACK DIMENSIONS</b></p> <p>W H</p>						
<p>Active weight 350 lbs.</p> <p>Specify armcap: wood or SSU.</p>		30	31.5	43.5	21.5	19.5	18	22	28				

**DESMOND**

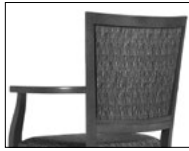

model GC4162

**STANDARD FEATURES**





- Clean lines and a contoured picture frame style back coordinate with any decor.
- Arms incorporate a firm grip extension to assist users in the entry and exit from the chair.
- Additional support rails on the legs ensure strength and durability.
- For added comfort, seats are standard with high density Ultracell bio foam
- Opaque non-marking glides are standard
- For Globalcare textiles and wood finish options, visit the website at [globalfurnituregroup.com](http://globalfurnituregroup.com)
- Models ending in FC have front casters
- Shipped fully assembled

**OPTIONAL FEATURES**

- For non-slip glides specify **(NS)**. Add \$32
- To add sealed seams to your product's back only contact Customer Care. Upcharges vary
- For moisture barrier **(MB)** (seat only) - Add \$119.

**SUGGESTED APPLICATIONS**

- Dining/Cafeteria
- Guest seating
- Lobbies
- Lounge/Waiting
- Office/Meeting
- Patient rooms
- Resident rooms

DESCRIPTION	MODEL#	STANDARD FABRIC GRADES											
		COM	2	3	4	5	6	7	8	9	10	11	12
 <p><b>Armchair</b> COM Yardage: 1.25 Freight Class: 300 Product Weight (lbs.): 24 Cubic Feet Per Carton: 14.5</p>	GC4162	\$1293	\$1322	\$1356	\$1402	\$1466	\$1495	\$1555	\$1648	\$1720	\$1799	\$1965	\$2140
		<b>OVERALL DIMENSIONS</b>			<b>SEAT DIMENSIONS</b>			<b>BACK DIMENSIONS</b>					
		W	D	H	W	D	H	W	H				
			24	22.5	36	22.5	18	17.5	17.5	18.5			
Active weight 300 lbs.													
 <p><b>Armchair w/Front Casters</b> COM Yardage: 1.25 Freight Class: 300 Product Weight (lbs.): 24 Cubic Feet Per Carton: 14.5</p>	GC4162FC	\$1380	\$1409	\$1443	\$1489	\$1553	\$1582	\$1642	\$1735	\$1805	\$1885	\$2051	\$2226
		<b>OVERALL DIMENSIONS</b>			<b>SEAT DIMENSIONS</b>			<b>BACK DIMENSIONS</b>					
		W	D	H	W	D	H	W	H				
			24	22.5	36	22.5	18	17.5	17.5	18.5			
Active weight 300 lbs.													
 <p><b>Side Chair</b> COM Yardage: 1.25 Freight Class: 300 Product Weight (lbs.): 22 Cubic Feet Per Carton: 14.5</p>	GC4165	\$1184	\$1218	\$1249	\$1294	\$1356	\$1387	\$1443	\$1535	\$1605	\$1683	\$1843	\$2016
		<b>OVERALL DIMENSIONS</b>			<b>SEAT DIMENSIONS</b>			<b>BACK DIMENSIONS</b>					
		W	D	H	W	D	H	W	H				
			22.5	22.5	36	22.5	18	17.5	17.5	18.5			
Active weight 300 lbs.													
 <p><b>Side Chair w/Front Casters</b> COM Yardage: 1.25 Freight Class: 300 Product Weight (lbs.): 22 Cubic Feet Per Carton: 14.5</p>	GC4165FC	\$1271	\$1305	\$1336	\$1381	\$1443	\$1474	\$1530	\$1622	\$1692	\$1770	\$1930	\$2102
		<b>OVERALL DIMENSIONS</b>			<b>SEAT DIMENSIONS</b>			<b>BACK DIMENSIONS</b>					
		W	D	H	W	D	H	W	H				
			22.5	22.5	36	22.5	18	17.5	17.5	18.5			
Active weight 300 lbs.													

## DESMOND HT



model GC4290

### EXAMPLE DESMOND HT ORDER CODE:

GC4290	-LX21	-BLK	-PT	-BK	-MB
Model #	Textile	Frame	Armcaps	Glides	Moisture Barrier

### STANDARD FEATURES

- Desmond HT is a metal framed chair with residential design while ensuring maximum strength and durability within very challenging applications.
- Available with four-legged metal welded frame with or without arms; with rear casters that allow the caregiver to tip and move chair without lifting. A bariatric model is available.
- Models with rear casters also allow the caregiver to turn the chair with occupant seated for better access to wheelchair or walker.
- The welded metal frame, welded cross rails on lower frame, metal-to-metal fasteners on seat pan, back insert and self-skinned urethane (SSU) armcaps enhance strength and durability, ensuring its performance in the most rigorous environments.
- Self-skinned urethane (SSU) armcaps are comfortable, durable, cleanable and replaceable. Designed to offer proper support while seated and the forward extension allows the occupant to use with confidence when getting in or out of the chair
- For added comfort and long term performance the seat cushion is standard with high density Ultracell bio foam
- The underside of the seat pan is moisture resistant, and the cushions have no exposed seams to support improved housekeeping and infection prevention practices
- For Globalcare textiles and finish options, visit the website at [globalfurnituregroup.com](http://globalfurnituregroup.com).
- Can be upholstered in standard Global textiles if Healthcare compliance is not required.
- Shipped fully assembled.

### OPTIONAL FEATURES

- To add additional weight to your product, contact Customer Care for more information.
- Moisture Barrier (**MB**) (Seat Only) - Add \$119 list upcharge.

Please add option codes in the following order:

- **Model number**  
**GC4290** Metal armchair  
**GC4291** Metal armchair w/two rear swivel casters  
**GC4293** Metal bariatric armchair  
**GC4294** Metal side chair, armless  
 - Add (**33**) to model # if CAL TB 133 is required.
- **Textile**  
 Specify fabric code.
- **Frame finish**  
**(BLK)** Black  
**(LAB)** Latte  
**(KAL)** Kalua  
**(J52)** Mocha  
**(SHW)** Shadow  
**(TOA)** Toast  
**(TUN)** Tungsten
- **Armcap finish**  
**(SS)** Black  
**(LT)** Latte  
**(KL)** Kalua  
**(MC)** Mocha  
**(SW)** Shadow  
**(TO)** Toast
- **Glides**  
**(BK)** Black plastic glides
- **Moisture Barrier**  
**(MB)** Seat only

### SUGGESTED APPLICATIONS

- Dining/Cafeteria
- Guest seating
- Lobbies
- Lounge/Waiting
- Office/Meeting
- Patient rooms
- Resident rooms
- Bariatric seating (model GC4293)

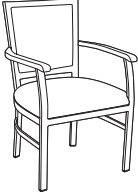
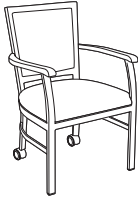
DESCRIPTION	MODEL#	STANDARD FABRIC GRADES											
		COM	2	3	4	5	6	7	8	9	10	11	12
 <b>Metal Armchair</b> COM Yardage: 1.25 Freight Class: 250 Product Weight (lbs.): 41 Cubic Feet Per Carton: 13.75	GC4290	\$1284	\$1318	\$1350	\$1395	\$1456	\$1487	\$1543	\$1635	\$1705	\$1784	\$1943	\$2115
		<b>OVERALL DIMENSIONS</b>			<b>SEAT DIMENSIONS</b>			<b>BACK DIMENSIONS</b>					
		W	D	H	W	D	H	W	H				
		24.5	23.5	35.75	23	19	18.5	18	17.5				
 <b>Metal Armchair w/Two Rear Swivel Casters</b> COM Yardage: 1.25 Freight Class: 250 Product Weight (lbs.): 41 Cubic Feet Per Carton: 13.75	GC4291	\$1416	\$1450	\$1482	\$1527	\$1588	\$1619	\$1675	\$1767	\$1837	\$1916	\$2075	\$2247
		<b>OVERALL DIMENSIONS</b>			<b>SEAT DIMENSIONS</b>			<b>BACK DIMENSIONS</b>					
		W	D	H	W	D	H	W	H				
		24.5	23.5	35.75	23	19	18.5	18	17.5				

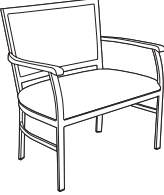

DESCRIPTION	MODEL#	STANDARD FABRIC GRADES											
		COM	2	3	4	5	6	7	8	9	10	11	12
 <p><b>Metal Bariatric Armchair</b>                      COM Yardage: 2.25                      Freight Class: 250                      Product Weight (lbs.): 48                      Cubic Feet Per Carton: 20</p>	GC4293	\$1707	\$1771	\$1829	\$1908	\$2020	\$2073	\$2179	\$2341	\$2468	\$2608	\$2897	\$3206
		OVERALL DIMENSIONS			SEAT DIMENSIONS			BACK DIMENSIONS					
		W	D	H	W	D	H	W	H				
			35.5	23.5	35.75	34	19	18.5	29	17.5			

DESCRIPTION	MODEL#	STANDARD FABRIC GRADES											
		COM	2	3	4	5	6	7	8	9	10	11	12
 <p><b>Metal Side Chair, Armless</b>                      COM Yardage: 1.25                      Freight Class: 250                      Product Weight (lbs.): 36                      Cubic Feet Per Carton: 13.75</p>	GC4294	\$1158	\$1192	\$1224	\$1269	\$1330	\$1361	\$1417	\$1509	\$1579	\$1658	\$1817	\$1989
		OVERALL DIMENSIONS			SEAT DIMENSIONS			BACK DIMENSIONS					
		W	D	H	W	D	H	W	H				
			23	23.5	35.75	23	19	18.5	18	17.5			

DOCTOR BUDDY



model GC1104



STANDARD FEATURES

- Doctor Buddy is the perfect stool to provide comfort when performing office tasks or as an examination or feeding stool when caring for others.
- Swivel stool, seat upholstered in vinyl or fabric with Ultracell foam cushion.
- Moisture resistant protection on underside of seat pan.
- 16" seat diameter with Black five-legged injection-molded base.
- **C65 casters are standard.**

- For hard surface flooring casters, specify **C65R. Add \$66** list upcharge.
- For Globalcare textiles and finish options, visit the website at [www.globalfurnituregroup.com](http://www.globalfurnituregroup.com)
- This product can be upholstered in standard Global textiles only if healthcare compliance is not required.

SUGGESTED APPLICATIONS

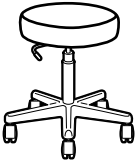
- Exam Rooms
- Patient Rooms

DESCRIPTION	MODEL#	STANDARD FABRIC GRADES											
		1	2	3	4	5	6	7	8	9	10	11	12
 <p><b>Swivel Stool 5" Pneumatic, 20" Base</b> COM Yardage: 0.75 Freight Class: 150 Product Weight (lbs.): 15 Cubic Feet Per Carton: 2.9</p>	GC1104	\$440	\$465	\$486	\$513	\$555	\$574	\$604	\$674	\$704	\$768	\$855	\$962
		OVERALL DIMENSIONS			SEAT DIMENSIONS			BACK DIMENSIONS					
		W	D	H	W	D	H	W	H				
Active weight 300 lbs. For hardsurface flooring casters - <b>Add \$66</b> list upcharge.		16	16	18.5	16	--	16.5 - 21.5	--	--				
 <p><b>Swivel Stool 10" Pneumatic, 22" Base</b> COM Yardage: 0.75 Freight Class: 125 Product Weight (lbs.): 18 Cubic Feet Per Carton: 2.9</p>	GC1109	\$468	\$494	\$513	\$542	\$584	\$603	\$633	\$703	\$732	\$798	\$885	\$990
		OVERALL DIMENSIONS			SEAT DIMENSIONS			BACK DIMENSIONS					
		W	D	H	W	D	H	W	H				
Active weight 300 lbs. For hardsurface flooring casters - <b>Add \$66</b> list upcharge.		16	16	27.5	16	--	22.5 - 32.5	--	--				

DREME



Sleeper with back and arms  
model GC35042

EXAMPLE DREME ORDER CODE:

GC35042	-LE50	-	-BM21	-LPN	-AWH
---------	-------	---	-------	------	------

Model #	Textile	Arm/tablet location	Sleep surface textile	Front panel type (LPN, UPN, LPP, UPP)	Laminate panel finish
---------	---------	---------------------	-----------------------	---------------------------------------	-----------------------

-SRL	-TOA	-MB
Storage	Leg finish/caster option	Moisture barrier



Drawer box surface

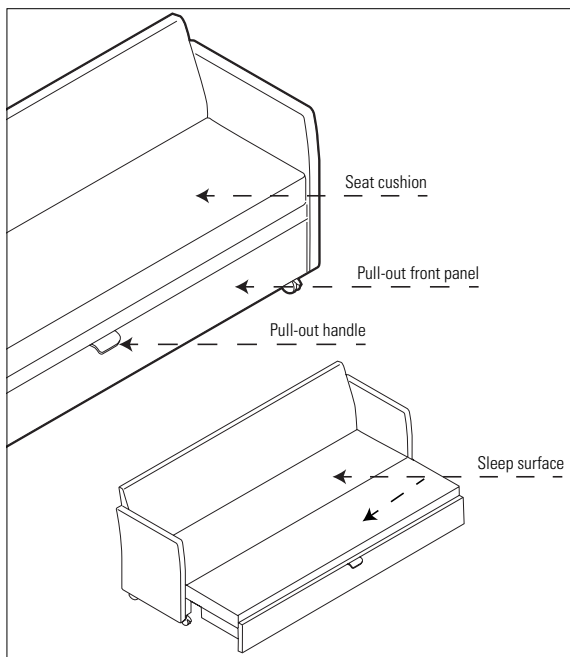

STANDARD FEATURES

- Dreme has a compact, comfortable design that offers a place to sit and converts into a generous sleep surface with a simple pull and flip. A variety of models include backless/armless benches and 3-seater sofa models with or without arms and tablets.
- The seat deck is a clean through metal platform for superior strength.
- The seat/sleep cushion is attached to the unit with straps held in place by metal-to-metal fasteners allowing sheets to be tucked in place.
- Straps can be unfastened for field replacement of the cushion, if required for any reason.
- A clean through is located at the back of the seat cushion, extending to the floor supporting ease of cleaning.
- The seat cushion folds open to create a 36" deep sleep surface area. Foam is standard high density Ultracell, for enhanced comfort and long-term performance.
- A pull-out section below the seat deck slides forward to support the sleep surface.
- The sleep surface cushion and drawer box covering are upholstered in Bantam vinyl to ensure moisture barrier protection. These surfaces are 9:1 (water to bleach) cleanable. Please select **(BM)** color. See Morbern Bantam textile card for color samples. All other surfaces can be specified in your textile of choice.
- A curved, chrome pull handle is standard on the pull-out front panel of all Dreme models.
- The pull-out is supported by four heavy duty non-locking, swivel casters when in sleep position and is standard without storage.
- Dreme requires zero wall clearance to open into sleep position.
- Standard configuration for all models: two metal legs in front position, two non-locking swivel casters in back position (to assist with moving the unit). Optional front, locking, swivel casters **(FC)** are available. Add **\$74**.
- Legs are available in all Globalcare metal paint finishes.
- Models with a tablet are available with left, right or both sofa arms. On models with both arms, specify left **(LT)**, right **(RT)** or **(TB)** for tablets on both arms (add **\$300** for **TB**). Tablet and arms are designated based on seated position. The tablet surfaces attach to the outside of the arm. The tablet rotates up and can be swiveled over the arm into place for use by the occupant. The strong, oval tablet is a soft black colored, non-porous, phenolic material with a no-spill edge.
- Interior sleep surface: 79" L x 37" W
- All textiles are railroaded across all Dreme components.
- For healthcare textiles, visit the website at [globalfurnituregroup.com/healthcare](http://globalfurnituregroup.com/healthcare).
- Can be upholstered in standard Global textiles if healthcare compliance is not required.

OPTIONAL FEATURES

- The pull-out is available with a storage compartment option. The storage compartment is divided into two sides, both with clean through spaces, and is finished in Hayden Grey (HGT) laminate. The storage compartment must be ordered at time of original order and cannot be retrofitted, specify **(SRB)**. Add **\$413**.
- Storage compartment lids have a pneumatic lift support, allowing the lid to stay open when accessing the interior storage area.
- An optional seamless drawer liner is available for the storage compartments, as a set of two. Liners can be removed for ease of maintenance, specify **(SRL)**. Add **\$824**.
- Pull-out front panel is available with or without power units, and either upholstered or laminate. Specify one of the following:  
**(LPN)** laminate panel  
**(UPN)** upholstered panel  
**(LPP)** laminate panel with power. Add **\$220**.  
**(UPP)** upholstered panel with power. Add **\$220**.  
Select from all standard laminate finishes.
- The optional power unit is located on the front panel, center front position. The tamper-resistant unit includes one power and two, USB-A, 10 watt charging ports with an 8 ft. long power cord. When the pull-out is in the open position, the remaining power cord length is 6 ft. The power module is Black with Black face plate and must be specified at time of order.
- **Leg finish/caster option:**  
**(BLK)** Black  
**(KAL)** Kalua  
**(LAB)** Latte  
**(J52)** Mocha  
**(SHW)** Shadow  
**(TOA)** Toast  
**(TUN)** Tungsten  
**(FC)** Front, locking, swivel casters. Add **\$74**. (Casters are Black with Taupe center)
- **Sleep Surface Finish:**  
**(BM21)** Apple  
**(BM25)** Cosmic  
**(BM23)** Dove  
**(BM26)** Firelight  
**(BM22)** Ghost  
**(BM27)** Ginger  
**(BM24)** Iron  
**(BM20)** Rabbit  
**(BM28)** Tropical  
See finishes at [globalfurnituregroup.com/workplace/resources/textiles](http://globalfurnituregroup.com/workplace/resources/textiles) - Global Carded Textiles
- For moisture barrier on full seat and sleeping surface, specify **(MB)**. Add **\$479**.
- To add sealed seams to your product, specify **(SS)**. Add **\$449**.

SUGGESTED APPLICATIONS

- Lounge
- Patient rooms
- Resident rooms
- Treatment/Exam rooms

# SEATING

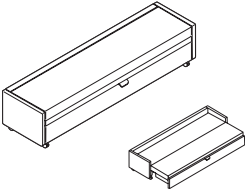
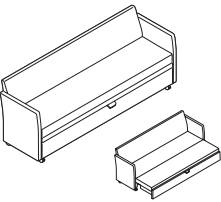
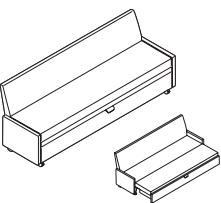
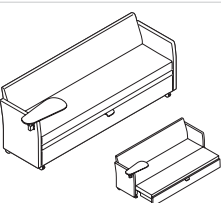
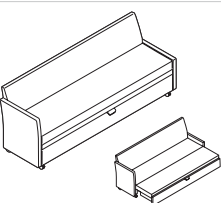
DESCRIPTION	MODEL#	STANDARD FABRIC GRADES												
		COM	2	3	4	5	6	7	8	9	10	11	12	
 <p><b>Armless Sleeper</b> COM Yardage: 9.5 Freight Class: 125 Product Weight (lbs.): 158 Cubic Feet Per Carton: 22.75</p>	GC35041NA	\$4792	\$5099	\$5346	\$5719	\$6243	\$6489	\$6965	\$7723	\$8307	\$8957	\$10293	\$11720	
			OVERALL DIMENSIONS			SEAT DIMENSIONS			BACK DIMENSIONS					
			W	D	H	W	D	H	W	H				
	Active weight 450 lbs.		82	23	18.5	78	--	18.5						
 <p><b>Sleeper w/Back and Arms</b> COM Yardage: 11.75 Freight Class: 150 Product Weight (lbs.): 210 Cubic Feet Per Carton: 46.25</p>	GC35042	\$5434	\$5802	\$6100	\$6544	\$7174	\$7470	\$8041	\$8953	\$9656	\$10435	\$12040	\$13754	
			OVERALL DIMENSIONS			SEAT DIMENSIONS			BACK DIMENSIONS					
			W	D	H	W	D	H	W	H				
	Active weight 450 lbs.		82	25	32.5	78	18	18.5	78	14				
 <p><b>Armless Sleeper w/Back</b> COM Yardage: 11.45 Freight Class: 150 Product Weight (lbs.): 190 Cubic Feet Per Carton: 46.25</p>	GC35042NA	\$5285	\$5637	\$5923	\$6350	\$6953	\$7236	\$7784	\$8655	\$9328	\$10076	\$11615	\$13256	
			OVERALL DIMENSIONS			SEAT DIMENSIONS			BACK DIMENSIONS					
			W	D	H	W	D	H	W	H				
	Active weight 450 lbs.		82	25	32.5	78	18	18.5	78	14				
 <p><b>Sleeper w/Back, Arms and Tablet</b> COM Yardage: 11.75 Freight Class: 150 Product Weight (lbs.): 210 Cubic Feet Per Carton: 48.5</p>	GC35042T	\$5752	\$6114	\$6407	\$6844	\$7464	\$7754	\$8316	\$9213	\$9903	\$10668	\$12248	\$13932	
			OVERALL DIMENSIONS			SEAT DIMENSIONS			BACK DIMENSIONS					
			W	D	H	W	D	H	W	H				
	Active weight 450 lbs.		86	25	32.5	78	18	18.5	78	14				
Specify (LT) for left tablet or (RT) for right tablet. Specify (TB) for tablet on both arms. Add \$300.														
 <p><b>Sleeper w/Back and one Arm</b> COM Yardage: 11.95 Freight Class: 150 Product Weight (lbs.): 200 Cubic Feet Per Carton: 46.25</p>	GC35043	\$5434	\$5802	\$6100	\$6544	\$7174	\$7470	\$8041	\$8953	\$9656	\$10435	\$12040	\$13754	
			OVERALL DIMENSIONS			SEAT DIMENSIONS			BACK DIMENSIONS					
			W	D	H	W	D	H	W	H				
	Active weight 450 lbs.		82	25	32.5	78	18	18.5	78	14				
Specify (AR) for right arm or (AL) for left arm.														

DESCRIPTION	MODEL#	STANDARD FABRIC GRADES											
		COM	2	3	4	5	6	7	8	9	10	11	12

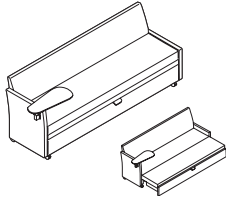

<b>GC35043T</b>	<b>\$5768</b>	<b>\$6114</b>	<b>\$6395</b>	<b>\$6813</b>	<b>\$7407</b>	<b>\$7685</b>	<b>\$8223</b>	<b>\$9079</b>	<b>\$9742</b>	<b>\$10475</b>	<b>\$11988</b>	<b>\$13600</b>
-----------------	---------------	---------------	---------------	---------------	---------------	---------------	---------------	---------------	---------------	----------------	----------------	----------------

Specify (RT) for right arm or (LT) for left arm.

OVERALL DIMENSIONS			SEAT DIMENSIONS			BACK DIMENSIONS	
W	D	H	W	D	H	W	H
86	25	32.5	78	18	18.5	78	14

**Sleeper w/Back, Single Arm and Tablet**  
 COM Yardage: 11.25  
 Freight Class: 150  
 Product Weight (lbs.): 205  
 Cubic Feet Per Carton: 47.5

Active weight 450 lbs.

## ERIN



**model GC36530**  
Armless Guest Chair, Wood Legs



**model GC36533**  
Guest Armchair, Metal Legs

### STANDARD FEATURES

- Erin offers a streamlined silhouette brimming with mid-century modern style.
- A rounded arch gently curves around and under the seat to give extra support to a user's upper back and sides, while creating an open clean-out space at the back of the cushion.
- Tapered legs add style and elegance.
- Legs are available in wood or metal painted/plated finishes (noted).
- The seat underside is sealed with a non-porous material to support housekeeping and infection control protocols.
- Additional improved cleaning options include sealed seams (back and/or seat) and moisture barrier (seat). Upcharges apply.
- Assembled with tamper-resistant fasteners for greater security.
- For added comfort, the seat cushions are standard with high density Ultracell foam.
- Glides are self-leveling. Choose from standard non-marking glides, rubber non-slip glides or felt glides (upcharges apply).
- The Globalcare warranty (for healthcare and 24/7 environments) applies for all Erin GC models when performance textiles are selected. Visit the website at [globalfurnituregroup.com/healthcare](http://globalfurnituregroup.com/healthcare).
- Global's standard lifetime warranty applies when approved standard Global textiles are selected.
- Shipped fully assembled.

### SUGGESTED APPLICATIONS

- Dining/Cafeteria
- Guest seating
- Lobbies
- Lounge/Waiting
- Patient rooms
- Resident rooms





### OPTIONAL FEATURES

Please add option codes in the following order:

- **Model number**  
**GC36530** Guest armless chair, wood legs  
**GC36531** Guest armless chair, metal legs  
**GC36532** Guest armchair, wood legs  
**GC36533** Guest armchair, metal legs
- **Seat and Back Textile**  
Specify textile code.
- **Wood leg finish** (models GC36530 and GC36532)  
**(AAM)** Absolute **(MWM)** Medium Walnut  
**(BKM)** Black **(NLW)** Natural Walnut  
**(CJM)** Charcoal Java **(ASM)** Night  
**(ACM)** Cherry **(NBM)** Noce Biondo  
**(EMM)** Empire Mahogany **(NGM)** Noce Grigio  
**(EOM)** English Oak **(NEM)** Noce Leggero  
**(ECM)** Espresso Cafe **(NMM)** Noce Medio  
**(TFM)** Fruitwood **(SBM)** Sandy Beach  
**(HGM)** Grey **(SKM)** Shaker Cherry  
**(HOM)** Harvest Oak **(SOM)** Silver Oak  
**(AHM)** Honey **(TWM)** Walnut  
**(JOM)** Jet Onyx **(WTM)** WC Cream  
**(LHM)** Light Honey **(WHM)** White  
**(TMM)** Mahogany **(WCM)** Winter Cherry  
**(AVM)** Maple
- **Metal leg finish** (models GC36531 and GC36533)  
**(CHM)** Chrome **(TTU)** Tungsten  
**(TBL)** Black **(TKA)** Kalua  
**(TLA)** Latte **(TMO)** Mocha  
**(TSH)** Shadow **(TOA)** Toast
- **Glides**  
**(NM)** Non-marking glide. No upcharge  
**(RG)** Rubber, non-slip glide. Add \$55.  
**(FG)** Felt glide. Add \$55.
- **Sealed Back Seams**  
**(NBS)** No sealed back seams  
**(SBS)** Sealed back seams. Upcharges vary, see model.
- **Sealed Seat Seams**  
**(NSS)** No sealed seat seams  
**(SSS)** Sealed seat seams. Add \$18.
- **Moisture Barrier**  
**(NB)** No moisture barrier. No upcharge.  
**(MB)** Moisture barrier (seat only). Add \$101.

### EXAMPLE ERIN ORDER CODE:

GC36530	CE90	AAM	NM	NBS	NSS	NB
Model #	Seat and back textile	Leg finish	Glide	Sealed Back Seams	Sealed Seat Seams	Moisture Barrier

DESCRIPTION	MODEL#	STANDARD FABRIC GRADES											
		1/COM	2	3	4	5	6	7	8	9	10	11	12
 <p><b>Armless Guest Chair, Wood Legs</b>                      COM Yardage: 2.75                      Freight Class: 250                      Product Weight (lbs.): 32.5                      Cubic Feet Per Carton: 13.25</p>	GC36530	\$1751	\$1839	\$1908	\$2010	\$2153	\$2213	\$2337	\$2532	\$2678	\$2838	\$3170	\$3520
		OVERALL DIMENSIONS			SEAT DIMENSIONS			BACK DIMENSIONS					
		W	D	H	W	D	H	W	H				
	24	22.25	34	19	18	19	15	15.5					
		Active weight 350 lbs. Add \$45 for (SBS), \$18 for (SSS)											
 <p><b>Armless Guest Chair, Metal Legs</b>                      COM Yardage: 2.75                      Freight Class: 250                      Product Weight (lbs.): 34.5                      Cubic Feet Per Carton: 13.25</p>	GC36531	COM	2	3	4	5	6	7	8	9	10	11	12
		\$1667	\$1755	\$1824	\$1926	\$2069	\$2129	\$2253	\$2448	\$2594	\$2754	\$3086	\$3436
		OVERALL DIMENSIONS			SEAT DIMENSIONS			BACK DIMENSIONS					
W	D	H	W	D	H	W	H						
	24	22.25	34	19	18	19	15	15.5					
		Active weight 350 lbs. Add \$45 for (SBS), \$18 for (SSS)											
 <p><b>Guest Armchair, Wood Legs</b>                      COM Yardage: 2.75                      Freight Class: 250                      Product Weight (lbs.): 33                      Cubic Feet Per Carton: 13.25</p>	GC36532	COM	2	3	4	5	6	7	8	9	10	11	12
		\$1751	\$1839	\$1908	\$2010	\$2153	\$2213	\$2337	\$2532	\$2678	\$2838	\$3170	\$3520
		OVERALL DIMENSIONS			SEAT DIMENSIONS			BACK DIMENSIONS					
W	D	H	W	D	H	W	H						
	24	22	34.25	19	18.5	18.5	17	15.75					
		Active weight 350 lbs. Add \$48 for (SBS), \$18 for (SSS)											
 <p><b>Guest Armchair, Metal Legs</b>                      COM Yardage: 2.75                      Freight Class: 250                      Product Weight (lbs.): 35                      Cubic Feet Per Carton: 13.25</p>	GC36533	COM	2	3	4	5	6	7	8	9	10	11	12
		\$1667	\$1755	\$1824	\$1926	\$2069	\$2129	\$2253	\$2448	\$2594	\$2754	\$3086	\$3436
		OVERALL DIMENSIONS			SEAT DIMENSIONS			BACK DIMENSIONS					
W	D	H	W	D	H	W	H						
	24	22	34.25	19	18.5	18.5	17	15.75					
		Active weight 350 lbs. Add \$48 for (SBS), \$18 for (SSS)											

## FLAP™



**Folding Chair**  
model 6775

### STANDARD FEATURES





- A modern design, high quality, lightweight, all polymer folding chair intended for use indoors or outdoors. Products must be stored inside during extreme and inclement weather. See Global's Outdoor Furniture warranty for additional information.
- Weather resistant, UV resistant, stain resistant, 100% non-ferrous, and recyclable design that is 1:10 bleach solution cleanable.
- Chair legs are equipped with clear non-marking glides as standard. Suitable for outdoor environments, carpet and hard surface flooring
- Chairs are stocked in 2 colors:  
Alloy (**ALY**)  
Milk (**MLK**)
- No upholstery options available
- Rated to 275 lbs.
- Single chair folds flat to 2.2" (55 mm).
- Flap achieves its strength and durability using glass filled polymer. Evidence of this material may be visible on the surface and is often more evident in darker colors.
- The Flap Wall Hook (6776), sold individually, supports up to two folded Flap chairs. This Milk (**MLK**) colored plastic hook mounts on walls or inside closets and wardrobe cabinets providing easy access to extra seating. Two chairs on Wall Hook measure 7.3" (185 mm) deep off wall. Mounting hardware not included. Recommended mounting into stud.
- Flap Ganging Brackets (6778) are sold 12 to a box. These translucent, frosted plastic brackets attach across two adjacent chairs, just above or below the seat to provide temporary ganging for organized events.
- The Flap Dolly (6777), ordered separately, supports up to 24 chairs folded and stacked flat. Includes strap to secure chairs for storage and transport.

Please add option codes in the following order

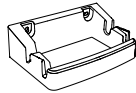

- **Model number**  
6775 Folding Chair  
6776 Wall Hook  
6777 Dolly  
6778 Ganging Brackets
- **Chair Color**  
(ALY) Alloy  
(MLK) Milk

### EXAMPLE OF FLAP ORDER CODE:

6775	ALY
Model Number	Finish

DESCRIPTION	FEATURES	MODEL#												STANDARD TEXTILE GRADES													
		1	2	3	4	5	6	7	8	9	10	11	12	1	2	3	4	5	6	7	8	9	10	11	12		
 <b>Folding Chair</b> COM Yardage: N/A Freight Class: 100 Product Weight (lbs.): 13.5 Cubic Feet Per Carton: 1.6	Shipped 2 per box. Ordered as eaches.	<b>6775</b>												<b>\$214</b>													
		<b>OVERALL DIMENSIONS</b>				<b>SEAT DIMENSIONS</b>				<b>BACK DIMENSIONS</b>																	
		<b>W</b>	<b>D</b>	<b>H</b>		<b>W</b>	<b>D</b>	<b>H</b>		<b>W</b>	<b>D</b>	<b>H</b>		<b>W</b>	<b>D</b>	<b>H</b>		<b>W</b>	<b>D</b>	<b>H</b>		<b>W</b>	<b>D</b>	<b>H</b>			
		19	21.5	33.5		16	16.5	18.5		18.5	16																
														2 per carton (pricing and specifications are for one chair)													
 <b>Flap Wall Hook</b> COM Yardage: N/A Freight Class: 70 Product Weight (lbs.): 0.75 Cubic Feet Per Carton: 0.2		<b>6776</b>												<b>\$48</b>													
		<b>OVERALL DIMENSIONS</b>				<b>SEAT DIMENSIONS</b>				<b>BACK DIMENSIONS</b>																	
		<b>W</b>	<b>D</b>	<b>H</b>		<b>W</b>	<b>D</b>	<b>H</b>		<b>W</b>	<b>D</b>	<b>H</b>		<b>W</b>	<b>D</b>	<b>H</b>		<b>W</b>	<b>D</b>	<b>H</b>		<b>W</b>	<b>D</b>	<b>H</b>			
		9	6	2.75																							
														1 per carton													

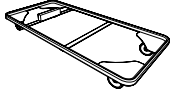

DESCRIPTION	MODEL#	STANDARD FABRIC GRADES											
		1	2	3	4	5	6	7	8	9	10	11	12
 <p><b>Dolly for Flap Folding Chairs</b>                      COM Yardage: N/A                      Freight Class: 150                      Product Weight (lbs.): 23                      Cubic Feet Per Carton: 4.5</p>	6777	\$614											
		OVERALL DIMENSIONS			SEAT DIMENSIONS			BACK DIMENSIONS					
		W	D	H	W	D	H	W	H				
		20.75	44	5.25									
		Holds up to 24 Flap folded chairs. Includes tether strap.		RTA 00	ups	1 per carton							
 <p><b>Flap Ganging Bracket (box of 12)</b>                      COM Yardage: N/A                      Freight Class: 70                      Product Weight (lbs.): 0.29                      Cubic Feet Per Carton: 0.03</p>	6778	\$188											
		OVERALL DIMENSIONS			SEAT DIMENSIONS			BACK DIMENSIONS					
		W	D	H	W	D	H	W	H				
		0	0	0									
				RTA 00	ups	12 per carton (pricing and specifications are for box of 12)							

## FOOT ACTIVATED STOOLS



model GC9604FG

model GC9668FG

### STANDARD FEATURES

- Foot activated stools allow the occupant to adjust the gas cylinder by pressing on the ring below the base with their foot, which frees up hands to manage other tasks while working in a lab.
- Raise the seat by pressing on the ring before sitting; or lower the seat by pressing on the ring while seated.
- Swivel stool with 8" gas cylinder provides seat height range of 21.5" to 29.5".
- Seamless upholstered seat cushion is constructed from high density Ultracell foam.
- Underside of seat cushion is finished with polyurethane.
- 14" seat diameter with 25" diameter Black five prong injection molded base.
- Standard with dual wheel hard floor casters (C10R).
- For Globalcare textiles and finish options, visit the website at [globalfurnituregroup.com](http://globalfurnituregroup.com).
- Can be upholstered in standard Global textiles only if Healthcare compliance is not required.

### OPTIONAL FEATURES

- To respond to higher expectations for housekeeping and infection prevention, seat underside can be completely sealed. Contact Customer Care for upcharge.

### SUGGESTED APPLICATIONS

- Dining/Cafeteria
- Office/Meeting
- Patient rooms
- Resident rooms
- Treatment/Exam rooms

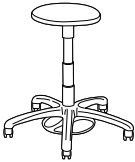
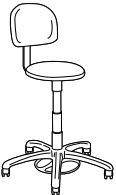
DESCRIPTION	MODEL# / FEATURES	STANDARD TEXTILE GRADES											
		COM	2	3	4	5	6	7	8	9	10	11	12
 <p><b>Lab Swivel Stool</b> COM Yardage: 0.75 Freight Class: 250 Product weight (lbs.): 25 Cubic Feet per Carton: 9.75</p>	GC9604FG	\$723	\$744	\$765	\$792	\$832	\$852	\$887	\$944	\$988	\$1037	\$1138	\$1245
		OVERALL DIMENSIONS			SEAT DIMENSIONS			BACK DIMENSIONS					
		W	D	H	W	D	H	W	H				
		14	14	25.5	14	--	21.5-29.5						
 <p><b>Lab Swivel Stool w/Small Upholstered Back</b> COM Yardage: 1 Freight Class: 250 Product weight (lbs.): 32 Cubic Feet per Carton: 13</p>	GC9668FG	\$854	\$883	\$909	\$947	\$1000	\$1024	\$1072	\$1148	\$1208	\$1274	\$1406	\$1550
		OVERALL DIMENSIONS			SEAT DIMENSIONS			BACK DIMENSIONS					
		W	D	H	W	D	H	W	H				
		14	14	38	14	--	21.5-29.5	14	12.5				

FROLICK & SPLASH



model GC3001

model GC3011

Three different back constructions



Separate panel piece closes the lower back to conceal the support bracket. Offered in **Frolick** series on select models.



Single piece back with a pullover style upholstery cover and support bracket fastened on the outer back. Offered on select **Frolick** models.



Two piece back covering the back support brackets when fastened in place. Offered in **Splash** series.

STANDARD FEATURES

- Frolick and Splash are multi-purpose stacking chairs that share generous width between the arms, great comfort, and a frame built for greater strength and stability. Each series offers a different back design with special features to best address the application and infection control practices.
- Standard size models offer 19" seat width with 21.5" clearance between the armrests. Bariatric size models offer 31.5" seat width with 33.5" clearance between the armrests.
- For a smaller scale bariatric chair, refer to GC Comet #GC2180 which offers 18.5" seat width with 28" clearance between armrests
- Heavy duty round, tubular gusseted frames available in Black (BLK), Latte (LAB), Kalua (KAL), Mocha (J52), Shadow (SHW), Toast (TOA) and Tungsten (TUN). Please specify.
- Active weight capacity is up to 300 lbs. for standard models, and 500 lbs. for Bariatric models.
- Protective Platinum color seat shroud is standard on all models (except bariatric models GC3003 and GC3023).
- To respond to higher expectations for housekeeping and infection control practices, select models with a one-piece back. Description of back is noted with each model
- Wallsaver rear legs eliminate accidental damage to walls.
- Armrests are fiberglass reinforced Nylon and have a flat profile. Fully extended to front of seat edge to assist in entry and exit from the chair.
- Armrests are standard in Black.
- For added comfort, seats are standard with high density Ultracell bio foam
- Four legged standard size models stack 5 high without dolly and 8 high on GC3010 dolly.
- **Four legged Bariatric models stack 2 high only** - No dolly available.
- Sled base models do not stack
- For ganging brackets, see Model 2180 in the Global Seating List Price Book.
- Black frames are standard with Black glides and front leg caps on armless models. All other frame colors are standard with Platinum glides and front leg caps on armless models
- For Globalcare textiles and finish options, visit the website at [globalfurnituregroup.com](http://globalfurnituregroup.com)
- Can be upholstered in standard Global textiles only if Healthcare compliance is not required.

OPTIONAL FEATURES

- A selection of glide options is available. Glides must be chosen to best suit flooring type and site conditions.
- For hard surface floors, please specify opaque non-marking glides (**WH**). No upcharge.
- Glides with felt pads (**FG**) are available for vinyl sheet, cork or laminate flooring. Please specify. Add **\$55**.
- Glides with rubber pads (**RG**) are available for vinyl, hardwood, laminate, stone or ceramic flooring. Please specify. Add **\$55**.
- Armrests available in Shadow (**SHW**) and Toast (**TOA**). Please Specify. Add **\$40**.
- To add sealed seams to your product contact Customer Care. Upcharges vary
- For moisture barrier on seat, add \$119 per seat. For Bariatric models - Add \$183 per seat.

SUGGESTED APPLICATIONS

- Bariatric seating (Frolick)
- Dining/Cafeteria
- Guest seating
- Lobbies
- Lounge/Waiting
- Office/Meeting
- Patient rooms
- Resident rooms
- Stacking
- Treatment/Exam Rooms

DESCRIPTION	MODEL#	STANDARD FABRIC GRADES											
		COM	2	3	4	5	6	7	8	9	10	11	12
 <p><b>Frolick Stacking Armchair</b> 4 Leg Base, Rectangular back with concealed attachment COM Yardage: 1.25 Freight Class: 250 Product Weight (lbs.): 24 Cubic Feet Per Carton: 6.67</p>	GC3001	\$756	\$790	\$824	\$871	\$935	\$960	\$1016	\$1125	\$1177	\$1278	\$1416	\$1588
		OVERALL DIMENSIONS			SEAT DIMENSIONS			BACK DIMENSIONS					
		W	D	H	W	D	H	W	H				
		25	24.5	36	19	18	18.5	19.5	17				

DESCRIPTION	MODEL#	STANDARD FABRIC GRADES											
		COM	2	3	4	5	6	7	8	9	10	11	12
 <p><b>Frolick Stacking Chair</b> Armless, 4 Leg Base, Rectangular back with concealed attachment                      COM Yardage: 1.25                      Freight Class: 250                      Product Weight (lbs.): 22                      Cubic Feet Per Carton: 6.67</p>	<b>GC3002</b>	\$721	\$758	\$791	\$838	\$903	\$927	\$984	\$1093	\$1145	\$1245	\$1384	\$1557
	<b>OVERALL DIMENSIONS</b>			<b>SEAT DIMENSIONS</b>			<b>BACK DIMENSIONS</b>						
	<b>W</b>	<b>D</b>	<b>H</b>	<b>W</b>	<b>D</b>	<b>H</b>	<b>W</b>	<b>H</b>					
	21	24.5	36	19	18	18.5	19.5	17					

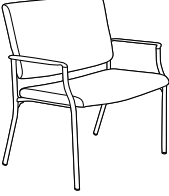
 <p><b>Frolick Bariatric Stacking Armchair</b> 4 Leg Base, Rectangular back with concealed attachment                      COM Yardage: 2.25                      Freight Class: 300                      Product Weight (lbs.): 42                      Cubic Feet Per Carton: 26.5</p>	<b>GC3003</b>	\$1380	\$1446	\$1505	\$1587	\$1704	\$1748	\$1851	\$2044	\$2143	\$2323	\$2572	\$2881
	<b>OVERALL DIMENSIONS</b>			<b>SEAT DIMENSIONS</b>			<b>BACK DIMENSIONS</b>						
	<b>W</b>	<b>D</b>	<b>H</b>	<b>W</b>	<b>D</b>	<b>H</b>	<b>W</b>	<b>H</b>					
	37	24.5	36.5	31.5	18	18.5	32	18.5					

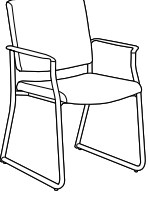
 <p><b>Frolick Armchair</b> Sled Base, Rectangular back with concealed attachment                      COM Yardage: 1.25                      Freight Class: 250                      Product Weight (lbs.): 32                      Cubic Feet Per Carton: 13.75</p>	<b>GC3021</b>	\$783	\$820	\$852	\$899	\$964	\$988	\$1045	\$1153	\$1205	\$1307	\$1445	\$1617
	<b>OVERALL DIMENSIONS</b>			<b>SEAT DIMENSIONS</b>			<b>BACK DIMENSIONS</b>						
	<b>W</b>	<b>D</b>	<b>H</b>	<b>W</b>	<b>D</b>	<b>H</b>	<b>W</b>	<b>H</b>					
	25	24.5	36	18	17	18.5	18.75	18					

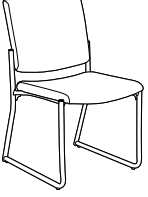
 <p><b>Frolick Armless Chair</b> Sled Base, Rectangular back with concealed attachment                      COM Yardage: 1.25                      Freight Class: 250                      Product Weight (lbs.): 30                      Cubic Feet Per Carton: 13.75</p>	<b>GC3022</b>	\$751	\$785	\$819	\$866	\$929	\$954	\$1011	\$1120	\$1172	\$1272	\$1410	\$1583
	<b>OVERALL DIMENSIONS</b>			<b>SEAT DIMENSIONS</b>			<b>BACK DIMENSIONS</b>						
	<b>W</b>	<b>D</b>	<b>H</b>	<b>W</b>	<b>D</b>	<b>H</b>	<b>W</b>	<b>H</b>					
	21	24.5	36	19	18	18.5	19.5	17					

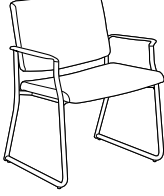
 <p><b>Frolick Bariatric Armchair</b> Sled Base, Rectangular back with concealed attachment                      COM Yardage: 2.25                      Freight Class: 300                      Product Weight (lbs.): 47                      Cubic Feet Per Carton: 26.5</p>	<b>GC3023</b>	\$1467	\$1533	\$1593	\$1674	\$1793	\$1836	\$1941	\$2131	\$2230	\$2411	\$2660	\$2970
	<b>OVERALL DIMENSIONS</b>			<b>SEAT DIMENSIONS</b>			<b>BACK DIMENSIONS</b>						
	<b>W</b>	<b>D</b>	<b>H</b>	<b>W</b>	<b>D</b>	<b>H</b>	<b>W</b>	<b>H</b>					
	37	24.5	36.5	31.5	18	18.5	32	18.5					

DESCRIPTION	MODEL#	STANDARD FABRIC GRADES											
		COM	2	3	4	5	6	7	8	9	10	11	12
	<b>GC3031</b>	<b>\$756</b>	<b>\$790</b>	<b>\$824</b>	<b>\$871</b>	<b>\$935</b>	<b>\$960</b>	<b>\$1016</b>	<b>\$1125</b>	<b>\$1177</b>	<b>\$1278</b>	<b>\$1416</b>	<b>\$1588</b>
		OVERALL DIMENSIONS			SEAT DIMENSIONS			BACK DIMENSIONS					
		W	D	H	W	D	H	W	H				
<b>Frolick Stacking Armchair</b> 4 Leg Base, Rectangular back COM Yardage: 1.25 Freight Class: 250 Product Weight (lbs.): 24 Cubic Feet Per Carton: 6.67		Active weight 300 lbs. Single piece back with pullover style upholstery cover with <b>exposed support brackets</b> on the outer back. Stacks 5 high on floor.	25	24.5	36	19	18	18.5	19.5	17			

DESCRIPTION	MODEL#	STANDARD FABRIC GRADES											
		COM	2	3	4	5	6	7	8	9	10	11	12
	<b>GC3032</b>	<b>\$721</b>	<b>\$758</b>	<b>\$791</b>	<b>\$838</b>	<b>\$903</b>	<b>\$927</b>	<b>\$984</b>	<b>\$1093</b>	<b>\$1145</b>	<b>\$1245</b>	<b>\$1384</b>	<b>\$1557</b>
		OVERALL DIMENSIONS			SEAT DIMENSIONS			BACK DIMENSIONS					
		W	D	H	W	D	H	W	H				
<b>Frolick Stacking Chair</b> Armless, 4 Leg Base, Rectangular back COM Yardage: 1.25 Freight Class: 250 Product Weight (lbs.): 21 Cubic Feet Per Carton: 6.67		Active weight 300 lbs. Single piece back with pullover style upholstery cover with <b>exposed support brackets</b> on the outer back. Stacks 5 high on floor.	21	24.5	36	19	18	18.5	19.5	17			

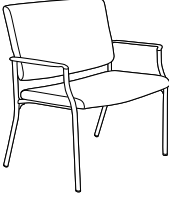
DESCRIPTION	MODEL#	STANDARD FABRIC GRADES											
		COM	2	3	4	5	6	7	8	9	10	11	12
	<b>GC3033</b>	<b>\$1380</b>	<b>\$1446</b>	<b>\$1505</b>	<b>\$1587</b>	<b>\$1704</b>	<b>\$1748</b>	<b>\$1851</b>	<b>\$2044</b>	<b>\$2143</b>	<b>\$2323</b>	<b>\$2572</b>	<b>\$2881</b>
		OVERALL DIMENSIONS			SEAT DIMENSIONS			BACK DIMENSIONS					
		W	D	H	W	D	H	W	H				
<b>Frolick Bariatric Stacking Armchair</b> 4 Leg Base, Rectangular back COM Yardage: 1.25 Freight Class: 300 Product Weight (lbs.): 42 Cubic Feet Per Carton: 26.5		Active weight 500 lbs. Single piece back with pullover style upholstery cover with <b>exposed support brackets</b> on the outer back. Stacks 2 high.	37	24.5	36.5	31.5	18	18.5	32	18.5			

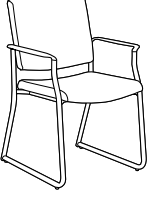



DESCRIPTION	MODEL#	STANDARD FABRIC GRADES											
		COM	2	3	4	5	6	7	8	9	10	11	12
	<b>GC3034</b>	<b>\$783</b>	<b>\$820</b>	<b>\$852</b>	<b>\$899</b>	<b>\$964</b>	<b>\$988</b>	<b>\$1045</b>	<b>\$1153</b>	<b>\$1205</b>	<b>\$1307</b>	<b>\$1445</b>	<b>\$1617</b>
		OVERALL DIMENSIONS			SEAT DIMENSIONS			BACK DIMENSIONS					
		W	D	H	W	D	H	W	H				
<b>Frolick Armchair</b> Sled Base, Rectangular back COM Yardage: 1.25 Freight Class: 250 Product Weight (lbs.): 32 Cubic Feet Per Carton: 13.75		Active weight 300 lbs. Single piece back with pullover style upholstery cover with <b>exposed support brackets</b> on the outer back. <b>Does not stack.</b>	25	24.5	36	18	17	18.5	18.75	18			

DESCRIPTION	MODEL#	STANDARD FABRIC GRADES											
		COM	2	3	4	5	6	7	8	9	10	11	12
	<b>GC3035</b>	<b>\$751</b>	<b>\$785</b>	<b>\$819</b>	<b>\$866</b>	<b>\$929</b>	<b>\$954</b>	<b>\$1011</b>	<b>\$1120</b>	<b>\$1172</b>	<b>\$1272</b>	<b>\$1410</b>	<b>\$1583</b>
		OVERALL DIMENSIONS			SEAT DIMENSIONS			BACK DIMENSIONS					
		W	D	H	W	D	H	W	H				
<b>Frolick Armless Chair</b> Sled Base, Rectangular back COM Yardage: 1.25 Freight Class: 250 Product Weight (lbs.): 30 Cubic Feet Per Carton: 13.75		Active weight 300 lbs. Single piece back with pullover style upholstery cover with <b>exposed support brackets</b> on the outer back. <b>Does not stack.</b>	21	24.5	36	19	18	18.5	19.5	17			

# SEATING

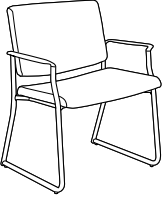
# FROLICK™ & SPLASH™

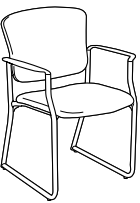
F

DESCRIPTION	MODEL#	STANDARD FABRIC GRADES											
		COM	2	3	4	5	6	7	8	9	10	11	12
 <p><b>Frolick</b>  <b>Bariatric Armchair</b> Sled Base, Rectangular back                      COM Yardage: 2.25                      Freight Class: 300                      Product Weight (lbs.): 47                      Cubic Feet Per Carton: 26.5</p>	<b>GC3036</b>	\$1467	\$1533	\$1593	\$1674	\$1793	\$1836	\$1941	\$2131	\$2230	\$2411	\$2660	\$2970
	<b>OVERALL DIMENSIONS</b>			<b>SEAT DIMENSIONS</b>			<b>BACK DIMENSIONS</b>						
	<b>W</b>	<b>D</b>	<b>H</b>	<b>W</b>	<b>D</b>	<b>H</b>	<b>W</b>	<b>H</b>					
	37	24.5	36.5	31.5	18	18.5	32	18.5					
<p>Active weight 500 lbs.                      Single piece back with pullover style upholstery cover with <b>exposed support brackets</b> on the outer back.</p> <p><b>Does not stack.</b></p>													
 <p><b>Splash</b>  <b>Stacking Armchair</b> 4 Leg Base, Fan back with concealed attachment                      COM Yardage: 1.25                      Freight Class: 250                      Product Weight (lbs.): 25.33                      Cubic Feet Per Carton: 6.67</p>	<b>GC3011</b>	\$756	\$790	\$824	\$871	\$935	\$960	\$1016	\$1125	\$1177	\$1278	\$1416	\$1588
	<b>OVERALL DIMENSIONS</b>			<b>SEAT DIMENSIONS</b>			<b>BACK DIMENSIONS</b>						
	<b>W</b>	<b>D</b>	<b>H</b>	<b>W</b>	<b>D</b>	<b>H</b>	<b>W</b>	<b>H</b>					
	25	24.25	35.5	19.5	18.5	18.5	20	17.5					
<p>Active weight 300 lbs.                      Stacks 5 high on floor.</p>													
 <p><b>Splash</b>  <b>Stacking Chair</b> Armless, 4 Leg Base, Fan back with concealed attachment                      COM Yardage: 1.25                      Freight Class: 250                      Product Weight (lbs.): 22.33                      Cubic Feet Per Carton: 6.67</p>	<b>GC3012</b>	\$721	\$758	\$791	\$838	\$903	\$927	\$984	\$1093	\$1145	\$1245	\$1384	\$1557
	<b>OVERALL DIMENSIONS</b>			<b>SEAT DIMENSIONS</b>			<b>BACK DIMENSIONS</b>						
	<b>W</b>	<b>D</b>	<b>H</b>	<b>W</b>	<b>D</b>	<b>H</b>	<b>W</b>	<b>H</b>					
	21	24.25	35.5	19.5	18.5	18.5	20	17.5					
<p>Active weight 300 lbs.                      Stacks 5 high on floor.</p>													
 <p><b>Splash</b>  <b>Side Chair</b> Sled Base, Fan back with concealed attachment                      COM Yardage: 1.25                      Freight Class: 250                      Product Weight (lbs.): 34                      Cubic Feet Per Carton: 17</p>	<b>GC3013</b>	\$783	\$820	\$852	\$899	\$964	\$988	\$1045	\$1153	\$1205	\$1307	\$1445	\$1617
	<b>OVERALL DIMENSIONS</b>			<b>SEAT DIMENSIONS</b>			<b>BACK DIMENSIONS</b>						
	<b>W</b>	<b>D</b>	<b>H</b>	<b>W</b>	<b>D</b>	<b>H</b>	<b>W</b>	<b>H</b>					
	25	24.25	35.5	19.5	18.5	18.5	20	17.5					
<p>Active weight 300 lbs.</p> <p><b>Does not stack.</b></p>													
 <p><b>Splash</b>  <b>Side Chair</b> Sled Base, Fan back with concealed attachment                      COM Yardage: 1.25                      Freight Class: 250                      Product Weight (lbs.): 32                      Cubic Feet Per Carton: 13.75</p>	<b>GC3014</b>	\$751	\$785	\$819	\$866	\$929	\$954	\$1011	\$1120	\$1172	\$1272	\$1410	\$1583
	<b>OVERALL DIMENSIONS</b>			<b>SEAT DIMENSIONS</b>			<b>BACK DIMENSIONS</b>						
	<b>W</b>	<b>D</b>	<b>H</b>	<b>W</b>	<b>D</b>	<b>H</b>	<b>W</b>	<b>H</b>					
	21	24.25	35.5	19.5	18.5	18.5	20	17.5					
<p>Active weight 300 lbs.</p> <p><b>Does not stack.</b></p>													

DESCRIPTION	MODEL#	STANDARD FABRIC GRADES							
		LIST PRICE							
	GC3010	\$337							
		OVERALL DIMENSIONS			SEAT DIMENSIONS			BACK DIMENSIONS	
		W	D	H	W	D	H	W	H
		0	0	0					

**Dolly for Frolick and Splash standard size, four leg chairs**

COM Yardage: --  
 Freight Class: 150  
 Product Weight (lbs.): 16  
 Cubic Feet Per Carton: 3.8

**Allows chairs to stack up to 8 high.**

**DESCRIPTION** **MODEL#** **STANDARD FABRIC GRADES**

**GALA II**

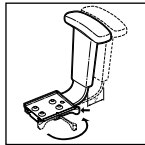

**Vari-Width (WA)** width adjustable arm extensions are standard.

model GC13012, medium back

**Synchro-tilter mechanism (-0)**

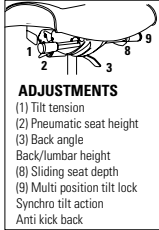

**ADJUSTMENTS**

- (1) Tilt tension
- (2) Pneumatic seat height
- (3) Back angle
- Back/lumbar height
- (8) Sliding seat depth
- (9) Multi position tilt lock
- Synchro tilt action
- Anti kick back

**Ergonomic features:**

A, B, C, D, E, G, H, L, M, N, Q, R, U

**STANDARD FEATURES**

- Gala II is designed to provide exceptional support and comfort throughout the work day.
- Vertical back height ratchet adjustment of 5.25" is standard.
- Back support upright is 3" wide for extra strength.
- One-piece curved back features a pull over style upholstery cover for easy housekeeping and infection prevention practices.
- Standard with Global's high quality Soft Descent™ pneumatic lift which slowly and gently lowers the seat height of the chair making it easy to obtain the exact seat height you desire.
- Standard with height adjustable arms (3B) with self-skinned urethane (SSU) armcaps.
- Vari-Width (WA) width adjustable arm extensions are standard. Allows the arms to move away from the seat by 2" on each side to accommodate various users.
- Waterfall seamless seat front design with high density Ultracell foam for superior comfort and longevity
- Underside of seat pan is completely sealed for ease of cleaning.
- Side activated sliding seat depth adjustment (MD) is standard on synchro-tilter.
- Five prong, injection molded, fiberglass reinforced nylon Black base with dual wheel carpet casters (C65).
- For Globalcare textiles and finish options, visit the website at [globalfurnituregroup.com](http://globalfurnituregroup.com).
- Can be upholstered in standard Global textiles if Healthcare compliance is not required.
- To meet higher standards for housekeeping and infection control, Gala II has a seamless seat and one stitch pull over back upholstery, while still offering soft curves to the design. Note: Vinyl and woven treated textiles are thicker in nature and will experience wrinkles on some curves or corners as a result.

**OPTIONAL FEATURES**

- Optional hard floor casters (C65R) are available. Add \$66.

**SUGGESTED APPLICATIONS**

- Office/Meeting
- Caregiver Workstations

**DESCRIPTION** **MODEL#** **STANDARD FABRIC GRADES**



**Medium Back Synchro-Tilter**

COM Yardage: 1.9  
 Freight Class: 150  
 Product Weight (lbs.): 53  
 Cubic Feet Per Carton: 10.5

MODEL#	COM	2	3	4	5	6	7	8	9	10	11	12
GC13012	\$954	\$1018	\$1077	\$1156	\$1273	\$1327	\$1430	\$1596	\$1726	\$1868	\$2160	\$2473

OVERALL DIMENSIONS			SEAT DIMENSIONS			BACK DIMENSIONS	
W	D	H	W	D	H	W	H
24.5	23.5	39	20.5	17-18	16.5-21.5	20	20.5



GC BEACH



model GC4077



model GC4078

STANDARD FEATURES

- Elegant wood seating with a choice of an upholstered or vertical wood slat back.
- Frame construction is beech hardwood.
- Legs are equipped with White non-marking polypropylene glides. Suitable for both carpet and hard surface flooring.
- All cushions are fixed and non-removable.
- Cushions are made with highly resilient foam and seats are equipped with a synthetic rubberized webbing suspension system for extra comfort
- Seat cushion underside is finished with Black polyurethane
- Does not stack
- For Globalcare textiles and finish options, visit the website at [globalfurnituregroup.com](http://globalfurnituregroup.com).
- Can be upholstered in standard Global textiles if Healthcare compliance is not required.

OPTIONAL FEATURES

- Wood frame available in Absolute (AAM), Black (BKM), Cherry (ACM), English Oak (EOM), Espresso Cafe (ECM), Fruitwood (TFM), Gray (HGM), Honey (AHM), Mahogany (TMM), Maple (AVM), Medium Walnut (MWM), Natural Walnut (NLW), Night (ASM), Noce Biondo (NBM), Noce Grigio (NGM), Noce Leggero (NEM), Noce Medio (NMM), Sandy Beach (SKM), Shaker Cherry (SKM), Silver Oak (SOM), Walnut (TWM), WC Cream (WTM), White (WHM) and Winter Cherry (WCM). Please specify.
- For moisture barrier on seat, please specify **(MB)**. - Add \$119 per seat.

SUGGESTED APPLICATIONS

- Dining/Cafeteria
- Guest seating
- Lobbies
- Lounge/Waiting
- Office/Meeting
- Patient rooms
- Resident rooms

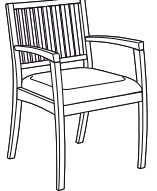
DESCRIPTION	MODEL#	STANDARD FABRIC GRADES											
		COM	2	3	4	5	6	7	8	9	10	11	12
 <p><b>Armchair w/Upholstered Back</b> COM Yardage: 1 Freight Class: 300 Product Weight (lbs.): 20 Cubic Feet Per Carton: 13.25</p>	GC4077	\$884	\$914	\$940	\$978	\$1034	\$1060	\$1111	\$1186	\$1249	\$1317	\$1451	\$1601
		OVERALL DIMENSIONS			SEAT DIMENSIONS			BACK DIMENSIONS					
		W	D	H	W	D	H	W	H				
			22	22.25	33.5	19.5	18.5	18.75	19.5	15.5			
 <p><b>Armchair w/Vertical Wood Slat Back</b> COM Yardage: 1 Freight Class: 300 Product Weight (lbs.): 20 Cubic Feet Per Carton: 13.25</p>	GC4078	\$909	\$939	\$965	\$1003	\$1059	\$1085	\$1136	\$1217	\$1274	\$1342	\$1488	\$1638
		OVERALL DIMENSIONS			SEAT DIMENSIONS			BACK DIMENSIONS					
		W	D	H	W	D	H	W	H				
			22	22.25	33.5	19.5	19	18.75	19.5	15.5			

## GC-BELONG



model GC4231HB

model GC4231HB

## STANDARD FEATURES

- The GC Belong series was developed for active and transient spaces and environments with rigorous demands.
- Elliptical metal tube frame is available in Black (BLK), Kalua (KAL), Latte (LAB), Mocha (J52), Shadow (SHW), Toast (TOA) and Tungsten (TUN). Specify finish.
- Self-skinned urethane (SSU) armcaps are available in Black (BLK), Kalua (KAL), Latte (LAB), Mocha (J52), Shadow (SHW), and Toast (TOA).
- Wood armcaps are also available in Absolute (AAM), Black (BKM), Cherry (ACM), English Oak (EOM), Espresso Cafe (ECM), Fruitwood (TFM), Gray (HGM), Honey (AHM), Mahogany (TMM), Maple (AVM), Medium Walnut (MWM), Natural Walnut (NLW), Night (ASM), Noce Biondo (NBM), Noce Grigio (NGM), Noce Leggero (NEM), Noce Medio (NMM), Sandy Beach (SKM), Shaker Cherry (SKM), Silver Oak (SOM), Walnut (TWM), WC Cream (WTM), White (WHM) and Winter Cherry (WCM). Refer to individual models for upcharge.
- The frame can be weighted and made with tamperproof fasteners for greater security in more challenging mental health spaces or correctional facilities.
- Active weight capacity is 500 lbs. per seat position; 750 lbs. for bariatric seating.
- The seat and back are removable and field replaceable.
- For added comfort, seats are standard with high density Ultracell foam.
- All seat frames feature a wallsaver design to prevent back contact with wall. **Note:** In order to allow full flex of the back on models GC4242, GC4242HB, GC4243 and GC4243HB, a 10.5" wall clearance is required.
- Ottomans and Benches do not have wallsaver legs.
- Standard seat height on all models is 18.5"
- Seat height on GC4231-24 and GC4241-24 is 24"
- Standard with Black glides
- Select models are offered with casters on the rear legs. These casters allow for ease of movement in support of housekeeping efforts or repositioning seating within a space. **They are not intended for patient transfer.**

- Clean out space is provided between the seat and back cushions for easier housekeeping.
- **Left and Right position reference** is determined from the seated position.
- Flex back models feature a torsion control mechanism which allows the back to move 14° in a soothing rocking motion.
- For Globalcare textiles and wood finish options, visit the website at [globalfurnituregroup.com](http://globalfurnituregroup.com)
- Can be upholstered in standard Global textiles if healthcare compliance is not required.

## OPTIONAL FEATURES

- For hardsurface floors, specify opaque, non-marking glides (NM). No upcharge.
- For moisture barrier on seat, specify (MB). Add \$119 per seat. For bariatric models, Add \$183 per seat.
- As an option, seams can be sealed to prevent penetration of fluids through the stitching. Contact Customer Care for approved textiles.  
Low Back Models - **Add \$104** list upcharge per seat  
Low Back Bariatric Models - **Add \$111** list upcharge per seat  
High Back Models - **Add \$113** list upcharge per seat  
High Back Bariatric Models - **Add \$120** list upcharge per seat  
Split-Back Models - **Add \$166** list upcharge per seat  
Ottoman - **Add \$37** list upcharge  
Benches: **Add \$45** list upcharge for one seat, **Add \$98** for two seat models, and **Add \$146** for three seat models.
- Complementary tables are offered as part of this series in either high pressure or thermally fused laminate tops.

## SUGGESTED APPLICATIONS

- Bariatric seating
- Guest seating
- Lobbies
- Lounge/Waiting
- Patient/Resident rooms
- Treatment/Exam rooms

## GC BELONG BENCHES &amp; BRIDGES

- Units with links can only gang with a bridge. They CANNOT gang directly with another link unit. (Link units have side brackets.)
- Available in one, two or three seat models.
- A bridge unit suspends between 2 other units using their links. A bridge is NOT freestanding. (A bridge does not have legs.)
- Benches have no front or back facing distinction so models with links can be reversed.
- All bridge models can be ganged to seat units with link.

## GC BELONG TABLES

- Table heights are 16"
- 1" thick tops are available in thermally fused laminate (LP) and high pressure laminate (HP). Please select the appropriate model number for the finish you prefer.
- 2mm edging color coordinated with laminate finish is standard for all tops. Finish must be specified at the time of order.
- Refer to the following lists when selecting a finish color. Must specify both a top color and leg finish when ordering.

## Thermally Fused Laminate (LP)

Absolute Acajou (ACJ)  
Asian Night (ASN)  
Avant Cherry (AWC)  
Avant Honey (AWH)  
Brushed Cobalt (BRC)  
Clear Maple (CMB)  
Dark Espresso (DES)  
Designer White (DWT)  
Hayden Grey (HGT)  
Noce Biondo (NBL)  
Noce Grigio (NGL)  
Noce Leggero (NEL)  
Noce Medio (NML)  
Quartered Mahogany (QTM)  
Tiger Fruitwood (TFW)  
Tiger Walnut (TWL)  
Walnut Heights (WHE)  
White Chocolate (WCH)  
Winter Cherry (WCR)

## High Pressure Laminate (HP)

Absolute Acajou (ACJ)  
Asian Night (ASN)  
Avant Cherry (W357)  
Avant Honey (W356)  
Brushed Cobalt (BRC)  
Clear Maple (CMB)  
Dark Espresso (W142)  
Designer White (DWT)  
Hayden Grey (HGT)  
Noce Biondo (NBL)  
Noce Grigio (NGL)  
Noce Leggero (NEL)  
Noce Medio (NML)  
Quartered Mahogany (QTM)  
Tiger Fruitwood (TFW)  
Tiger Walnut (W819)  
Walnut Heights (WHE)  
White Chocolate (WCH)  
Winter Cherry (WCR)

**LOW BACK**

	GC4230	GC4231	GC4232	GC4234	GC4233	GC4235	GC4236
Freestanding units							
Ganging units with link on Left side	GC4230L 	GC4231L 	GC4232L 	GC4234L 	GC4233L 	GC4235L 	GC4236L 
Ganging units with link on Right side	GC4230R 	GC4231R 	GC4232R 	GC4234R 	GC4233R 	GC4235R 	GC4236R 
Ganging units with links on Both sides	GC4230B 	GC4231B 	GC4232B 	GC4234B 	GC4233B 	GC4235B 	GC4236B 

**HIGH BACK**

	GC4230HB	GC4231HB	GC4232HB	GC4234HB	GC4233HB	GC4235HB	GC4236HB
Freestanding units							
Ganging units with link on Left side	GC4230HBL 	GC4231HBL 	GC4232HBL 	GC4234HBL 	GC4233HBL 	GC4235HBL 	GC4236HBL 
Ganging units with link on Right side	GC4230HBR 	GC4231HBR 	GC4232HBR 	GC4234HBR 	GC4233HBR 	GC4235HBR 	GC4236HBR 
Ganging units with links on Both sides	GC4230HBB 	GC4231HBB 	GC4232HBB 	GC4234HBB 	GC4233HBB 	GC4235HBB 	GC4236HBB 

Non ganging units with casters



Ganging Bariatric units with link on Both side



Non ganging Bariatric units



Non ganging Flexback units



Non ganging Split Back units



Ganging Bariatric units with link on Left side



Non ganging Flexback units with casters



Non ganging Split Back units with casters



Ganging Bariatric units with link on Right side



Hip Height Chair with wedged cushion, 24" Seat Height



**BENCHES & BRIDGES**

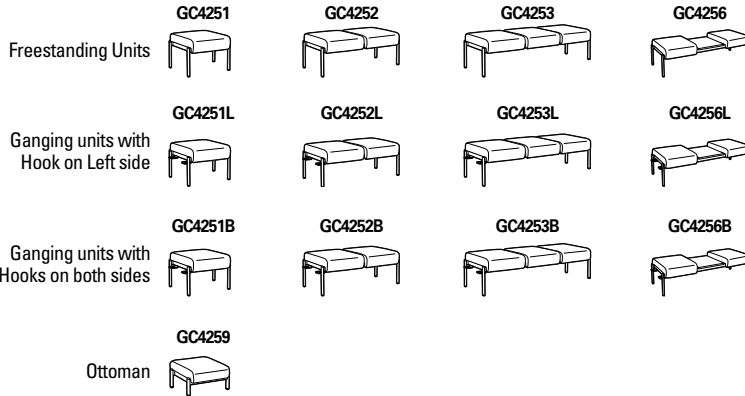

**TABLES**

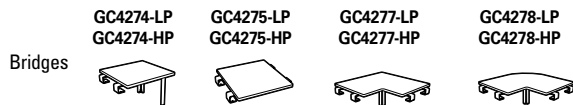
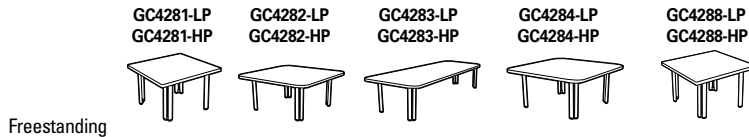

- A bridge unit suspends between 2 other units with legs and is supported by their linking brackets
- A bridge unit is **not** freestanding and cannot be made freestanding
- Units with legs and links can only gang with a bridge. They **cannot** gang directly with another link unit with legs
- Bridges **cannot** gang directly with another bridge

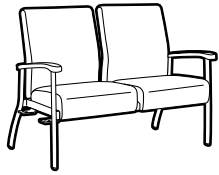

1, 2 or 3 seat chair with integrated ganging bracket

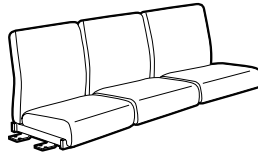

Any seating bridge unit connects to:

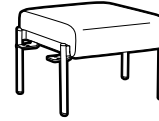

1, 2 or 3 seat bench with integrated ganging bracket



1, 2 or 3 seat chair with integrated ganging bracket



Any table bridge unit connects to:

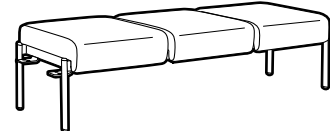

1, 2 or 3 seat bench with integrated ganging bracket

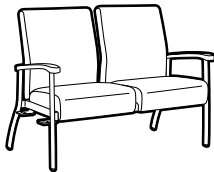

1, 2 or 3 seat chair with integrated ganging bracket



**CANNOT connect to**



1, 2 or 3 seat chair with integrated ganging bracket



Any table bridge unit



**CANNOT connect to**

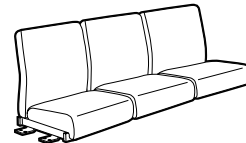

Any seating bridge unit



Any seating bridge unit



**CANNOT connect to**

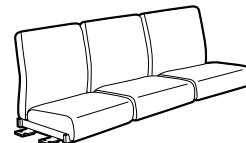

Any seating bridge unit



Any table bridge unit



**CANNOT connect to**

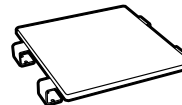

Any table bridge unit

PACKAGE 1



Description  
Low Back Three Seat Chair

Qty	Model Number	Dimensions	Ydg.	Freight Class	Wt./Lbs.	Cu. Ft.	List Price
4	GC4235	26 x 74.5 x 37.5	5	250	142	65.25	\$4211

**PACKAGE TOTAL** **\$16,844**  
 (\*Please Note: List Prices shown are for the standard Grade 2 vinyl/standard finishes.)

PACKAGE 2



Description  
Low Back Three Seat Chair  
Low Back Armchair, Left  
Low Back Armchair, Right  
End Corner Table Bridge

Qty	Model Number	Dimensions	Ydg.	Freight Class	Wt./Lbs.	Cu. Ft.	List Price
1	GC4233B	26 x 72.75 x 37.5	5	250	134	65.25	\$3725
1	GC4231L	28 x 26.5 x 37.5	1.75	250	53.5	20.25	\$1713
1	GC4231R	28 x 26.5 x 37.5	1.75	250	53.5	20.25	\$1713
2	GC4277-HP	35 x 35 x 16	--	125	45	6	\$936

**PACKAGE TOTAL** **\$9023**  
 (\* Please Note: List Prices shown are for the standard Grade 2 vinyl/standard laminate.)

PACKAGE 3



Description  
Low Back Armless Chair  
Low Back Armless Chair, Right  
Low Back Armless Chair, Left  
End Corner Table Bridge

Qty	Model Number	Dimensions	Ydg.	Freight Class	Wt./Lbs.	Cu. Ft.	List Price
2	GC4230B	28 x 26.75 x 37.5	1.75	250	45.5	20.25	\$1421
1	GC4230R	28 x 25.75 x 37.5	1.75	250	45.5	20.25	\$1378
1	GC4230L	28 x 25.75 x 37.5	1.75	250	45.5	20.25	\$1378
3	GC4277-HP	35 x 35 x 16	--	125	45	6	\$936

**PACKAGE TOTAL** **\$8406**  
 (\* Please Note: List Prices shown are for the standard Grade 2 vinyl/standard laminate.)

PACKAGE 4



Description  
Low Back Three Seat Chair  
Bariatric Low Back Armchair, Left  
Low Back Armchair, Left  
Low Back Armchair, Right  
End Corner Table Bridge  
Rectangular Coffee Table  
Square Table Top

Qty	Model Number	Dimensions	Ydg.	Freight Class	Wt./Lbs.	Cu. Ft.	List Price
1	GC4235R	26 x 74.5 x 37.5	5	250	143	65.25	\$4254
1	GC4241L	28 x 37.5 x 37.5	3	250	71	30.5	\$2234
1	GC4231L	28 x 26.5 x 37.5	1.75	250	53.5	20.25	\$1713
1	GC4231R	28 x 26.5 x 37.5	1.75	250	53.5	20.25	\$1713
1	GC4277-HP	35 x 35 x 16	--	125	45	6	\$936
1	GC4283-HP	54 x 22 x 16	--	125	37	6	\$1347
1	GC4275-HP	23 x 23 x 1	--	150	18	3.4	\$579

**PACKAGE TOTAL** **\$12,776**  
 (\* Please Note: List Prices shown are for the standard Grade 2 vinyl/standard laminate.)

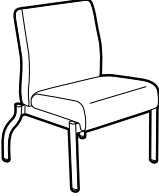
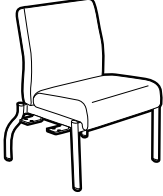
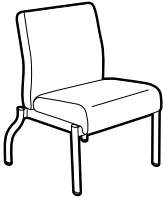
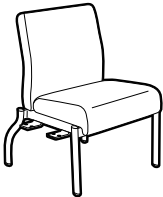
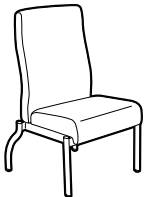
DESCRIPTION	MODEL#	STANDARD FABRIC GRADES											
		COM	2	3	4	5	6	7	8	9	10	11	12
	GC4230	\$1281	\$1334	\$1382	\$1450	\$1544	\$1581	\$1665	\$1822	\$1901	\$2047	\$2250	\$2502
		OVERALL DIMENSIONS			SEAT DIMENSIONS			BACK DIMENSIONS					
		W	D	H	W	D	H	W	H				
Active weight 500 lbs.		24.75	28	37.5	22	18	18	21.5	19.5				
	GC4230R	\$1322	\$1378	\$1424	\$1493	\$1587	\$1624	\$1708	\$1865	\$1945	\$2090	\$2293	\$2544
		OVERALL DIMENSIONS			SEAT DIMENSIONS			BACK DIMENSIONS					
		W	D	H	W	D	H	W	H				
Active weight 500 lbs.		25.75	28	37.5	22	18	18	21.5	19.5				
	GC4230L	\$1322	\$1378	\$1424	\$1493	\$1587	\$1624	\$1708	\$1865	\$1945	\$2090	\$2293	\$2544
		OVERALL DIMENSIONS			SEAT DIMENSIONS			BACK DIMENSIONS					
		W	D	H	W	D	H	W	H				
Active weight 500 lbs.		25.75	28	37.5	22	18	18	21.5	19.5				
	GC4230B	\$1365	\$1421	\$1467	\$1535	\$1630	\$1667	\$1749	\$1908	\$1986	\$2133	\$2337	\$2587
		OVERALL DIMENSIONS			SEAT DIMENSIONS			BACK DIMENSIONS					
		W	D	H	W	D	H	W	H				
Active weight 500 lbs.		26.75	28	37.5	22	18	18	21.5	19.5				
	GC4230HB	\$1347	\$1409	\$1460	\$1541	\$1648	\$1689	\$1785	\$1964	\$2056	\$2223	\$2455	\$2740
		OVERALL DIMENSIONS			SEAT DIMENSIONS			BACK DIMENSIONS					
		W	D	H	W	D	H	W	H				
Active weight 500 lbs.		24.75	28	42.5	22	18	18	21.5	24.5				

**Low Back Chair** Armless  
COM Yardage: 1.75  
Freight Class: 250  
Product Weight (lbs.): 45.5  
Cubic Feet Per Carton: 20.25

**Low Back Chair** Armless, Right  
COM Yardage: 1.75  
Freight Class: 250  
Product Weight (lbs.): 45.5  
Cubic Feet Per Carton: 20.25

**Low Back Chair** Armless, Left  
COM Yardage: 1.75  
Freight Class: 250  
Product Weight (lbs.): 45.5  
Cubic Feet Per Carton: 20.25

**Low Back Chair** Armless, Left & Right  
COM Yardage: 1.75  
Freight Class: 250  
Product Weight (lbs.): 45.5  
Cubic Feet Per Carton: 20.25

**High Back Chair** Armless  
COM Yardage: 2  
Freight Class: 250  
Product Weight (lbs.): 49.5  
Cubic Feet Per Carton: 20.25

# SEATING

# GC-BELONG

G

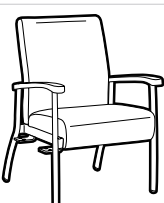
DESCRIPTION	MODEL#	STANDARD FABRIC GRADES											
		COM	2	3	4	5	6	7	8	9	10	11	12
 <b>High Back Chair</b> Armless, Right COM Yardage: 2 Freight Class: 250 Product Weight (lbs.): 49.5 Cubic Feet Per Carton: 20.25	<b>GC4230HBR</b>	\$1391	\$1453	\$1504	\$1585	\$1691	\$1734	\$1829	\$2008	\$2100	\$2265	\$2500	\$2785
		OVERALL DIMENSIONS			SEAT DIMENSIONS			BACK DIMENSIONS					
		W	D	H	W	D	H	W	H				
		25.75	28	42.5	22	18	18	21.5	24.5				
 <b>High Back Chair</b> Armless, Left COM Yardage: 2 Freight Class: 250 Product Weight (lbs.): 49.5 Cubic Feet Per Carton: 20.25	<b>GC4230HBL</b>	\$1391	\$1453	\$1504	\$1585	\$1691	\$1734	\$1829	\$2008	\$2100	\$2265	\$2500	\$2785
		OVERALL DIMENSIONS			SEAT DIMENSIONS			BACK DIMENSIONS					
		W	D	H	W	D	H	W	H				
		25.75	28	42.5	22	18	18	21.5	24.5				
 <b>High Back Chair</b> Armless, Left & Right COM Yardage: 2 Freight Class: 250 Product Weight (lbs.): 51.5 Cubic Feet Per Carton: 20.25	<b>GC4230HBB</b>	\$1434	\$1496	\$1549	\$1625	\$1735	\$1777	\$1872	\$2053	\$2141	\$2310	\$2542	\$2828
		OVERALL DIMENSIONS			SEAT DIMENSIONS			BACK DIMENSIONS					
		W	D	H	W	D	H	W	H				
		26.75	28	42.5	22	18	18	21.5	24.5				
 <b>Low Back Armchair</b> COM Yardage: 1.75 Freight Class: 250 Product Weight (lbs.): 53.5 Cubic Feet Per Carton: 20.25	<b>GC4231</b>	\$1560	\$1614	\$1660	\$1729	\$1824	\$1859	\$1944	\$2101	\$2179	\$2328	\$2530	\$2780
		OVERALL DIMENSIONS			SEAT DIMENSIONS			BACK DIMENSIONS					
		W	D	H	W	D	H	W	H				
		26.5	28	37.5	22	18	18	21.5	19.5				
 <b>Low Back Armchair</b> Right COM Yardage: 1.75 Freight Class: 250 Product Weight (lbs.): 53.5 Cubic Feet Per Carton: 20.25	<b>GC4231R</b>	\$1657	\$1713	\$1759	\$1828	\$1922	\$1959	\$2043	\$2201	\$2280	\$2426	\$2629	\$2879
		OVERALL DIMENSIONS			SEAT DIMENSIONS			BACK DIMENSIONS					
		W	D	H	W	D	H	W	H				
		26.5	28	37.5	22	18	18	21.5	19.5				

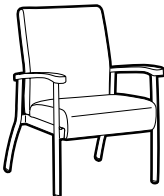

DESCRIPTION	MODEL#	STANDARD FABRIC GRADES											
		COM	2	3	4	5	6	7	8	9	10	11	12
 <p><b>Low Back Armchair Left</b> COM Yardage: 1.75 Freight Class: 250 Product Weight (lbs.): 53.5 Cubic Feet Per Carton: 20.25</p>	<b>GC4231L</b>	\$1657	\$1713	\$1759	\$1828	\$1922	\$1959	\$2043	\$2201	\$2280	\$2426	\$2629	\$2879
	<p>Active weight 500 lbs. Wood armcap option - <b>Add \$165</b></p>												
		<b>OVERALL DIMENSIONS</b> W D H			<b>SEAT DIMENSIONS</b> W D H			<b>BACK DIMENSIONS</b> W H					
		26.5	28	37.5	22	18	18	21.5	19.5				

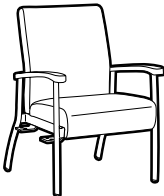
DESCRIPTION	MODEL#	STANDARD FABRIC GRADES											
		COM	2	3	4	5	6	7	8	9	10	11	12
 <p><b>Low Back Armchair Left &amp; Right</b> COM Yardage: 1.75 Freight Class: 250 Product Weight (lbs.): 53.5 Cubic Feet Per Carton: 20.25</p>	<b>GC4231B</b>	\$1699	\$1755	\$1801	\$1871	\$1964	\$2001	\$2085	\$2243	\$2320	\$2468	\$2671	\$2923
	<p>Active weight 500 lbs. Wood armcap option - <b>Add \$165</b></p>												
		<b>OVERALL DIMENSIONS</b> W D H			<b>SEAT DIMENSIONS</b> W D H			<b>BACK DIMENSIONS</b> W H					
		26.5	28	37.5	22	18	18	21.5	19.5				

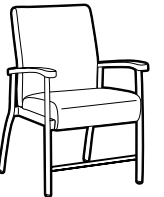
DESCRIPTION	MODEL#	STANDARD FABRIC GRADES											
		COM	2	3	4	5	6	7	8	9	10	11	12
 <p><b>Low Back Armchair Post Surgery.</b> Designed to immobilize the pelvis and hip joints after surgery. COM Yardage: 1.75 Freight Class: 250 Product Weight (lbs.): 57.5 Cubic Feet Per Carton: 24.25</p>	<b>GC4231-24</b> 24" Seat Height	\$1861	\$1915	\$1961	\$2029	\$2125	\$2160	\$2245	\$2403	\$2482	\$2628	\$2830	\$3081
	<p>Active weight 500 lbs. Wood armcap option - <b>Add \$165</b></p>												
		<b>OVERALL DIMENSIONS</b> W D H			<b>SEAT DIMENSIONS</b> W D H			<b>BACK DIMENSIONS</b> W H					
		26.5	28.75	43.5	22	18	24	21.5	19.5				

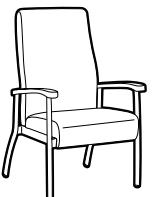
DESCRIPTION	MODEL#	STANDARD FABRIC GRADES											
		COM	2	3	4	5	6	7	8	9	10	11	12
 <p><b>High Back Armchair</b> COM Yardage: 2 Freight Class: 250 Product Weight (lbs.): 58.5 Cubic Feet Per Carton: 20.25</p>	<b>GC4231HB</b>	\$1665	\$1725	\$1781	\$1858	\$1967	\$2009	\$2102	\$2285	\$2374	\$2541	\$2773	\$3059
	<p>Active weight 500 lbs. Wood armcap option - <b>Add \$165</b></p>												
		<b>OVERALL DIMENSIONS</b> W D H			<b>SEAT DIMENSIONS</b> W D H			<b>BACK DIMENSIONS</b> W H					
		26.5	28	42.5	22	18	18	21.5	24.5				

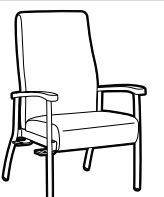
DESCRIPTION	MODEL#	STANDARD FABRIC GRADES											
		COM	2	3	4	5	6	7	8	9	10	11	12
 <p><b>High Back Armchair Right</b> COM Yardage: 2 Freight Class: 250 Product Weight (lbs.): 58.5 Cubic Feet Per Carton: 20.25</p>	<b>GC4231HBR</b>	\$1707	\$1769	\$1822	\$1901	\$2009	\$2050	\$2146	\$2326	\$2416	\$2584	\$2816	\$3101
	<p>Active weight 500 lbs. Wood armcap option - <b>Add \$165</b></p>												
		<b>OVERALL DIMENSIONS</b> W D H			<b>SEAT DIMENSIONS</b> W D H			<b>BACK DIMENSIONS</b> W H					
		26.5	28	42.5	22	18	18	21.5	24.5				

# SEATING

# GC-BELONG

G

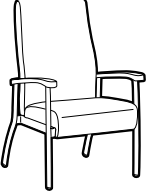
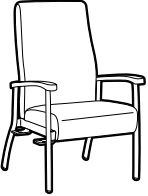
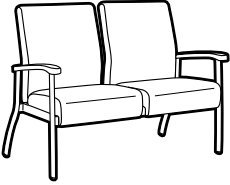
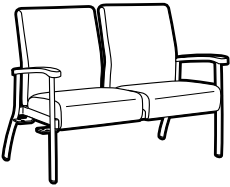
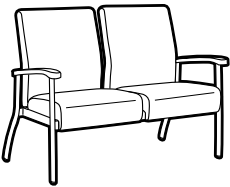
DESCRIPTION	MODEL#	STANDARD FABRIC GRADES											
		COM	2	3	4	5	6	7	8	9	10	11	12
 <p><b>High Back Armchair Left</b> COM Yardage: 2 Freight Class: 250 Product Weight (lbs.): 58.5 Cubic Feet Per Carton: 20.25</p>	<b>GC4231HBL</b>  Active weight 500 lbs. Wood armcap option - <b>Add \$165</b>	\$1707	\$1769	\$1822	\$1901	\$2009	\$2050	\$2146	\$2326	\$2416	\$2584	\$2816	\$3101
		OVERALL DIMENSIONS			SEAT DIMENSIONS			BACK DIMENSIONS					
		W	D	H	W	D	H	W	H				
			26.5	28	42.5	22	18	18	21.5	24.5			
 <p><b>High Back Armchair Left &amp; Right</b> COM Yardage: 2 Freight Class: 250 Product Weight (lbs.): 60.5 Cubic Feet Per Carton: 20.25</p>	<b>GC4231HBB</b>  Active weight 500 lbs. Wood armcap option - <b>Add \$165</b>	\$1749	\$1810	\$1863	\$1942	\$2049	\$2091	\$2186	\$2367	\$2457	\$2624	\$2857	\$3142
		OVERALL DIMENSIONS			SEAT DIMENSIONS			BACK DIMENSIONS					
		W	D	H	W	D	H	W	H				
			26.5	28	42.5	22	18	18	21.5	24.5			
 <p><b>Low Back Two Seat Chair No Center Arm</b> COM Yardage: 3.5 Freight Class: 250 Product Weight (lbs.): 94 Cubic Feet Per Carton: 43</p>	<b>GC4232</b>  Active weight 500 lbs./seat. Wood armcap option - <b>Add \$165</b>	\$2521	\$2630	\$2724	\$2857	\$3048	\$3123	\$3291	\$3605	\$3763	\$4054	\$4461	\$4961
		OVERALL DIMENSIONS			SEAT DIMENSIONS			BACK DIMENSIONS					
		W	D	H	W	D	H	W	H				
			49.75	26	37.5	44	18	18	44	19.5			
 <p><b>Low Back Two Seat Chair No Center Arm, Right</b> COM Yardage: 3.5 Freight Class: 250 Product Weight (lbs.): 95 Cubic Feet Per Carton: 43</p>	<b>GC4232R</b>  Active weight 500 lbs./seat. Wood armcap option - <b>Add \$165</b>	\$2561	\$2672	\$2764	\$2898	\$3089	\$3163	\$3332	\$3645	\$3802	\$4094	\$4502	\$5001
		OVERALL DIMENSIONS			SEAT DIMENSIONS			BACK DIMENSIONS					
		W	D	H	W	D	H	W	H				
			49.75	26	37.5	44	18	18	44	19.5			
 <p><b>Low Back Two Seat Chair No Center Arm, Left</b> COM Yardage: 3.5 Freight Class: 250 Product Weight (lbs.): 95 Cubic Feet Per Carton: 43</p>	<b>GC4232L</b>  Active weight 500 lbs./seat. Wood armcap option - <b>Add \$165</b>	\$2561	\$2672	\$2764	\$2898	\$3089	\$3163	\$3332	\$3645	\$3802	\$4094	\$4502	\$5001
		OVERALL DIMENSIONS			SEAT DIMENSIONS			BACK DIMENSIONS					
		W	D	H	W	D	H	W	H				
			49.75	26	37.5	44	18	18	44	19.5			

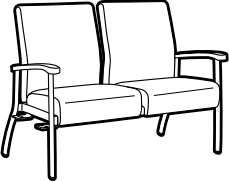
DESCRIPTION	MODEL#	STANDARD FABRIC GRADES											
		COM	2	3	4	5	6	7	8	9	10	11	12
 <p><b>Low Back Two Seat Chair</b> No Center Arm, Left &amp; Right COM Yardage: 3.5 Freight Class: 250 Product Weight (lbs.): 96 Cubic Feet Per Carton: 43</p>	<b>GC4232B</b>	<b>\$2602</b>	<b>\$2713</b>	<b>\$2804</b>	<b>\$2939</b>	<b>\$3131</b>	<b>\$3204</b>	<b>\$3371</b>	<b>\$3686</b>	<b>\$3842</b>	<b>\$4135</b>	<b>\$4541</b>	<b>\$5042</b>
		<b>OVERALL DIMENSIONS</b>			<b>SEAT DIMENSIONS</b>			<b>BACK DIMENSIONS</b>					
		<b>W</b>	<b>D</b>	<b>H</b>	<b>W</b>	<b>D</b>	<b>H</b>	<b>W</b>	<b>H</b>				
		49.75	26	37.5	44	18	18	44	19.5				

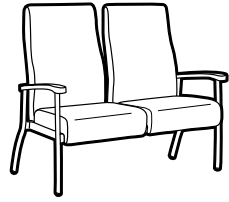
 <p><b>High Back Two Seat Chair</b> No Center Arm COM Yardage: 4 Freight Class: 300 Product Weight (lbs.): 95 Cubic Feet Per Carton: 56.5</p>	<b>GC4232HB</b>	<b>\$2703</b>	<b>\$2829</b>	<b>\$2934</b>	<b>\$3090</b>	<b>\$3306</b>	<b>\$3390</b>	<b>\$3581</b>	<b>\$3941</b>	<b>\$4123</b>	<b>\$4456</b>	<b>\$4920</b>	<b>\$5494</b>
		<b>OVERALL DIMENSIONS</b>			<b>SEAT DIMENSIONS</b>			<b>BACK DIMENSIONS</b>					
		<b>W</b>	<b>D</b>	<b>H</b>	<b>W</b>	<b>D</b>	<b>H</b>	<b>W</b>	<b>H</b>				
		49.75	26	42.5	44	18	18	44	24.5				

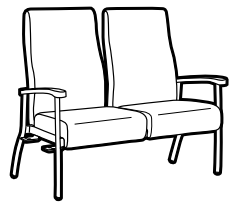
 <p><b>High Back Two Seat Chair</b> No Center Arm, Right COM Yardage: 4 Freight Class: 300 Product Weight (lbs.): 96 Cubic Feet Per Carton: 56.5</p>	<b>GC4232HBR</b>	<b>\$2742</b>	<b>\$2869</b>	<b>\$2975</b>	<b>\$3129</b>	<b>\$3346</b>	<b>\$3429</b>	<b>\$3621</b>	<b>\$3981</b>	<b>\$4162</b>	<b>\$4496</b>	<b>\$4958</b>	<b>\$5532</b>
		<b>OVERALL DIMENSIONS</b>			<b>SEAT DIMENSIONS</b>			<b>BACK DIMENSIONS</b>					
		<b>W</b>	<b>D</b>	<b>H</b>	<b>W</b>	<b>D</b>	<b>H</b>	<b>W</b>	<b>H</b>				
		49.75	26	42.5	44	18	18	44	24.5				

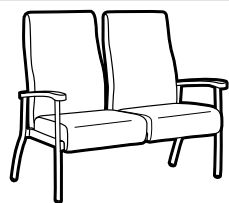
 <p><b>High Back Two Seat Chair</b> No Center Arm, Left COM Yardage: 4 Freight Class: 300 Product Weight (lbs.): 96 Cubic Feet Per Carton: 56.5</p>	<b>GC4232HBL</b>	<b>\$2742</b>	<b>\$2869</b>	<b>\$2975</b>	<b>\$3129</b>	<b>\$3346</b>	<b>\$3429</b>	<b>\$3621</b>	<b>\$3981</b>	<b>\$4162</b>	<b>\$4496</b>	<b>\$4958</b>	<b>\$5532</b>
		<b>OVERALL DIMENSIONS</b>			<b>SEAT DIMENSIONS</b>			<b>BACK DIMENSIONS</b>					
		<b>W</b>	<b>D</b>	<b>H</b>	<b>W</b>	<b>D</b>	<b>H</b>	<b>W</b>	<b>H</b>				
		49.75	26	42.5	44	18	18	44	24.5				

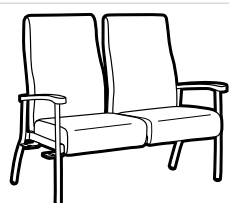
 <p><b>High Back Two Seat Chair</b> No Center Arm, Left &amp; Right COM Yardage: 4 Freight Class: 300 Product Weight (lbs.): 98 Cubic Feet Per Carton: 56.5</p>	<b>GC4232HBB</b>	<b>\$2784</b>	<b>\$2911</b>	<b>\$3015</b>	<b>\$3171</b>	<b>\$3387</b>	<b>\$3470</b>	<b>\$3662</b>	<b>\$4019</b>	<b>\$4203</b>	<b>\$4535</b>	<b>\$4999</b>	<b>\$5572</b>
		<b>OVERALL DIMENSIONS</b>			<b>SEAT DIMENSIONS</b>			<b>BACK DIMENSIONS</b>					
		<b>W</b>	<b>D</b>	<b>H</b>	<b>W</b>	<b>D</b>	<b>H</b>	<b>W</b>	<b>H</b>				
		49.75	26	42.5	44	18	18	44	24.5				

# SEATING

# GC-BELONG

G

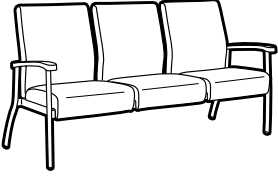
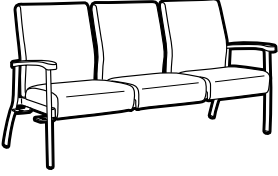
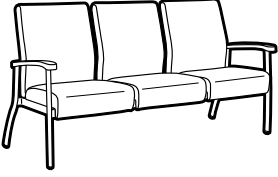
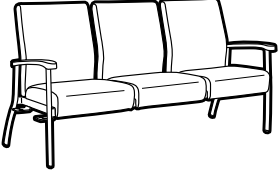
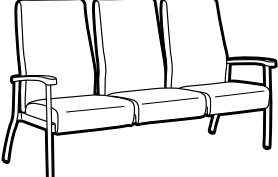
DESCRIPTION	MODEL#	STANDARD FABRIC GRADES											
		COM	2	3	4	5	6	7	8	9	10	11	12
 <p><b>Low Back Three Seat Chair</b> No Center Arm COM Yardage: 5 Freight Class: 250 Product Weight (lbs.): 132 Cubic Feet Per Carton: 65.25</p>	GC4233	\$3483	\$3642	\$3773	\$3964	\$4236	\$4341	\$4580	\$5029	\$5253	\$5671	\$6252	\$6971
		OVERALL DIMENSIONS			SEAT DIMENSIONS			BACK DIMENSIONS					
		W	D	H	W	D	H	W	H				
			72.75	26	37.5	70	18	18	70	19.5			
 <p><b>Low Back Three Seat Chair</b> No Center Arm, Right COM Yardage: 5 Freight Class: 250 Product Weight (lbs.): 134 Cubic Feet Per Carton: 65.25</p>	GC4233R	\$3524	\$3683	\$3815	\$4008	\$4278	\$4383	\$4621	\$5072	\$5296	\$5714	\$6295	\$7013
		OVERALL DIMENSIONS			SEAT DIMENSIONS			BACK DIMENSIONS					
		W	D	H	W	D	H	W	H				
			72.75	26	37.5	70	18	18	70	19.5			
 <p><b>Low Back Three Seat Chair</b> No Center Arm, Left COM Yardage: 5 Freight Class: 250 Product Weight (lbs.): 134 Cubic Feet Per Carton: 65.25</p>	GC4233L	\$3524	\$3683	\$3815	\$4008	\$4278	\$4383	\$4621	\$5072	\$5296	\$5714	\$6295	\$7013
		OVERALL DIMENSIONS			SEAT DIMENSIONS			BACK DIMENSIONS					
		W	D	H	W	D	H	W	H				
			72.75	26	37.5	70	18	18	70	19.5			
 <p><b>Low Back Three Seat Chair</b> No Center Arm, Left &amp; Right COM Yardage: 5 Freight Class: 250 Product Weight (lbs.): 134 Cubic Feet Per Carton: 65.25</p>	GC4233B	\$3568	\$3725	\$3857	\$4048	\$4321	\$4427	\$4664	\$5113	\$5341	\$5756	\$6337	\$7054
		OVERALL DIMENSIONS			SEAT DIMENSIONS			BACK DIMENSIONS					
		W	D	H	W	D	H	W	H				
			72.75	26	37.5	70	18	18	70	19.5			
 <p><b>High Back Three Seat Chair</b> No Center Arm COM Yardage: 5.75 Freight Class: 300 Product Weight (lbs.): 138 Cubic Feet Per Carton: 80.75</p>	GC4233HB	\$3691	\$3872	\$4023	\$4245	\$4559	\$4678	\$4951	\$5469	\$5729	\$6209	\$6878	\$7700
		OVERALL DIMENSIONS			SEAT DIMENSIONS			BACK DIMENSIONS					
		W	D	H	W	D	H	W	H				
			72.75	26	42.5	70	18	18	70	24.5			

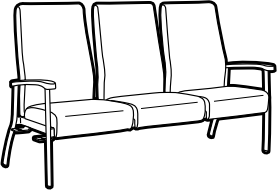
DESCRIPTION	MODEL#	STANDARD FABRIC GRADES											
		COM	2	3	4	5	6	7	8	9	10	11	12
 <p><b>High Back Three Seat Chair</b> No Center Arm, Right COM Yardage: 5.75 Freight Class: 300 Product Weight (lbs.): 140 Cubic Feet Per Carton: 80.75</p>	GC4233HBR	\$3732	\$3914	\$4062	\$4285	\$4600	\$4719	\$4991	\$5511	\$5769	\$6250	\$6917	\$7742
		<b>OVERALL DIMENSIONS</b>			<b>SEAT DIMENSIONS</b>			<b>BACK DIMENSIONS</b>					
		<b>W</b>	<b>D</b>	<b>H</b>	<b>W</b>	<b>D</b>	<b>H</b>	<b>W</b>	<b>H</b>				
Active weight 500 lbs./seat. Wood armcap option - <b>Add \$165</b>		72.75	26	42.5	70	18	18	70	24.5				

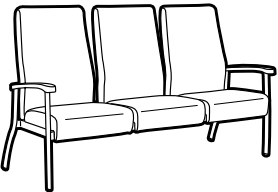
 <p><b>High Back Three Seat Chair</b> No Center Arm, Left COM Yardage: 5.75 Freight Class: 300 Product Weight (lbs.): 140 Cubic Feet Per Carton: 80.75</p>	GC4233HBL	\$3732	\$3914	\$4062	\$4285	\$4600	\$4719	\$4991	\$5511	\$5769	\$6250	\$6917	\$7742
		<b>OVERALL DIMENSIONS</b>			<b>SEAT DIMENSIONS</b>			<b>BACK DIMENSIONS</b>					
		<b>W</b>	<b>D</b>	<b>H</b>	<b>W</b>	<b>D</b>	<b>H</b>	<b>W</b>	<b>H</b>				
Active weight 500 lbs./seat. Wood armcap option - <b>Add \$165</b>		72.75	26	42.5	70	18	18	70	24.5				

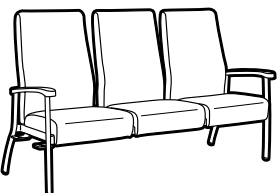
 <p><b>High Back Three Seat Chair</b> No Center Arm, Left &amp; Right COM Yardage: 5.75 Freight Class: 300 Product Weight (lbs.): 140 Cubic Feet Per Carton: 80.75</p>	GC4233HBB	\$3772	\$3954	\$4104	\$4325	\$4640	\$4758	\$5033	\$5551	\$5809	\$6290	\$6957	\$7783
		<b>OVERALL DIMENSIONS</b>			<b>SEAT DIMENSIONS</b>			<b>BACK DIMENSIONS</b>					
		<b>W</b>	<b>D</b>	<b>H</b>	<b>W</b>	<b>D</b>	<b>H</b>	<b>W</b>	<b>H</b>				
Active weight 500 lbs./seat. Wood armcap option - <b>Add \$165</b>		72.75	26	42.5	70	18	18	70	24.5				

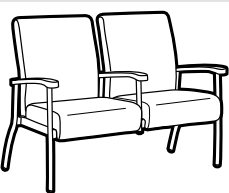
 <p><b>Low Back Two Seat Chair</b> Half Center Arm COM Yardage: 3.5 Freight Class: 250 Product Weight (lbs.): 100 Cubic Feet Per Carton: 43</p>	GC4234	\$2846	\$2958	\$3050	\$3184	\$3375	\$3448	\$3613	\$3929	\$4086	\$4380	\$4786	\$5287
		<b>OVERALL DIMENSIONS</b>			<b>SEAT DIMENSIONS</b>			<b>BACK DIMENSIONS</b>					
		<b>W</b>	<b>D</b>	<b>H</b>	<b>W</b>	<b>D</b>	<b>H</b>	<b>W</b>	<b>H</b>				
Active weight 500 lbs./seat. Wood armcap option - <b>Add \$244</b>		50.75	26	37.5	22	18	18	21.5	19.5				

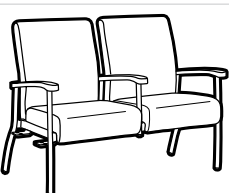
 <p><b>Low Back Two Seat Chair</b> Half Center Arm, Right COM Yardage: 3.5 Freight Class: 250 Product Weight (lbs.): 101 Cubic Feet Per Carton: 43</p>	GC4234R	\$2888	\$2997	\$3089	\$3223	\$3415	\$3489	\$3656	\$3971	\$4129	\$4421	\$4827	\$5327
		<b>OVERALL DIMENSIONS</b>			<b>SEAT DIMENSIONS</b>			<b>BACK DIMENSIONS</b>					
		<b>W</b>	<b>D</b>	<b>H</b>	<b>W</b>	<b>D</b>	<b>H</b>	<b>W</b>	<b>H</b>				
Active weight 500 lbs./seat. Wood armcap option - <b>Add \$244</b>		50.75	26	37.5	22	18	18	21.5	19.5				

# SEATING

# GC-BELONG

G

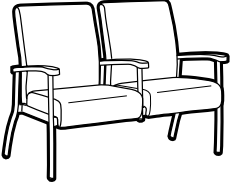
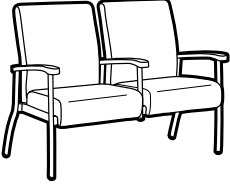
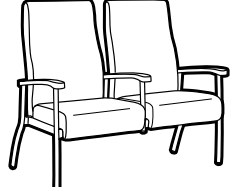
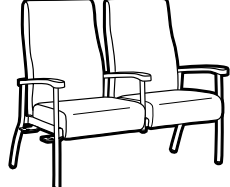
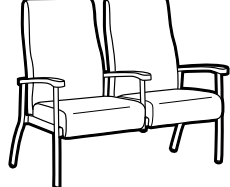
DESCRIPTION	MODEL#	STANDARD FABRIC GRADES											
		COM	2	3	4	5	6	7	8	9	10	11	12
 <p><b>Low Back Two Seat Chair</b> Half Center Arm, Left COM Yardage: 3.5 Freight Class: 250 Product Weight (lbs.): 101 Cubic Feet Per Carton: 43</p>	GC4234L	\$2888	\$2997	\$3089	\$3223	\$3415	\$3489	\$3656	\$3971	\$4129	\$4421	\$4827	\$5327
		<b>OVERALL DIMENSIONS</b>			<b>SEAT DIMENSIONS</b>			<b>BACK DIMENSIONS</b>					
		W	D	H	W	D	H	W	H				
			50.75	26	37.5	22	18	18	21.5	19.5			
 <p><b>Low Back Two Seat Chair</b> Half Center Arm, Left &amp; Right COM Yardage: 3.5 Freight Class: 250 Product Weight (lbs.): 102 Cubic Feet Per Carton: 43</p>	GC4234B	\$2929	\$3040	\$3132	\$3267	\$3457	\$3532	\$3699	\$4014	\$4170	\$4463	\$4869	\$5370
		<b>OVERALL DIMENSIONS</b>			<b>SEAT DIMENSIONS</b>			<b>BACK DIMENSIONS</b>					
		W	D	H	W	D	H	W	H				
			50.75	26	37.5	22	18	18	21.5	19.5			
 <p><b>High Back Two Seat Chair</b> Half Center Arm COM Yardage: 4 Freight Class: 300 Product Weight (lbs.): 104 Cubic Feet Per Carton: 56.5</p>	GC4234HB	\$3100	\$3227	\$3332	\$3485	\$3704	\$3787	\$3979	\$4337	\$4519	\$4852	\$5315	\$5888
		<b>OVERALL DIMENSIONS</b>			<b>SEAT DIMENSIONS</b>			<b>BACK DIMENSIONS</b>					
		W	D	H	W	D	H	W	H				
			50.75	26	42.5	22	18	18	21.5	24.5			
 <p><b>High Back Two Seat Chair</b> Half Center Arm, Right COM Yardage: 4 Freight Class: 300 Product Weight (lbs.): 104 Cubic Feet Per Carton: 56.5</p>	GC4234HBR	\$3144	\$3271	\$3376	\$3531	\$3748	\$3832	\$4023	\$4381	\$4564	\$4896	\$5360	\$5933
		<b>OVERALL DIMENSIONS</b>			<b>SEAT DIMENSIONS</b>			<b>BACK DIMENSIONS</b>					
		W	D	H	W	D	H	W	H				
			50.75	26	42.5	22	18	18	21.5	24.5			
 <p><b>High Back Two Seat Chair</b> Half Center Arm, Left COM Yardage: 4 Freight Class: 300 Product Weight (lbs.): 104 Cubic Feet Per Carton: 56.5</p>	GC4234HBL	\$3144	\$3271	\$3376	\$3531	\$3748	\$3832	\$4023	\$4381	\$4564	\$4896	\$5360	\$5933
		<b>OVERALL DIMENSIONS</b>			<b>SEAT DIMENSIONS</b>			<b>BACK DIMENSIONS</b>					
		W	D	H	W	D	H	W	H				
			50.75	26	42.5	22	18	18	21.5	24.5			

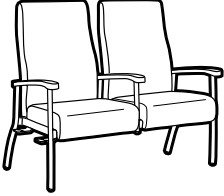
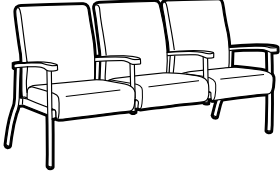
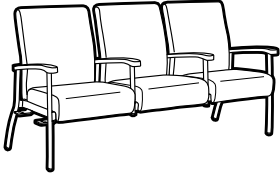
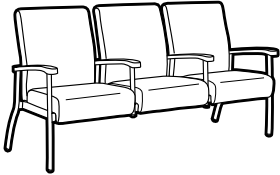
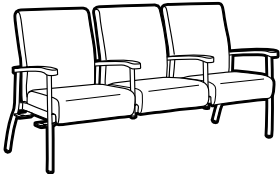
DESCRIPTION	MODEL#	STANDARD FABRIC GRADES											
		COM	2	3	4	5	6	7	8	9	10	11	12
 <p><b>High Back Two Seat Chair</b> Half Center Arm, Left &amp; Right COM Yardage: 4 Freight Class: 300 Product Weight (lbs.): 108 Cubic Feet Per Carton: 56.5</p>	GC4234HBB	\$3187	\$3314	\$3418	\$3574	\$3790	\$3874	\$4064	\$4422	\$4606	\$4939	\$5402	\$5975
		<b>OVERALL DIMENSIONS</b>			<b>SEAT DIMENSIONS</b>			<b>BACK DIMENSIONS</b>					
		W	D	H	W	D	H	W	H				
			50.75	26	42.5	22	18	18	21.5	24.5			
 <p><b>Low Back Three Seat Chair</b> Half Center Arms COM Yardage: 5 Freight Class: 250 Product Weight (lbs.): 142 Cubic Feet Per Carton: 65.25</p>	GC4235	\$4054	\$4211	\$4344	\$4534	\$4806	\$4911	\$5150	\$5600	\$5824	\$6242	\$6822	\$7541
		<b>OVERALL DIMENSIONS</b>			<b>SEAT DIMENSIONS</b>			<b>BACK DIMENSIONS</b>					
		W	D	H	W	D	H	W	H				
			74.5	26	37.5	22	18	18	21.5	19.5			
 <p><b>Low Back Three Seat Chair</b> Half Center Arms, Right COM Yardage: 5 Freight Class: 250 Product Weight (lbs.): 143 Cubic Feet Per Carton: 65.25</p>	GC4235R	\$4095	\$4254	\$4383	\$4576	\$4849	\$4953	\$5192	\$5642	\$5865	\$6285	\$6865	\$7583
		<b>OVERALL DIMENSIONS</b>			<b>SEAT DIMENSIONS</b>			<b>BACK DIMENSIONS</b>					
		W	D	H	W	D	H	W	H				
			74.5	26	37.5	22	18	18	21.5	19.5			
 <p><b>Low Back Three Seat Chair</b> Half Center Arms, Left COM Yardage: 5 Freight Class: 250 Product Weight (lbs.): 143 Cubic Feet Per Carton: 65.25</p>	GC4235L	\$4095	\$4254	\$4383	\$4576	\$4849	\$4953	\$5192	\$5642	\$5865	\$6285	\$6865	\$7583
		<b>OVERALL DIMENSIONS</b>			<b>SEAT DIMENSIONS</b>			<b>BACK DIMENSIONS</b>					
		W	D	H	W	D	H	W	H				
			74.5	26	37.5	22	18	18	21.5	19.5			
 <p><b>Low Back Three Seat Chair</b> Half Center Arms, Left &amp; Right COM Yardage: 5 Freight Class: 250 Product Weight (lbs.): 144 Cubic Feet Per Carton: 65.25</p>	GC4235B	\$4136	\$4293	\$4424	\$4616	\$4889	\$4993	\$5231	\$5680	\$5908	\$6323	\$6905	\$7622
		<b>OVERALL DIMENSIONS</b>			<b>SEAT DIMENSIONS</b>			<b>BACK DIMENSIONS</b>					
		W	D	H	W	D	H	W	H				
			74.5	26	37.5	22	18	18	21.5	19.5			

# SEATING

# GC-BELONG

G

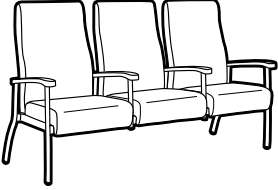
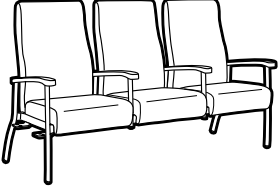
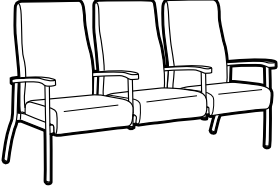
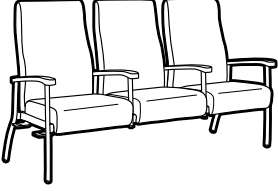
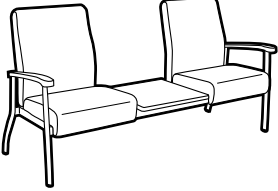
DESCRIPTION	MODEL#	STANDARD FABRIC GRADES											
		COM	2	3	4	5	6	7	8	9	10	11	12
 <p><b>High Back Three Seat Chair</b> Half Center Arms COM Yardage: 5.75 Freight Class: 300 Product Weight (lbs.): 148 Cubic Feet Per Carton: 80.75</p>	GC4235HB	\$4293	\$4473	\$4627	\$4847	\$5161	\$5281	\$5554	\$6072	\$6331	\$6811	\$7480	\$8302
		OVERALL DIMENSIONS			SEAT DIMENSIONS			BACK DIMENSIONS					
		W	D	H	W	D	H	W	H				
			74.5	26	42.5	22	18	18	21.5	24.5			
 <p><b>High Back Three Seat Chair</b> Half Center Arms, Right COM Yardage: 5.75 Freight Class: 300 Product Weight (lbs.): 159 Cubic Feet Per Carton: 80.75</p>	GC4235HBR	\$4334	\$4516	\$4664	\$4887	\$5201	\$5321	\$5593	\$6112	\$6371	\$6851	\$7519	\$8344
		OVERALL DIMENSIONS			SEAT DIMENSIONS			BACK DIMENSIONS					
		W	D	H	W	D	H	W	H				
			74.5	26	42.5	22	18	18	21.5	24.5			
 <p><b>High Back Three Seat Chair</b> Half Center Arms, Left COM Yardage: 5.75 Freight Class: 300 Product Weight (lbs.): 159 Cubic Feet Per Carton: 80.75</p>	GC4235HBL	\$4334	\$4516	\$4664	\$4887	\$5201	\$5321	\$5593	\$6112	\$6371	\$6851	\$7519	\$8344
		OVERALL DIMENSIONS			SEAT DIMENSIONS			BACK DIMENSIONS					
		W	D	H	W	D	H	W	H				
			74.5	26	42.5	22	18	18	21.5	24.5			
 <p><b>High Back Three Seat Chair</b> Half Center Arms, Left &amp; Right COM Yardage: 5.75 Freight Class: 300 Product Weight (lbs.): 160 Cubic Feet Per Carton: 80.75</p>	GC4235HBB	\$4376	\$4558	\$4709	\$4931	\$5243	\$5363	\$5637	\$6154	\$6413	\$6894	\$7561	\$8386
		OVERALL DIMENSIONS			SEAT DIMENSIONS			BACK DIMENSIONS					
		W	D	H	W	D	H	W	H				
			74.5	26	42.5	22	18	18	21.5	24.5			
 <p><b>Low Back Two Seat Chair with Table</b> Center Table Top, No Center Arms COM Yardage: 3.5 Freight Class: 300 Product Weight (lbs.): 106 Cubic Feet Per Carton: 65.25</p>	GC4236	\$3282	\$3393	\$3485	\$3620	\$3811	\$3884	\$4052	\$4366	\$4522	\$4815	\$5222	\$5723
		OVERALL DIMENSIONS			SEAT DIMENSIONS			BACK DIMENSIONS					
		W	D	H	W	D	H	W	H				
			72.75	26	37.5	44	18	18	44	19.5			

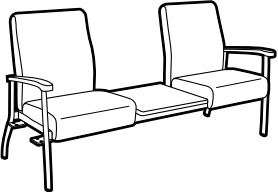

DESCRIPTION	MODEL#	STANDARD FABRIC GRADES											
		COM	2	3	4	5	6	7	8	9	10	11	12
 <p><b>Low Back Two Seat Chair with Table</b> Center Table Top, No Center Arms, Right                      COM Yardage: 3.5                      Freight Class: 300                      Product Weight (lbs.): 107                      Cubic Feet Per Carton: 65.25</p>	<b>GC4236R</b>	\$3323	\$3434	\$3526	\$3661	\$3852	\$3925	\$4093	\$4407	\$4564	\$4856	\$5264	\$5763
			<b>OVERALL DIMENSIONS</b> W D H			<b>SEAT DIMENSIONS</b> W D H			<b>BACK DIMENSIONS</b> W H				
		72.75	26	37.5	44	18	18	44	19.5				

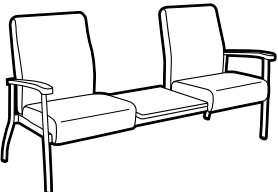
 <p><b>Low Back Two Seat Chair with Table</b> Center Table Top, No Center Arms, Left                      COM Yardage: 3.5                      Freight Class: 300                      Product Weight (lbs.): 107                      Cubic Feet Per Carton: 65.25</p>	<b>GC4236L</b>	\$3323	\$3434	\$3526	\$3661	\$3852	\$3925	\$4093	\$4407	\$4564	\$4856	\$5264	\$5763
			<b>OVERALL DIMENSIONS</b> W D H			<b>SEAT DIMENSIONS</b> W D H			<b>BACK DIMENSIONS</b> W H				
		72.75	26	37.5	44	18	18	44	19.5				

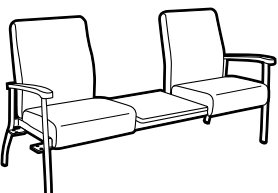
 <p><b>Low Back Two Seat Chair with Table</b> Center Table Top, No Center Arms, Left &amp; Right                      COM Yardage: 3.5                      Freight Class: 300                      Product Weight (lbs.): 108                      Cubic Feet Per Carton: 65.25</p>	<b>GC4236B</b>	\$3365	\$3476	\$3568	\$3702	\$3894	\$3968	\$4135	\$4450	\$4605	\$4899	\$5304	\$5806
			<b>OVERALL DIMENSIONS</b> W D H			<b>SEAT DIMENSIONS</b> W D H			<b>BACK DIMENSIONS</b> W H				
		72.75	26	37.5	44	18	18	44	19.5				

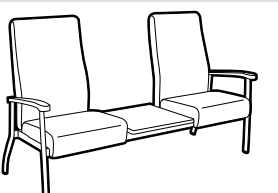
 <p><b>High Back Two Seat Chair with Table</b> Center Table Top, No Center Arms                      COM Yardage: 4                      Freight Class: 300                      Product Weight (lbs.): 110                      Cubic Feet Per Carton: 80.75</p>	<b>GC4236HB</b>	\$3514	\$3640	\$3746	\$3901	\$4117	\$4202	\$4392	\$4753	\$4934	\$5267	\$5729	\$6305
			<b>OVERALL DIMENSIONS</b> W D H			<b>SEAT DIMENSIONS</b> W D H			<b>BACK DIMENSIONS</b> W H				
		72.75	26	42.5	44	18	18	44	24.5				

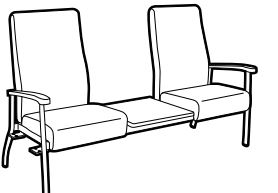
 <p><b>High Back Two Seat Chair with Table</b> Center Table Top, No Center Arms, Right                      COM Yardage: 4                      Freight Class: 300                      Product Weight (lbs.): 111                      Cubic Feet Per Carton: 80.75</p>	<b>GC4236HBR</b>	\$3553	\$3680	\$3784	\$3940	\$4157	\$4240	\$4431	\$4788	\$4972	\$5305	\$5768	\$6341
			<b>OVERALL DIMENSIONS</b> W D H			<b>SEAT DIMENSIONS</b> W D H			<b>BACK DIMENSIONS</b> W H				
		72.75	26	42.5	44	18	18	44	24.5				

# SEATING

# GC-BELONG

G

DESCRIPTION	MODEL#	STANDARD FABRIC GRADES											
		COM	2	3	4	5	6	7	8	9	10	11	12

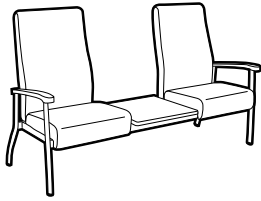

<b>GC4236HBL</b>	<b>\$3553</b>	<b>\$3680</b>	<b>\$3784</b>	<b>\$3940</b>	<b>\$4157</b>	<b>\$4240</b>	<b>\$4431</b>	<b>\$4788</b>	<b>\$4972</b>	<b>\$5305</b>	<b>\$5768</b>	<b>\$6341</b>
------------------	---------------	---------------	---------------	---------------	---------------	---------------	---------------	---------------	---------------	---------------	---------------	---------------

OVERALL DIMENSIONS			SEAT DIMENSIONS			BACK DIMENSIONS	
W	D	H	W	D	H	W	H

72.75	26	42.5	44	18	18	44	24.5
-------	----	------	----	----	----	----	------

**High Back Two Seat Chair with Table** Center Table Top, No Center Arms, Left  
 COM Yardage: 4  
 Freight Class: 300  
 Product Weight (lbs.): 111  
 Cubic Feet Per Carton: 80.75  
 Wood armcap option - **Add \$165**  
 Active weight 500 lbs./seat.  
 • Table top only offered in High Pressure Laminate

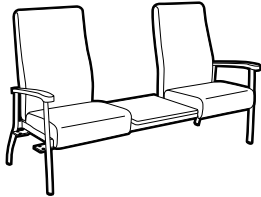

<b>GC4236HBB</b>	<b>\$3594</b>	<b>\$3721</b>	<b>\$3825</b>	<b>\$3981</b>	<b>\$4197</b>	<b>\$4280</b>	<b>\$4471</b>	<b>\$4831</b>	<b>\$5013</b>	<b>\$5346</b>	<b>\$5809</b>	<b>\$6382</b>
------------------	---------------	---------------	---------------	---------------	---------------	---------------	---------------	---------------	---------------	---------------	---------------	---------------

OVERALL DIMENSIONS			SEAT DIMENSIONS			BACK DIMENSIONS	
W	D	H	W	D	H	W	H

72.75	26	42.5	44	18	18	44	24.5
-------	----	------	----	----	----	----	------

**High Back Two Seat Chair with Table** Center Table Top, No Center Arms, Left & Right  
 COM Yardage: 4  
 Freight Class: 300  
 Product Weight (lbs.): 114  
 Cubic Feet Per Carton: 80.75  
 Wood armcap option - **Add \$165**  
 Active weight 500 lbs./seat.  
 • Table top only offered in High Pressure Laminate

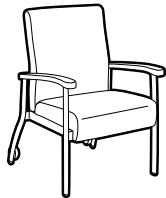

<b>GC4240</b>	<b>\$1817</b>	<b>\$1870</b>	<b>\$1918</b>	<b>\$1985</b>	<b>\$2081</b>	<b>\$2117</b>	<b>\$2201</b>	<b>\$2360</b>	<b>\$2437</b>	<b>\$2584</b>	<b>\$2786</b>	<b>\$3038</b>
---------------	---------------	---------------	---------------	---------------	---------------	---------------	---------------	---------------	---------------	---------------	---------------	---------------

OVERALL DIMENSIONS			SEAT DIMENSIONS			BACK DIMENSIONS	
W	D	H	W	D	H	W	H

26.75	27.5	37.5	22	18	18	21.5	19.5
-------	------	------	----	----	----	------	------

**Low Back Armchair** Casters  
 Active weight 500 lbs.  
 COM Yardage: 1.75  
 Freight Class: 250  
 Product Weight (lbs.): 49  
 Cubic Feet Per Carton: 20.25  
 Wood armcap option - **Add \$165**

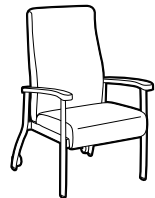

<b>GC4240HB</b>	<b>\$1885</b>	<b>\$1947</b>	<b>\$1998</b>	<b>\$2076</b>	<b>\$2185</b>	<b>\$2227</b>	<b>\$2322</b>	<b>\$2502</b>	<b>\$2592</b>	<b>\$2759</b>	<b>\$2992</b>	<b>\$3278</b>
-----------------	---------------	---------------	---------------	---------------	---------------	---------------	---------------	---------------	---------------	---------------	---------------	---------------

OVERALL DIMENSIONS			SEAT DIMENSIONS			BACK DIMENSIONS	
W	D	H	W	D	H	W	H

26.75	27.5	42.5	22	18	18	21.5	24.5
-------	------	------	----	----	----	------	------

**High Back Armchair** Casters  
 Active weight 500 lbs.  
 COM Yardage: 2  
 Freight Class: 250  
 Product Weight (lbs.): 54  
 Cubic Feet Per Carton: 22.25  
 Wood armcap option - **Add \$165**

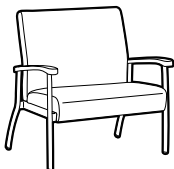

<b>GC4241</b>	<b>\$2100</b>	<b>\$2194</b>	<b>\$2273</b>	<b>\$2387</b>	<b>\$2552</b>	<b>\$2614</b>	<b>\$2758</b>	<b>\$3028</b>	<b>\$3161</b>	<b>\$3413</b>	<b>\$3760</b>	<b>\$4192</b>
---------------	---------------	---------------	---------------	---------------	---------------	---------------	---------------	---------------	---------------	---------------	---------------	---------------

OVERALL DIMENSIONS			SEAT DIMENSIONS			BACK DIMENSIONS	
W	D	H	W	D	H	W	H

37.5	28	37.5	32.5	18	18	32.5	19.5
------	----	------	------	----	----	------	------

**Bariatric Low Back Armchair**  
 Active weight 750 lbs.  
 COM Yardage: 3  
 Freight Class: 250  
 Product Weight (lbs.): 70  
 Cubic Feet Per Carton: 30.5  
 Wood armcap option - **Add \$165**  
 Armless Bariatric models are not available.

DESCRIPTION	MODEL#	STANDARD FABRIC GRADES											
		COM	2	3	4	5	6	7	8	9	10	11	12

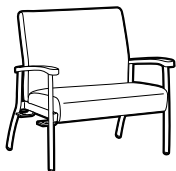

<b>GC4241R</b>	<b>\$2139</b>	<b>\$2234</b>	<b>\$2314</b>	<b>\$2427</b>	<b>\$2592</b>	<b>\$2654</b>	<b>\$2798</b>	<b>\$3068</b>	<b>\$3203</b>	<b>\$3453</b>	<b>\$3802</b>	<b>\$4232</b>
----------------	---------------	---------------	---------------	---------------	---------------	---------------	---------------	---------------	---------------	---------------	---------------	---------------

OVERALL DIMENSIONS			SEAT DIMENSIONS			BACK DIMENSIONS	
W	D	H	W	D	H	W	H

**Bariatric Low Back Armchair Right**  
 COM Yardage: 3  
 Freight Class: 250  
 Product Weight (lbs.): 71  
 Cubic Feet Per Carton: 30.5

Active weight 750 lbs.  
 Wood armcap option - **Add \$165**

*Armless Bariatric models are not available.*

37.5	28	37.5	32.5	18	18	32.5	19.5
------	----	------	------	----	----	------	------

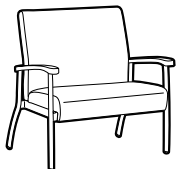

<b>GC4241L</b>	<b>\$2139</b>	<b>\$2234</b>	<b>\$2314</b>	<b>\$2427</b>	<b>\$2592</b>	<b>\$2654</b>	<b>\$2798</b>	<b>\$3068</b>	<b>\$3203</b>	<b>\$3453</b>	<b>\$3802</b>	<b>\$4232</b>
----------------	---------------	---------------	---------------	---------------	---------------	---------------	---------------	---------------	---------------	---------------	---------------	---------------

OVERALL DIMENSIONS			SEAT DIMENSIONS			BACK DIMENSIONS	
W	D	H	W	D	H	W	H

**Bariatric Low Back Armchair Left**  
 COM Yardage: 3  
 Freight Class: 250  
 Product Weight (lbs.): 71  
 Cubic Feet Per Carton: 30.5

Active weight 750 lbs.  
 Wood armcap option - **Add \$165**

*Armless Bariatric models are not available.*

37.5	28	37.5	32.5	18	18	32.5	19.5
------	----	------	------	----	----	------	------

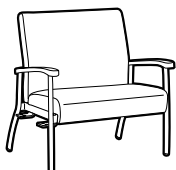

<b>GC4241B</b>	<b>\$2179</b>	<b>\$2274</b>	<b>\$2355</b>	<b>\$2471</b>	<b>\$2634</b>	<b>\$2695</b>	<b>\$2839</b>	<b>\$3110</b>	<b>\$3244</b>	<b>\$3496</b>	<b>\$3844</b>	<b>\$4272</b>
----------------	---------------	---------------	---------------	---------------	---------------	---------------	---------------	---------------	---------------	---------------	---------------	---------------

OVERALL DIMENSIONS			SEAT DIMENSIONS			BACK DIMENSIONS	
W	D	H	W	D	H	W	H

**Bariatric Low Back Armchair Left & Right**  
 COM Yardage: 3  
 Freight Class: 250  
 Product Weight (lbs.): 71  
 Cubic Feet Per Carton: 30.5

Active weight 750 lbs.  
 Wood armcap option - **Add \$165**

*Armless Bariatric models are not available.*

37.5	28	37.5	32.5	18	18	32.5	19.5
------	----	------	------	----	----	------	------

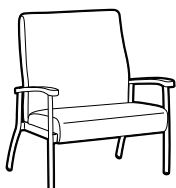

<b>GC4241HB</b>	<b>\$2386</b>	<b>\$2487</b>	<b>\$2574</b>	<b>\$2697</b>	<b>\$2877</b>	<b>\$2944</b>	<b>\$3100</b>	<b>\$3390</b>	<b>\$3537</b>	<b>\$3809</b>	<b>\$4186</b>	<b>\$4654</b>
-----------------	---------------	---------------	---------------	---------------	---------------	---------------	---------------	---------------	---------------	---------------	---------------	---------------

OVERALL DIMENSIONS			SEAT DIMENSIONS			BACK DIMENSIONS	
W	D	H	W	D	H	W	H

**Bariatric High Back Armchair**  
 COM Yardage: 3.25  
 Freight Class: 250  
 Product Weight (lbs.): 73  
 Cubic Feet Per Carton: 30.5

Active weight 750 lbs.  
 Wood armcap option - **Add \$165**

*Armless Bariatric models are not available.*

37.5	28	43	32.5	18	18	32.5	24.5
------	----	----	------	----	----	------	------

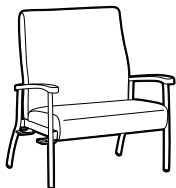

<b>GC4241HBR</b>	<b>\$2428</b>	<b>\$2530</b>	<b>\$2617</b>	<b>\$2741</b>	<b>\$2920</b>	<b>\$2987</b>	<b>\$3143</b>	<b>\$3431</b>	<b>\$3580</b>	<b>\$3853</b>	<b>\$4229</b>	<b>\$4693</b>
------------------	---------------	---------------	---------------	---------------	---------------	---------------	---------------	---------------	---------------	---------------	---------------	---------------

OVERALL DIMENSIONS			SEAT DIMENSIONS			BACK DIMENSIONS	
W	D	H	W	D	H	W	H

**Bariatric High Back Armchair Right**  
 COM Yardage: 3.25  
 Freight Class: 250  
 Product Weight (lbs.): 74  
 Cubic Feet Per Carton: 30.5

Active weight 750 lbs.  
 Wood armcap option - **Add \$165**

*Armless Bariatric models are not available.*

37.5	28	43	32.5	18	18	32.5	24.5
------	----	----	------	----	----	------	------

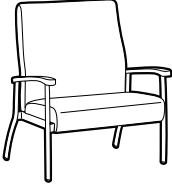
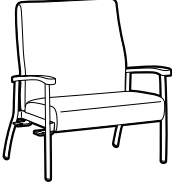
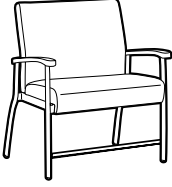
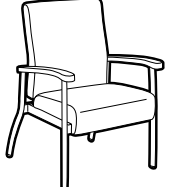
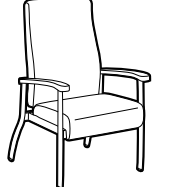
DESCRIPTION	MODEL#	STANDARD FABRIC GRADES											
		COM	2	3	4	5	6	7	8	9	10	11	12
 <p><b>Bariatric High Back Armchair Left</b> COM Yardage: 3.25 Freight Class: 250 Product Weight (lbs.): 74 Cubic Feet Per Carton: 30.5</p>	<b>GC4241HBL</b>	\$2428	\$2530	\$2617	\$2741	\$2920	\$2987	\$3143	\$3431	\$3580	\$3853	\$4229	\$4693
		<b>OVERALL DIMENSIONS</b>			<b>SEAT DIMENSIONS</b>			<b>BACK DIMENSIONS</b>					
		W	D	H	W	D	H	W	H				
		37.5	28	43	32.5	18	18	32.5	24.5				
		Active weight 750 lbs. Wood armcap option - <b>Add \$165</b> <i>Armless Bariatric models are <u>not</u> available.</i>											
 <p><b>Bariatric High Back Armchair Left &amp; Right</b> COM Yardage: 3.25 Freight Class: 250 Product Weight (lbs.): 74 Cubic Feet Per Carton: 30.50</p>	<b>GC4241HBB</b>	\$2471	\$2573	\$2659	\$2784	\$2964	\$3031	\$3186	\$3476	\$3623	\$3895	\$4274	\$4736
		<b>OVERALL DIMENSIONS</b>			<b>SEAT DIMENSIONS</b>			<b>BACK DIMENSIONS</b>					
		W	D	H	W	D	H	W	H				
		37.5	28	43	32.5	18	18	32.5	24.5				
		Active weight 750 lbs. Wood armcap option - <b>Add \$165</b> <i>Armless Bariatric models are <u>not</u> available.</i>											
 <p><b>Bariatric Low Back Armchair Post Surgery.</b> Designed to immobilize the pelvis and hip joints after surgery. COM Yardage: 3 Freight Class: 250 Product Weight (lbs.): 76 Cubic Feet Per Carton: 33.5</p>	<b>GC4241-24</b> 24" Seat Height	\$2449	\$2545	\$2622	\$2738	\$2903	\$2964	\$3107	\$3379	\$3512	\$3764	\$4113	\$4541
		<b>OVERALL DIMENSIONS</b>			<b>SEAT DIMENSIONS</b>			<b>BACK DIMENSIONS</b>					
		W	D	H	W	D	H	W	H				
		37.5	28.75	43.5	32.5	18	24	32.5	19.5				
		Wood armcap option - <b>Add \$165</b> Active weight 750 lbs. <i>Armless Bariatric models are <u>not</u> available.</i>											
 <p><b>Low Back Armchair Flex Back</b> COM Yardage: 1.75 Freight Class: 250 Product Weight (lbs.): 53 Cubic Feet Per Carton: 20.25</p>	<b>GC4242</b>	\$2166	\$2222	\$2268	\$2336	\$2430	\$2468	\$2550	\$2709	\$2789	\$2934	\$3138	\$3388
		<b>OVERALL DIMENSIONS</b>			<b>SEAT DIMENSIONS</b>			<b>BACK DIMENSIONS</b>					
		W	D	H	W	D	H	W	H				
		26.5	28	37.5	22	18	18	21.5	19.5				
		Active weight 500 lbs. Wood armcap option - <b>Add \$165</b>											
 <p><b>High Back Armchair Flex Back</b> COM Yardage: 2 Freight Class: 250 Product Weight (lbs.): 61 Cubic Feet Per Carton: 22.25</p>	<b>GC4242HB</b>	\$2236	\$2296	\$2352	\$2429	\$2539	\$2580	\$2677	\$2856	\$2944	\$3113	\$3344	\$3630
		<b>OVERALL DIMENSIONS</b>			<b>SEAT DIMENSIONS</b>			<b>BACK DIMENSIONS</b>					
		W	D	H	W	D	H	W	H				
		26.5	28	43	22	18	18	21.5	24.5				
		Active weight 500 lbs. Wood armcap option - <b>Add \$165</b>											

DESCRIPTION	MODEL#	STANDARD FABRIC GRADES											
		COM	2	3	4	5	6	7	8	9	10	11	12

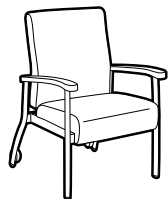

GC4243

COM	2	3	4	5	6	7	8	9	10	11	12
\$2296	\$2350	\$2396	\$2465	\$2561	\$2596	\$2681	\$2840	\$2919	\$3065	\$3266	\$3516

OVERALL DIMENSIONS			SEAT DIMENSIONS			BACK DIMENSIONS	
W	D	H	W	D	H	W	H

26.75	27.5	37.5	22	18	18	21.5	19.5
-------	------	------	----	----	----	------	------

**Low Back Armchair** Flex Back, Casters  
 COM Yardage: 1.75  
 Freight Class: 250  
 Product Weight (lbs.): 49  
 Cubic Feet Per Carton: 20.25

Active weight 500 lbs.  
 Wood armcap option - **Add \$165**

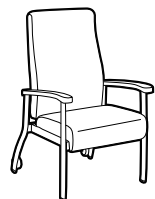

GC4243HB

COM	2	3	4	5	6	7	8	9	10	11	12
\$2367	\$2428	\$2481	\$2559	\$2668	\$2710	\$2805	\$2985	\$3075	\$3243	\$3474	\$3761

OVERALL DIMENSIONS			SEAT DIMENSIONS			BACK DIMENSIONS	
W	D	H	W	D	H	W	H

26.75	27.5	42.5	22	18	18	21.5	24.5
-------	------	------	----	----	----	------	------

**High Back Armchair** Flex Back, Casters  
 COM Yardage: 2  
 Freight Class: 250  
 Product Weight (lbs.): 51  
 Cubic Feet Per Carton: 22.25

Active weight 500 lbs.  
 Wood armcap option - **Add \$165**

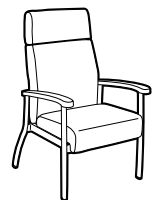

GC4244HB

COM	2	3	4	5	6	7	8	9	10	11	12
\$2105	\$2176	\$2236	\$2321	\$2446	\$2491	\$2598	\$2800	\$2902	\$3091	\$3351	\$3675

OVERALL DIMENSIONS			SEAT DIMENSIONS			BACK DIMENSIONS	
W	D	H	W	D	H	W	H

26.75	26	42.5	22	18	18	21.5	24.5
-------	----	------	----	----	----	------	------

**High Back Armchair** Split Back  
 COM Yardage: 2.25  
 Freight Class: 250  
 Product Weight (lbs.): 54  
 Cubic Feet Per Carton: 20.25

Active weight 500 lbs.  
 Wood armcap option - **Add \$165**



GC4245HB

COM	2	3	4	5	6	7	8	9	10	11	12
\$2236	\$2305	\$2366	\$2452	\$2576	\$2621	\$2728	\$2931	\$3032	\$3222	\$3482	\$3804

OVERALL DIMENSIONS			SEAT DIMENSIONS			BACK DIMENSIONS	
W	D	H	W	D	H	W	H

26.75	26	42.5	22	18	18	21.5	24.5
-------	----	------	----	----	----	------	------

**High Back Armchair** Split Back, Casters  
 COM Yardage: 2.25  
 Freight Class: 250  
 Product Weight (lbs.): 54  
 Cubic Feet Per Carton: 20.25

Active weight 500 lbs.  
 Wood armcap option - **Add \$165**



GC4251

COM	2	3	4	5	6	7	8	9	10	11	12
\$1067	\$1113	\$1153	\$1211	\$1294	\$1323	\$1395	\$1531	\$1598	\$1724	\$1898	\$2112

OVERALL DIMENSIONS			SEAT DIMENSIONS			BACK DIMENSIONS	
W	D	H	W	D	H	W	H

24.75	26.5	18					
-------	------	----	--	--	--	--	--



**Single Seat Bench**  
 COM Yardage: 1.5  
 Freight Class: 250  
 Product Weight (lbs.): 30  
 Cubic Feet Per Carton: 13

Active weight 500 lbs.

# SEATING

# GC-BELONG

G

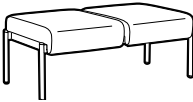
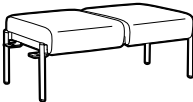
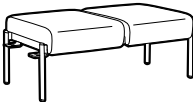
DESCRIPTION	MODEL#	STANDARD FABRIC GRADES											
		COM	2	3	4	5	6	7	8	9	10	11	12
 <p><b>Single Seat Bench Left</b> COM Yardage: 1.5 Freight Class: 250 Product Weight (lbs.): 31 Cubic Feet Per Carton: 13</p>	GC4251L	\$1108	\$1155	\$1195	\$1253	\$1336	\$1366	\$1439	\$1573	\$1640	\$1766	\$1941	\$2154
		OVERALL DIMENSIONS			SEAT DIMENSIONS			BACK DIMENSIONS					
		W	D	H	W	D	H	W	H				
		Active weight 500 lbs.	25.75	26.5	18								
 <p><b>Single Seat Bench Left &amp; Right</b> COM Yardage: 1.5 Freight Class: 250 Product Weight (lbs.): 32 Cubic Feet Per Carton: 13</p>	GC4251B	\$1154	\$1198	\$1239	\$1297	\$1380	\$1412	\$1482	\$1617	\$1683	\$1810	\$1985	\$2199
		OVERALL DIMENSIONS			SEAT DIMENSIONS			BACK DIMENSIONS					
		W	D	H	W	D	H	W	H				
		Active weight 500 lbs.	26.75	26.5	18								
 <p><b>Two Seat Bench</b> COM Yardage: 2.25 Freight Class: 250 Product Weight (lbs.): 53 Cubic Feet Per Carton: 23</p>	GC4252	\$1940	\$2011	\$2071	\$2157	\$2281	\$2326	\$2434	\$2635	\$2738	\$2926	\$3187	\$3511
		OVERALL DIMENSIONS			SEAT DIMENSIONS			BACK DIMENSIONS					
		W	D	H	W	D	H	W	H				
		Active weight 500 lbs./seat.	47.75	26.5	18								
 <p><b>Two Seat Bench Left</b> COM Yardage: 2.25 Freight Class: 250 Product Weight (lbs.): 54 Cubic Feet Per Carton: 23</p>	GC4252L	\$1984	\$2053	\$2114	\$2198	\$2323	\$2369	\$2475	\$2677	\$2781	\$2969	\$3229	\$3553
		OVERALL DIMENSIONS			SEAT DIMENSIONS			BACK DIMENSIONS					
		W	D	H	W	D	H	W	H				
		Active weight 500 lbs./seat.	48.75	26.5	18								
 <p><b>Two Seat Bench Left &amp; Right</b> COM Yardage: 2.25 Freight Class: 250 Product Weight (lbs.): 55 Cubic Feet Per Carton: 23</p>	GC4252B	\$2028	\$2097	\$2157	\$2243	\$2368	\$2413	\$2519	\$2722	\$2825	\$3013	\$3273	\$3595
		OVERALL DIMENSIONS			SEAT DIMENSIONS			BACK DIMENSIONS					
		W	D	H	W	D	H	W	H				
		Active weight 500 lbs./seat.	49.75	26.5	18								

DESCRIPTION	MODEL#	STANDARD FABRIC GRADES											
		COM	2	3	4	5	6	7	8	9	10	11	12

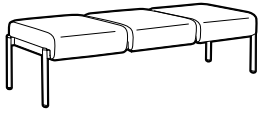

**Three Seat Bench**  
 COM Yardage: 3  
 Freight Class: 250  
 Product Weight (lbs.): 73  
 Cubic Feet Per Carton: 33.25

Active weight 500 lbs./seat.

OVERALL DIMENSIONS			SEAT DIMENSIONS			BACK DIMENSIONS	
W	D	H	W	D	H	W	H
70.75	26.5	18					

COM	2	3	4	5	6	7	8	9	10	11	12	
<b>GC4253</b>	<b>\$2842</b>	<b>\$2936</b>	<b>\$3016</b>	<b>\$3132</b>	<b>\$3298</b>	<b>\$3356</b>	<b>\$3500</b>	<b>\$3771</b>	<b>\$3906</b>	<b>\$4158</b>	<b>\$4505</b>	<b>\$4935</b>

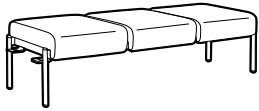

**Three Seat Bench Left**  
 COM Yardage: 3  
 Freight Class: 250  
 Product Weight (lbs.): 74  
 Cubic Feet Per Carton: 33.25

Active weight 500 lbs./seat.

OVERALL DIMENSIONS			SEAT DIMENSIONS			BACK DIMENSIONS	
W	D	H	W	D	H	W	H
71.75	26.5	18					

COM	2	3	4	5	6	7	8	9	10	11	12	
<b>GC4253L</b>	<b>\$2887</b>	<b>\$2981</b>	<b>\$3060</b>	<b>\$3177</b>	<b>\$3340</b>	<b>\$3401</b>	<b>\$3543</b>	<b>\$3816</b>	<b>\$3950</b>	<b>\$4202</b>	<b>\$4550</b>	<b>\$4979</b>

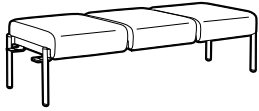

**Three Seat Bench Left & Right**  
 COM Yardage: 3  
 Freight Class: 250  
 Product Weight (lbs.): 75  
 Cubic Feet Per Carton: 33.25

Active weight 500 lbs./seat.

OVERALL DIMENSIONS			SEAT DIMENSIONS			BACK DIMENSIONS	
W	D	H	W	D	H	W	H
72.75	26.5	18					

COM	2	3	4	5	6	7	8	9	10	11	12	
<b>GC4253B</b>	<b>\$2930</b>	<b>\$3024</b>	<b>\$3103</b>	<b>\$3220</b>	<b>\$3383</b>	<b>\$3444</b>	<b>\$3588</b>	<b>\$3859</b>	<b>\$3993</b>	<b>\$4245</b>	<b>\$4593</b>	<b>\$5024</b>

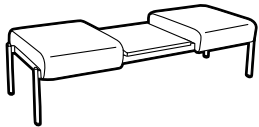

**Two Seat Bench with Table Center Table Top**  
 COM Yardage: 2.25  
 Freight Class: 250  
 Product Weight (lbs.): 68  
 Cubic Feet Per Carton: 33.25

Active weight 500 lbs./seat.

- Table top only offered in High Pressure Laminate

OVERALL DIMENSIONS			SEAT DIMENSIONS			BACK DIMENSIONS	
W	D	H	W	D	H	W	H
70.75	26.5	18					

COM	2	3	4	5	6	7	8	9	10	11	12	
<b>GC4256</b>	<b>\$2769</b>	<b>\$2837</b>	<b>\$2898</b>	<b>\$2984</b>	<b>\$3108</b>	<b>\$3152</b>	<b>\$3260</b>	<b>\$3463</b>	<b>\$3564</b>	<b>\$3753</b>	<b>\$4013</b>	<b>\$4336</b>

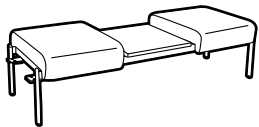

**Two Seat Bench with Table Center Table Top, Left**  
 COM Yardage: 2.25  
 Freight Class: 250  
 Product Weight (lbs.): 72  
 Cubic Feet Per Carton: 33.25

Active weight 500 lbs./seat.

- Table top only offered in High Pressure Laminate

OVERALL DIMENSIONS			SEAT DIMENSIONS			BACK DIMENSIONS	
W	D	H	W	D	H	W	H
71.75	26.5	18					

DESCRIPTION	MODEL#	STANDARD FABRIC GRADES											
		COM	2	3	4	5	6	7	8	9	10	11	12

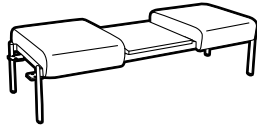

**Two Seat Bench with Table** Center Table Top, Left & Right  
 COM Yardage: 2.25  
 Freight Class: 250  
 Product Weight (lbs.): 70  
 Cubic Feet Per Carton: 33.25

Active weight 500 lbs./seat.

• Table top only offered in High Pressure Laminate

	COM	2	3	4	5	6	7	8	9	10	11	12
<b>GC4256B</b>	<b>\$2854</b>	<b>\$2923</b>	<b>\$2984</b>	<b>\$3071</b>	<b>\$3193</b>	<b>\$3239</b>	<b>\$3346</b>	<b>\$3550</b>	<b>\$3651</b>	<b>\$3839</b>	<b>\$4100</b>	<b>\$4423</b>

OVERALL DIMENSIONS			SEAT DIMENSIONS			BACK DIMENSIONS	
W	D	H	W	D	H	W	H

72.75 26.5 18

DESCRIPTION	MODEL#	STANDARD FABRIC GRADES											
		COM	2	3	4	5	6	7	8	9	10	11	12

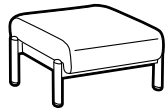

**Ottoman** Angled cushion top.  
 COM Yardage: 1  
 Freight Class: 150  
 Product Weight (lbs.): 16  
 Cubic Feet Per Carton: 3.6

Active weight 500 lbs./seat.

	COM	2	3	4	5	6	7	8	9	10	11	12
<b>GC4259</b>	<b>\$794</b>	<b>\$825</b>	<b>\$851</b>	<b>\$891</b>	<b>\$944</b>	<b>\$966</b>	<b>\$1014</b>	<b>\$1105</b>	<b>\$1148</b>	<b>\$1234</b>	<b>\$1348</b>	<b>\$1492</b>

OVERALL DIMENSIONS			SEAT DIMENSIONS			BACK DIMENSIONS	
W	D	H	W	D	H	W	H

17.75 19 10.5

DESCRIPTION	MODEL#	STANDARD FABRIC GRADES											
		COM	2	3	4	5	6	7	8	9	10	11	12

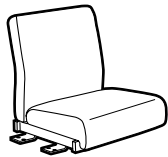

**Low Back Single Seat Armless Bridge** Left & Right  
 COM Yardage: 1.75  
 Freight Class: 250  
 Product Weight (lbs.): 36  
 Cubic Feet Per Carton: 13

Active weight 500 lbs.

**Not freestanding.**  
 Suspends between 2 units via linking brackets.

	COM	2	3	4	5	6	7	8	9	10	11	12
<b>GC4261</b>	<b>\$1112</b>	<b>\$1165</b>	<b>\$1213</b>	<b>\$1281</b>	<b>\$1375</b>	<b>\$1412</b>	<b>\$1496</b>	<b>\$1653</b>	<b>\$1732</b>	<b>\$1879</b>	<b>\$2081</b>	<b>\$2333</b>

OVERALL DIMENSIONS			SEAT DIMENSIONS			BACK DIMENSIONS	
W	D	H	W	D	H	W	H

26.75 24 25.5 22 18 -- 21.5 19.5

DESCRIPTION	MODEL#	STANDARD FABRIC GRADES											
		COM	2	3	4	5	6	7	8	9	10	11	12



**High Back Single Seat Armless Bridge** Left & Right  
 COM Yardage: 2  
 Freight Class: 250  
 Product Weight (lbs.): 41  
 Cubic Feet Per Carton: 14.5

Active weight 500 lbs.

**Not freestanding.**  
 Suspends between 2 units via linking brackets.

	COM	2	3	4	5	6	7	8	9	10	11	12
<b>GC4261HB</b>	<b>\$1173</b>	<b>\$1235</b>	<b>\$1288</b>	<b>\$1367</b>	<b>\$1474</b>	<b>\$1516</b>	<b>\$1611</b>	<b>\$1793</b>	<b>\$1883</b>	<b>\$2050</b>	<b>\$2282</b>	<b>\$2568</b>

OVERALL DIMENSIONS			SEAT DIMENSIONS			BACK DIMENSIONS	
W	D	H	W	D	H	W	H

26.75 24 30.5 22 18 -- 21.5 24.5

DESCRIPTION	MODEL#	STANDARD FABRIC GRADES											
		COM	2	3	4	5	6	7	8	9	10	11	12

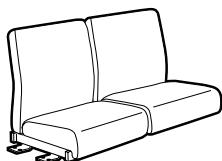

**Low Back Two Seat Armless Bridge** Left & Right  
 COM Yardage: 3.5  
 Freight Class: 250  
 Product Weight (lbs.): 66  
 Cubic Feet Per Carton: 23

Active weight 500 lbs./seat.

**Not freestanding.**  
 Suspends between 2 units via linking brackets.

	COM	2	3	4	5	6	7	8	9	10	11	12
<b>GC4262</b>	<b>\$2125</b>	<b>\$2236</b>	<b>\$2328</b>	<b>\$2462</b>	<b>\$2654</b>	<b>\$2727</b>	<b>\$2894</b>	<b>\$3209</b>	<b>\$3366</b>	<b>\$3659</b>	<b>\$4065</b>	<b>\$4565</b>

OVERALL DIMENSIONS			SEAT DIMENSIONS			BACK DIMENSIONS	
W	D	H	W	D	H	W	H

49.75 24 25.5 44 18 -- 44 19.5



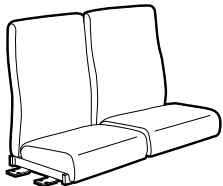

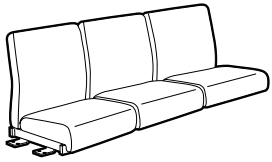
DESCRIPTION	MODEL#	STANDARD FABRIC GRADES											
		COM	2	3	4	5	6	7	8	9	10	11	12
 <p><b>High Back Two Seat Armless Bridge</b> Left &amp; Right COM Yardage: 4 Freight Class: 250 Product Weight (lbs.): 72 Cubic Feet Per Carton: 24</p>	<b>GC4262HB</b>	\$2253	\$2380	\$2484	\$2640	\$2856	\$2940	\$3130	\$3490	\$3672	\$4007	\$4468	\$5042
		<b>OVERALL DIMENSIONS</b> W D H			<b>SEAT DIMENSIONS</b> W D H			<b>BACK DIMENSIONS</b> W H					
		49.75	24	30.5	44	18	--	44	24.5				

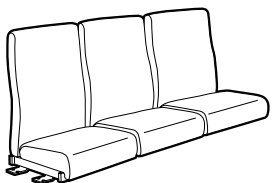
 <p><b>Low Back Three Seat Armless Bridge</b> Left &amp; Right COM Yardage: 5 Freight Class: 300 Product Weight (lbs.): 74 Cubic Feet Per Carton: 38.75</p>	<b>GC4263</b>	\$3094	\$3251	\$3383	\$3576	\$3847	\$3953	\$4190	\$4640	\$4864	\$5282	\$5863	\$6580
		<b>OVERALL DIMENSIONS</b> W D H			<b>SEAT DIMENSIONS</b> W D H			<b>BACK DIMENSIONS</b> W H					
		72.75	24	25.5	70	18	--	70	19.5				

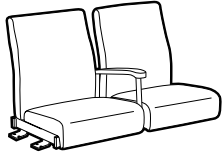
 <p><b>High Back Three Seat Armless Bridge</b> Left &amp; Right COM Yardage: 5.75 Freight Class: 250 Product Weight (lbs.): 80 Cubic Feet Per Carton: 38.75</p>	<b>GC4263HB</b>	\$3301	\$3483	\$3633	\$3854	\$4169	\$4288	\$4560	\$5079	\$5338	\$5820	\$6486	\$7311
		<b>OVERALL DIMENSIONS</b> W D H			<b>SEAT DIMENSIONS</b> W D H			<b>BACK DIMENSIONS</b> W H					
		72.75	24	30.5	70	18	--	70	24.5				

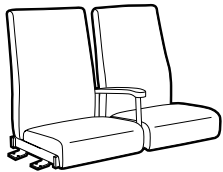
 <p><b>Low Back Two Seat Bridge</b> Half Center Arm, Left &amp; Right COM Yardage: 3.5 Freight Class: 250 Product Weight (lbs.): 58 Cubic Feet Per Carton: 27.25</p>	<b>GC4264</b>	\$2557	\$2666	\$2758	\$2892	\$3084	\$3158	\$3325	\$3640	\$3796	\$4089	\$4494	\$4995
		<b>OVERALL DIMENSIONS</b> W D H			<b>SEAT DIMENSIONS</b> W D H			<b>BACK DIMENSIONS</b> W H					
		50.75	24	25.5	22	18	--	21.5	19.5				

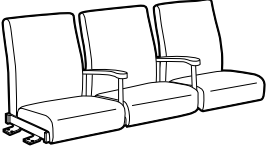
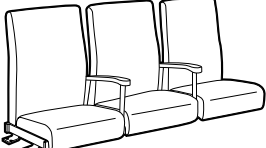
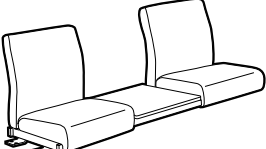
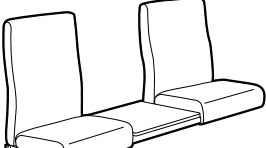
 <p><b>High Back Two Seat Bridge</b> Half Center Arm, Left &amp; Right COM Yardage: 4 Freight Class: 250 Product Weight (lbs.): 68 Cubic Feet Per Carton: 27.25</p>	<b>GC4264HB</b>	\$2691	\$2818	\$2922	\$3078	\$3295	\$3378	\$3569	\$3928	\$4110	\$4443	\$4906	\$5479
		<b>OVERALL DIMENSIONS</b> W D H			<b>SEAT DIMENSIONS</b> W D H			<b>BACK DIMENSIONS</b> W H					
		50.75	24	30.5	22	18	--	21.5	24.5				

DESCRIPTION	MODEL#	STANDARD FABRIC GRADES											
		COM	2	3	4	5	6	7	8	9	10	11	12
 <p><b>Low Back Three Seat Bridge</b> Half Center Arms, Left &amp; Right                      COM Yardage: 5                      Freight Class: 250                      Product Weight (lbs.): 78                      Cubic Feet Per Carton: 38.75</p>	<b>GC4265</b>	\$3846	\$4003	\$4135	\$4326	\$4601	\$4703	\$4943	\$5393	\$5618	\$6036	\$6615	\$7334
	Active weight 500 lbs./seat. <b>Not freestanding.</b> Suspends between 2 units via linking brackets. Wood armcap option - <b>Add \$83</b>	<b>OVERALL DIMENSIONS</b> W D H			<b>SEAT DIMENSIONS</b> W D H			<b>BACK DIMENSIONS</b> W H					
	74.25	24	25.5	22	18	--	21.5	19.5					
 <p><b>High Back Three Seat Bridge</b> Half Center Arms, Left &amp; Right                      COM Yardage: 5.75                      Freight Class: 250                      Product Weight (lbs.): 86                      Cubic Feet Per Carton: 38.75</p>	<b>GC4265HB</b>	\$4052	\$4234	\$4386	\$4607	\$4921	\$5039	\$5313	\$5831	\$6089	\$6570	\$7237	\$8062
	Active weight 500 lbs./seat. <b>Not freestanding.</b> Suspends between 2 units via linking brackets. Wood armcap option - <b>Add \$83</b>	<b>OVERALL DIMENSIONS</b> W D H			<b>SEAT DIMENSIONS</b> W D H			<b>BACK DIMENSIONS</b> W H					
	74.25	24	30.5	22	18	--	21.5	24.5					
 <p><b>Low Back Two Seat Armless Bridge</b> Center Table Top, Left &amp; Right                      COM Yardage: 3.5                      Freight Class: 300                      Product Weight (lbs.): 60                      Cubic Feet Per Carton: 38.75</p>	<b>GC4266</b>	\$3134	\$3245	\$3336	\$3471	\$3663	\$3736	\$3900	\$4218	\$4373	\$4667	\$5073	\$5574
	Active weight 500 lbs./seat. <b>Not freestanding.</b> Suspends between 2 units via linking brackets. • Table top only offered in High Pressure Laminate	<b>OVERALL DIMENSIONS</b> W D H			<b>SEAT DIMENSIONS</b> W D H			<b>BACK DIMENSIONS</b> W H					
	72.75	24	25.5	22	18	--	21.5	19.5					
 <p><b>High Back Two Seat Armless Bridge</b> Center Table Top, Left &amp; Right                      COM Yardage: 4                      Freight Class: 300                      Product Weight (lbs.): 66                      Cubic Feet Per Carton: 38.75</p>	<b>GC4266HB</b>	\$3270	\$3396	\$3501	\$3656	\$3873	\$3957	\$4148	\$4507	\$4688	\$5021	\$5485	\$6058
	Active weight 500 lbs./seat. <b>Not freestanding.</b> Suspends between 2 units via linking brackets. • Table top only offered in High Pressure Laminate	<b>OVERALL DIMENSIONS</b> W D H			<b>SEAT DIMENSIONS</b> W D H			<b>BACK DIMENSIONS</b> W H					
	72.75	24	30.5	22	18	--	21.5	24.5					
 <p><b>Bariatric Low Back Armless Bridge</b> Left &amp; Right                      COM Yardage: 3                      Freight Class: 300                      Product Weight (lbs.): 44                      Cubic Feet Per Carton: 26.5</p>	<b>GC4269</b>	\$1630	\$1725	\$1804	\$1921	\$2084	\$2145	\$2290	\$2560	\$2694	\$2946	\$3294	\$3724
	Active weight 750 lbs. <b>Not freestanding.</b> Suspends between 2 units via linking brackets.	<b>OVERALL DIMENSIONS</b> W D H			<b>SEAT DIMENSIONS</b> W D H			<b>BACK DIMENSIONS</b> W H					
	37.5	24	25.5	32.5	18	--	32.5	19.5					

DESCRIPTION	MODEL#	STANDARD FABRIC GRADES											
		COM	2	3	4	5	6	7	8	9	10	11	12

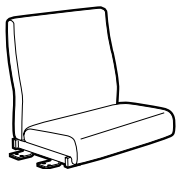

<b>GC4269HB</b>	<b>\$1734</b>	<b>\$1836</b>	<b>\$1923</b>	<b>\$2047</b>	<b>\$2227</b>	<b>\$2294</b>	<b>\$2449</b>	<b>\$2739</b>	<b>\$2885</b>	<b>\$3159</b>	<b>\$3536</b>	<b>\$3999</b>
-----------------	---------------	---------------	---------------	---------------	---------------	---------------	---------------	---------------	---------------	---------------	---------------	---------------

OVERALL DIMENSIONS			SEAT DIMENSIONS			BACK DIMENSIONS	
W	D	H	W	D	H	W	H

**Bariatric High Back Armless Bridge** Left & Right  
 COM Yardage: 3.25  
 Freight Class: 300  
 Product Weight (lbs.): 50  
 Cubic Feet Per Carton: 26.5

Active weight 750 lbs.  
**Not freestanding.**  
 Suspends between 2 units via linking brackets.

37.5	24	30.5	32.5	18	--	32.5	24.5
------	----	------	------	----	----	------	------

DESCRIPTION	MODEL#	STANDARD FABRIC GRADES											
		COM	2	3	4	5	6	7	8	9	10	11	12



<b>GC4271</b>	<b>\$1028</b>	<b>\$1074</b>	<b>\$1115</b>	<b>\$1172</b>	<b>\$1255</b>	<b>\$1284</b>	<b>\$1356</b>	<b>\$1492</b>	<b>\$1559</b>	<b>\$1686</b>	<b>\$1859</b>	<b>\$2074</b>
---------------	---------------	---------------	---------------	---------------	---------------	---------------	---------------	---------------	---------------	---------------	---------------	---------------

OVERALL DIMENSIONS			SEAT DIMENSIONS			BACK DIMENSIONS	
W	D	H	W	D	H	W	H

**Single Seat Bench Bridge** Left & Right  
 COM Yardage: 1.5  
 Freight Class: 100  
 Product Weight (lbs.): 24  
 Cubic Feet Per Carton: 2.9

Active weight 500 lbs.  
**Not freestanding.**  
 Suspends between 2 units via linking brackets.

24.75	26.5	6
-------	------	---

DESCRIPTION	MODEL#	STANDARD FABRIC GRADES											
		COM	2	3	4	5	6	7	8	9	10	11	12



<b>GC4272</b>	<b>\$1873</b>	<b>\$1942</b>	<b>\$2003</b>	<b>\$2089</b>	<b>\$2213</b>	<b>\$2258</b>	<b>\$2365</b>	<b>\$2568</b>	<b>\$2669</b>	<b>\$2858</b>	<b>\$3119</b>	<b>\$3442</b>
---------------	---------------	---------------	---------------	---------------	---------------	---------------	---------------	---------------	---------------	---------------	---------------	---------------

OVERALL DIMENSIONS			SEAT DIMENSIONS			BACK DIMENSIONS	
W	D	H	W	D	H	W	H

**Two Seat Bench Bridge** Left & Right  
 COM Yardage: 2.25  
 Freight Class: 125  
 Product Weight (lbs.): 64  
 Cubic Feet Per Carton: 9.25

Active weight 500 lbs./seat.  
**Not freestanding.**  
 Suspends between 2 units via linking brackets.

49.75	26.5	6
-------	------	---

DESCRIPTION	MODEL#	STANDARD FABRIC GRADES											
		COM	2	3	4	5	6	7	8	9	10	11	12

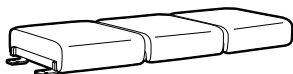

<b>GC4273</b>	<b>\$2775</b>	<b>\$2869</b>	<b>\$2949</b>	<b>\$3065</b>	<b>\$3229</b>	<b>\$3289</b>	<b>\$3434</b>	<b>\$3703</b>	<b>\$3838</b>	<b>\$4090</b>	<b>\$4438</b>	<b>\$4867</b>
---------------	---------------	---------------	---------------	---------------	---------------	---------------	---------------	---------------	---------------	---------------	---------------	---------------

OVERALL DIMENSIONS			SEAT DIMENSIONS			BACK DIMENSIONS	
W	D	H	W	D	H	W	H

**Three Seat Bench Bridge** Left & Right  
 COM Yardage: 3  
 Freight Class: 125  
 Product Weight (lbs.): 68  
 Cubic Feet Per Carton: 9.25

Active weight 500 lbs./seat.  
**Not freestanding.**  
 Suspends between 2 units via linking brackets.

72.75	26.5	6
-------	------	---

DESCRIPTION	MODEL#	STANDARD FABRIC GRADES											
		COM	2	3	4	5	6	7	8	9	10	11	12

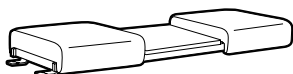

<b>GC4276</b>	<b>\$2611</b>	<b>\$2682</b>	<b>\$2743</b>	<b>\$2828</b>	<b>\$2952</b>	<b>\$2998</b>	<b>\$3105</b>	<b>\$3307</b>	<b>\$3410</b>	<b>\$3597</b>	<b>\$3859</b>	<b>\$4181</b>
---------------	---------------	---------------	---------------	---------------	---------------	---------------	---------------	---------------	---------------	---------------	---------------	---------------

OVERALL DIMENSIONS			SEAT DIMENSIONS			BACK DIMENSIONS	
W	D	H	W	D	H	W	H

**Two Seat Bench Bridge** Center Table Top, Left & Right  
 COM Yardage: 2.25  
 Freight Class: 250  
 Product Weight (lbs.): 32  
 Cubic Feet Per Carton: 9.25

Active weight 500 lbs./seat.  
**Not freestanding.**  
 Suspends between 2 units via linking brackets.  
 • Table top only offered in High Pressure Laminate

72.75	26	6
-------	----	---

DESCRIPTION	MODEL#	STANDARD FABRIC GRADES				
-------------	--------	------------------------	--	--	--	--

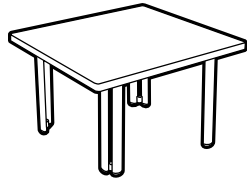

Rectangular End Table

GC4281-LP	22 x 18 x 16	100	30	3.4	<b>\$895</b>
GC4281-HP	22 x 18 x 16	100	30	3.4	<b>\$1012</b>

- For a thermally fused laminate top (LP), specify model GC4281-LP.
- For a high pressure laminate top (HP), specify model GC4281-HP.

1" thick top with coordinating 3mm edge. Oval steel tube legs

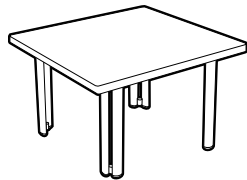

Square End Table

GC4288-LP	23 x 23 x 16	100	31	3.4	<b>\$1022</b>
GC4288-HP	23 x 23 x 16	100	31	3.4	<b>\$1136</b>

- For a thermally fused laminate top (LP), specify model GC4288-LP.
- For a high pressure laminate top (HP), specify model GC4288-HP.

1" thick top with coordinating 3mm edge. Oval steel tube legs.



Square End Table

GC4282-LP	30 x 30 x 16	150	34	6	<b>\$1147</b>
GC4282-HP	30 x 30 x 16	150	34	6	<b>\$1280</b>

- For a thermally fused laminate top (LP), specify model GC4282-LP.
- For a high pressure laminate top (HP), specify model GC4282-HP.

1" thick top with coordinating 3mm edge. Oval steel tube legs.

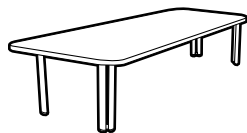

Rectangular Coffee Table

GC4283-LP	54 x 22 x 16	125	37	6	<b>\$1155</b>
GC4283-HP	54 x 22 x 16	125	37	6	<b>\$1347</b>

- For a thermally fused laminate top (LP), specify model GC4283-LP.
- For a high pressure laminate top (HP), specify model GC4283-HP.

1" thick top with coordinating 3mm edge. Oval steel tube legs



Square Coffee Table

GC4284-LP	36 x 36 x 16	125	37	6	<b>\$1205</b>
GC4284-HP	36 x 36 x 16	125	37	6	<b>\$1347</b>

- For a thermally fused laminate top (LP), specify model GC4284-LP.
- For a high pressure laminate top (HP), specify model GC4284-HP.

1" thick top with coordinating 3mm edge. Oval steel tube legs

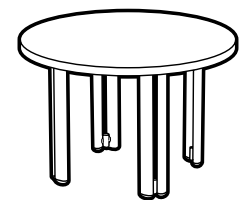

Round Coffee Table - 24" Diameter

GC4285-LP	24 x 24 x 16	100	33	3.4	<b>\$1123</b>
GC4285-HP	24 x 24 x 16	100	33	3.4	<b>\$1213</b>

- For a thermally fused laminate top (LP), specify model GC4285-LP.
- For a high pressure laminate top (HP), specify model GC4285-HP.

1" thick top with coordinating 3mm edge. Oval steel tube legs

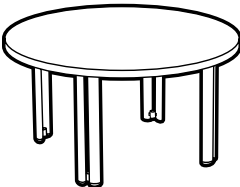
TABLES	MODEL#	DIMENSIONS	FREIGHT CLASS	WT/LBS.	CUBIC FT.	LIST PRICE
	GC4286-LP	30 x 30 x 16	150	34	6	<b>\$1127</b>
	GC4286-HP	30 x 30 x 16	150	34	6	<b>\$1213</b>

Round Coffee Table - 30" Diameter

- For a thermally fused laminate top (LP), specify model GC4286-LP.
- For a high pressure laminate top (HP), specify model GC4286-HP.

1" thick top with coordinating 3mm edge. Oval steel tube legs

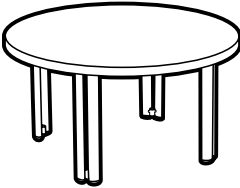
	GC4287-LP	36 x 36 x 16	125	37	6	<b>\$1276</b>
	GC4287-HP	36 x 36 x 16	125	37	6	<b>\$1416</b>

Round Coffee Table 36" Diameter

- For a thermally fused laminate top (LP), specify model GC4287-LP.
- For a high pressure laminate top (HP), specify model GC4287-HP.

1" thick top with coordinating 3mm edge. Oval steel tube legs

TABLE BRIDGES	MODEL#	DIMENSIONS	FREIGHT CLASS	WT/LBS.	CUBIC FT.	LIST PRICE
---------------	--------	------------	---------------	---------	-----------	------------

	GC4274-LP	23 x 23 x 16	125	25	3.4	<b>\$736</b>
	GC4274-HP	23 x 23 x 16	125	25	3.4	<b>\$787</b>

End Table Bridge, Not Freestanding

- For a thermally fused laminate top (LP), specify model GC4274-LP.
- For a high pressure laminate top (HP), specify model GC4274-HP.

1 end suspends to a seating unit via linking brackets. 1" thick top with coordinating 3mm edge. Oval steel tube legs Reversible.

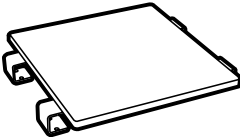
	GC4275-LP	23 x 23 x 1	150	18	3.4	<b>\$514</b>
	GC4275-HP	23 x 23 x 1	150	18	3.4	<b>\$579</b>

Square Table Top, Not Freestanding

- For a thermally fused laminate top (LP), specify model GC4275-LP.
- For a high pressure laminate top (HP), specify model GC4275-HP.

Suspends between two seating units via linking brackets. 1" thick top with coordinating 3mm edge. No legs. Reversible.

	GC4277-LP	35 x 35 x 16	125	45	6	<b>\$820</b>
	GC4277-HP	35 x 35 x 16	125	45	6	<b>\$936</b>

End Corner Table Bridge Not Freestanding

- For a thermally fused laminate top (LP), specify model GC4277-LP.
- For a high pressure laminate top (HP), specify model GC4277-HP.

Suspends between two seating units via linking brackets. 1" thick top with coordinating 3mm edge. Oval steel tube legs Can be used for right or left corner.

	GC4278-LP	35 x 35 x 16	125	45	6	<b>\$820</b>
	GC4278-HP	35 x 35 x 16	125	45	6	<b>\$936</b>

End Corner Curve Table Bridge Not Freestanding

- For a thermally fused laminate top (LP), specify model GC4278-LP.
- For a high pressure laminate top (HP), specify model GC4278-HP.

Suspends between two seating units via linking brackets. 1" thick top with coordinating 3mm edge. Oval steel tube legs Can be used for right or left corner.

TABLES	MODEL#	DIMENSIONS	FREIGHT CLASS	WT/LBS.	CUBIC FT.	LIST PRICE
--------	--------	------------	---------------	---------	-----------	------------

GC-CITI



model GC7875

STANDARD FEATURES

- Fully upholstered contemporary design, complements timeless decor. Proportions are compact, 31" deep, works well in public spaces, lounges and lobbies.
- The steel leg brings a lightness of scale, while satisfying the need for accessibility
- GC Citi seat legs are 5" high tubular metal, standard in a Tungsten finish.
- The seat is fastened into place and removable over an open frame structure eliminating all barriers and traps below the surface.
- The seat cushion is fully encased by the upholstery with a nylon zippered opening for access if replacement is required. This method of upholstery when using Crypton or vinyl textiles prevents the interior construction from contact with spills and body fluids that could affect the products long-term performance
- Models have removable cushions. Cushions feature removable covers
- The interior wood frame has an interlocking construction providing superior strength and long-term durability
- Arm height on all models is 25"
- Casters are not available on this series
- For added comfort, seats are standard with high density Ultracell foam
- For Globalcare textiles and finish options, visit the website at [www.globalfurnituregroup.com](http://www.globalfurnituregroup.com)
- Can be upholstered in standard Global textiles only if Healthcare compliance is not required.
- Shipped fully assembled

SUGGESTED APPLICATIONS

- Guest seating
- Lobbies
- Lounge/Waiting
- Resident rooms

DESCRIPTION	MODEL#	STANDARD FABRIC GRADES											
		COM	2	3	4	5	6	7	8	9	10	11	12
	GC7875	\$1820	\$1983	\$2118	\$2318	\$2599	\$2733	\$2987	\$3396	\$3709	\$4059	\$4779	\$5546



**Lounge Chair**  
 COM Yardage: 4.75  
 Freight Class: 250  
 Product Weight (lbs.): 67  
 Cubic Feet Per Carton: 21

Active weight 300 lbs.

OVERALL DIMENSIONS			SEAT DIMENSIONS			BACK DIMENSIONS	
W	D	H	W	D	H	W	H
30	31	30	22	19.5	17.5	22	12.5

GC-COMET



model GC2180 (TUN)



Black Plastic Arms



Wallsaver Leg

STANDARD FEATURES

- The rounded steel frame and durable seat cushion will ensure years of use.
- Black plastic arms are standard.
- This bariatric model has been specially designed in consultation with healthcare specialists to meet the needs of larger individuals.
- Reinforced steel seat frame accommodates users up to 500 pounds.
- For added comfort, seats are standard with high density Ultracell bio foam.
- The steel frame is available in Black (BLK), Shadow (SHW), Toast (TOA), Tungsten (TUN), Latte (LAB), Mocha (J52), and Kalua (KAL). Please specify.
- Standard glide is a plastic dome shape on back legs, flat glide on front legs.
- Bariatric models stack 2 high on floor. No dolly available.
- For Globalcare textiles and finish options, visit the website at [globalfurnituregroup.com](http://globalfurnituregroup.com)
- Can be upholstered in standard Global textiles only if Healthcare compliance is not required.
- Shipped fully assembled

OPTIONAL FEATURES

- Plastic arms available in Shadow (SHW) and Toast (TOA). Please specify. Add \$40.
- A selection of glide options is available. Glides must be chosen to best suit flooring type and site conditions.
- Steel cushioned glides (B) are available - Add \$28.
- Glides with felt pads (FG) are available for vinyl sheet, cork or laminate flooring. Please specify. Add \$55.
- Glides with rubber pads (RG) are available for vinyl, hardwood, laminate, stone or ceramic flooring. Please specify. Add \$55.
- For moisture barrier on seat - Add \$178.

SUGGESTED APPLICATIONS

- Bariatric seating
- Patient Rooms
- Waiting Areas
- Exam Rooms
- Guest Seating
- Dining Rooms

DESCRIPTION	MODEL#	STANDARD FABRIC GRADES																																	
		COM	2	3	4	5	6	7	8	9	10	11	12																						
 <p><b>Bariatric Lounge Chair</b>                      COM Yardage: 1.75                      Freight Class: 300                      Product Weight (lbs.): 44                      Cubic Feet Per Carton: 23</p>	GC2180	\$1149	\$1203	\$1249	\$1317	\$1413	\$1448	\$1533	\$1690	\$1768	\$1917	\$2118	\$2368																						
		<table border="1"> <thead> <tr> <th colspan="3">OVERALL DIMENSIONS</th> <th colspan="3">SEAT DIMENSIONS</th> <th colspan="2">BACK DIMENSIONS</th> </tr> <tr> <th>W</th> <th>D</th> <th>H</th> <th>W</th> <th>D</th> <th>H</th> <th>W</th> <th>H</th> </tr> </thead> <tbody> <tr> <td>31.5</td> <td>27</td> <td>38</td> <td>26.5</td> <td>18.5</td> <td>18</td> <td>26.5</td> <td>20</td> </tr> </tbody> </table>												OVERALL DIMENSIONS			SEAT DIMENSIONS			BACK DIMENSIONS		W	D	H	W	D	H	W	H	31.5	27	38	26.5	18.5	18
OVERALL DIMENSIONS			SEAT DIMENSIONS			BACK DIMENSIONS																													
W	D	H	W	D	H	W	H																												
31.5	27	38	26.5	18.5	18	26.5	20																												
		Active weight 500 lbs.																																	

## GC ISLANDS



model GC4075



model GC4076

### STANDARD FEATURES



- GC Islands offers wood guest seating with contemporary styling.
- Two back styles: Upholstered back pad or horizontal wood slat back.
- Legs are equipped with White non-marking polypropylene glides. Suitable for both carpet and hard surface flooring.
- All cushions are fixed and non-removable.
- Cushions are made with highly resilient foam and seats are equipped with a synthetic rubberized webbing suspension system for extra comfort
- Seat cushion underside is finished with a Black impermeable surface material
- Does not stack
- For Globalcare textiles and finish options, visit the website at [globalfurnituregroup.com](http://globalfurnituregroup.com).
- Can be upholstered in standard Global textiles if Healthcare compliance is not required.

### OPTIONAL FEATURES

- Wood frame available in Absolute (AAM), Black (BKM), Cherry (ACM), English Oak (EOM), Espresso Cafe (ECM), Fruitwood (TFM), Gray (HGM), Honey (AHM), Mahogany (TMM), Maple (AVM), Medium Walnut (MWM), Natural Walnut (NLW), Night (ASM), Noce Biondo (NBM), Noce Grigio (NGM), Noce Leggero (NEM), Noce Medio (NMM), Sandy Beach (SKM), Shaker Cherry (SKM), Silver Oak (SOM), Walnut (TWM), WC Cream (WTM), White (WHM) and Winter Cherry (WCM). Please specify.
- For moisture barrier on seat, please specify **(MB)**. - Add **\$119** per seat.
- Back sealed seam available, please specify **(S2)**. Add **\$35**.

### SUGGESTED APPLICATIONS

- Dining/Cafeteria
- Guest seating
- Lobbies
- Lounge/Waiting
- Office/Meeting
- Patient rooms
- Resident rooms

DESCRIPTION	MODEL#	STANDARD FABRIC GRADES											
		COM	2	3	4	5	6	7	8	9	10	11	12
 <p><b>Armchair w/Upholstered Back</b> COM Yardage: 1.5 Freight Class: 300 Product Weight (lbs.): 25 Cubic Feet Per Carton: 13.25</p>	GC4075	\$940	\$982	\$1022	\$1083	\$1166	\$1203	\$1273	\$1393	\$1486	\$1587	\$1796	\$2014
		<b>OVERALL DIMENSIONS</b>			<b>SEAT DIMENSIONS</b>			<b>BACK DIMENSIONS</b>					
		W	D	H	W	D	H	W	H				
			24.5	23.5	32	20.5	18	18.5	19	13			
 <p><b>Armchair w/Horizontal Wood Slat Back</b> COM Yardage: 1 Freight Class: 300 Product Weight (lbs.): 25 Cubic Feet Per Carton: 13.25</p>	GC4076	\$1016	\$1046	\$1072	\$1116	\$1173	\$1196	\$1248	\$1324	\$1387	\$1449	\$1595	\$1740
		<b>OVERALL DIMENSIONS</b>			<b>SEAT DIMENSIONS</b>			<b>BACK DIMENSIONS</b>					
		W	D	H	W	D	H	W	H				
			24.5	23.5	32	20.5	18	18.5	19	13			



GC SIDERO™



model GC6923

STANDARD FEATURES

- GC Sidero is a collection of contemporary multi-purpose stacking chairs with a sculptured look, featuring wide, curved arms and a round tubular wallsaver steel frame.
- Available in arm and armless models (except on bariatric models) with three seat widths, two back heights, and a four-legged and sled base frame.
- Offers options that allow the chair to meet rigorous infection prevention control requirements.
- Compound curved back provides comfort and support in multiple seating positions
- Rugged steel frame made from round welded steel tubing 7/8" dia. Available in Black (BLK), Latte (LAB), Kalua (KAL), Mocha (J52), Shadow (SHW), Toast (TOA) and Tungsten (TUN).
- Frames feature a wall saver design to prevent back contact with wall
- Standard glide is durable Black polypropylene
- For added comfort, seats are standard with high density Ultracell bio foam
- Three seat widths: 19.5" (standard size), 24" (mid size) and 30" (bariatric).
- Two different back constructions are offered:
  1. Concealed back attachment: two piece back covering the back support brackets when fastened in place.
  2. Single piece back with a pullover style upholstery cover and support bracket fastened on the outer back.
- Low back and high back models are available:
  1. Low back version is available on all three seat widths: 15.5" high.
  2. High back version on 19" and 24" seat widths: 21" high.
  3. High back version on bariatric 30" seat width: 21.75" high.
- Fiberglass nylon reinforced arms have a generous width and extend to the front of the seat. They offer additional support and help to stabilize users as they sit or exit the chair. Available in Black only.
- Select GC Sidero models are equipped with a polypropylene seat shroud that helps avoid frame imprints on upholstered seats when chairs are stacked. Protective seat shroud is standard on all 19.5" seat width models.
- 30" Bariatric and 24" seat width models do not have a seat shroud and are standard with a vinyl covered seat underside.
- Active weight capacity for 19.5" seat width models is up to 300 lbs., and up to 500 lbs for 24" seat width and Bariatric models.
- For healthcare textiles and finish options, visit the website at [globalfurnituregroup.com](http://globalfurnituregroup.com).
- Can be upholstered in standard Global textiles if healthcare compliance is not required.





OPTIONAL FEATURES

- To respond to higher expectations for housekeeping and infection prevention, single piece back underside and all seat pan undersides can be completely sealed and seat shroud (if standard on the model) would be removed.
  - For standard models with single piece back, please specify (BSS). Add \$66.
  - For standard models with concealed attachment back, please specify (STS). Add \$43.
  - For 24" width models with single piece back, please specify (BSS). Add \$77.
  - For 24" width models with concealed attachment back, please specify (STS). Add \$60.
  - For bariatric models with single piece back, please specify (BSS). Add \$94.
  - For bariatric models with concealed attachment back, please specify (STS). Add \$61.
- Chrome frame available, please specify (CHM). Add \$40 list upcharge.
- A selection of glide options is available. Glides must be chosen to best suit flooring type and site conditions.
- For hard surface floors, please specify opaque non-marking glides (NM). No upcharge.
- Steel cushioned glides (B) are available on four legged models. Add \$28 list upcharge.
- Glides with felt pads (FG) are available for vinyl sheet, cork or laminate flooring. Please specify. Add \$55.
- Glides with rubber pads (RG) are available for vinyl, hardwood, laminate, stone or ceramic flooring. Please specify. Add \$55.
- Seams can be sealed to prevent penetration of fluids through the stitching. Sealed seams are only available with select textiles. Please contact CustomerCare for more information.
- Moisture Barrier for 19.5" seat width - Add \$119 list upcharge per seat. For 24" seat width models - Add \$119 list upcharge per seat.. For Bariatric models - Add \$183 list upcharge per seat.

SUGGESTED APPLICATIONS

- Bariatric seating (some models)
- Dining/Cafeteria
- Guest seating
- Lobbies
- Lounge/Waiting
- Office/Meeting
- Patient rooms
- Resident rooms
- Stacking
- Treatment/Exam rooms

SEAT WIDTH	STACKING CAPABILITIES
19.5"	Four-legged armchairs and side chairs can stack up to 5 high on the floor or 8 high on dolly #2125WS. Sled base armchairs and side chairs do not stack.
24" midsize	Four-legged armchairs and side chairs can stack up to 5 high on the floor. No dolly is available. Sled base armchairs and side chairs do not stack.
30" bariatric	Four-legged armchairs can stack up to 2 high on the floor. No dolly is available. Sled base models do not stack.

DESCRIPTION	MODEL#	STANDARD FABRIC GRADES											
		COM	2	3	4	5	6	7	8	9	10	11	12
 <p><b>LB Stacking Armchair, 4 Leg Base</b> with concealed attachment                      COM Yardage: 1.25                      Freight Class: 250                      Product Weight (lbs.): 29                      Cubic Feet Per Carton: 13.5</p>	GC6900	\$624	\$684	\$734	\$806	\$911	\$960	\$1054	\$1206	\$1322	\$1449	\$1714	\$1998
		OVERALL DIMENSIONS			SEAT DIMENSIONS			BACK DIMENSIONS					
		W	D	H	W	D	H	W	H				
 <p><b>HB Stacking Armchair, 4 Leg Base</b> with concealed attachment                      COM Yardage: 1.75                      Freight Class: 250                      Product Weight (lbs.): 33                      Cubic Feet Per Carton: 15.25</p>	GC6900HB	\$759	\$826	\$884	\$967	\$1087	\$1142	\$1248	\$1421	\$1554	\$1700	\$2003	\$2325
		OVERALL DIMENSIONS			SEAT DIMENSIONS			BACK DIMENSIONS					
		W	D	H	W	D	H	W	H				
 <p><b>LB Stacking Chair, 4 Leg Base</b> with concealed attachment                      COM Yardage: 1.25                      Freight Class: 250                      Product Weight (lbs.): 26                      Cubic Feet Per Carton: 11.25</p>	GC6901	\$586	\$645	\$695	\$770	\$872	\$921	\$1015	\$1167	\$1283	\$1412	\$1676	\$1960
		OVERALL DIMENSIONS			SEAT DIMENSIONS			BACK DIMENSIONS					
		W	D	H	W	D	H	W	H				
 <p><b>HB Stacking Chair, 4 Leg Base</b> with concealed attachment                      COM Yardage: 1.75                      Freight Class: 250                      Product Weight (lbs.): 30                      Cubic Feet Per Carton: 14.5</p>	GC6901HB	\$720	\$787	\$846	\$928	\$1049	\$1103	\$1213	\$1383	\$1515	\$1661	\$1965	\$2288
		OVERALL DIMENSIONS			SEAT DIMENSIONS			BACK DIMENSIONS					
		W	D	H	W	D	H	W	H				
 <p><b>LB Armchair, Sled Base</b> with concealed attachment                      COM Yardage: 1.25                      Freight Class: 250                      Product Weight (lbs.): 32                      Cubic Feet Per Carton: 13.5</p>	GC6902	\$821	\$881	\$931	\$1004	\$1108	\$1157	\$1251	\$1403	\$1520	\$1649	\$1912	\$2195
		OVERALL DIMENSIONS			SEAT DIMENSIONS			BACK DIMENSIONS					
		W	D	H	W	D	H	W	H				

DESCRIPTION	MODEL#	STANDARD FABRIC GRADES											
		COM	2	3	4	5	6	7	8	9	10	11	12
 <p><b>HB Armchair, Sled Base</b> with concealed attachment COM Yardage: 1.75 Freight Class: 250 Product Weight (lbs.): 36 Cubic Feet Per Carton: 15.25</p>	<b>GC6902HB</b>	<b>\$887</b>	<b>\$954</b>	<b>\$1013</b>	<b>\$1095</b>	<b>\$1215</b>	<b>\$1270</b>	<b>\$1377</b>	<b>\$1549</b>	<b>\$1681</b>	<b>\$1828</b>	<b>\$2132</b>	<b>\$2454</b>
		<b>OVERALL DIMENSIONS</b>			<b>SEAT DIMENSIONS</b>			<b>BACK DIMENSIONS</b>					
		<b>W</b>	<b>D</b>	<b>H</b>	<b>W</b>	<b>D</b>	<b>H</b>	<b>W</b>	<b>H</b>				
		25.5	24	38.5	19.5	18	17.5	19	21				

Active weight 300 lbs.  
**Does not stack.**

DESCRIPTION	MODEL#	STANDARD FABRIC GRADES											
		COM	2	3	4	5	6	7	8	9	10	11	12
 <p><b>LB Side Chair, Sled Base</b> with concealed attachment COM Yardage: 1.25 Freight Class: 250 Product Weight (lbs.): 30 Cubic Feet Per Carton: 11.25</p>	<b>GC6903</b>	<b>\$779</b>	<b>\$837</b>	<b>\$888</b>	<b>\$962</b>	<b>\$1064</b>	<b>\$1113</b>	<b>\$1208</b>	<b>\$1359</b>	<b>\$1476</b>	<b>\$1605</b>	<b>\$1868</b>	<b>\$2152</b>
		<b>OVERALL DIMENSIONS</b>			<b>SEAT DIMENSIONS</b>			<b>BACK DIMENSIONS</b>					
		<b>W</b>	<b>D</b>	<b>H</b>	<b>W</b>	<b>D</b>	<b>H</b>	<b>W</b>	<b>H</b>				
		21	24	33	19.5	18	17.5	19	15.5				

Active weight 300 lbs.  
**Does not stack.**

DESCRIPTION	MODEL#	STANDARD FABRIC GRADES											
		COM	2	3	4	5	6	7	8	9	10	11	12
 <p><b>HB Side Chair, Sled Base</b> with concealed attachment COM Yardage: 1.75 Freight Class: 250 Product Weight (lbs.): 34 Cubic Feet Per Carton: 14.5</p>	<b>GC6903HB</b>	<b>\$925</b>	<b>\$991</b>	<b>\$1050</b>	<b>\$1134</b>	<b>\$1252</b>	<b>\$1307</b>	<b>\$1414</b>	<b>\$1587</b>	<b>\$1718</b>	<b>\$1866</b>	<b>\$2169</b>	<b>\$2491</b>
		<b>OVERALL DIMENSIONS</b>			<b>SEAT DIMENSIONS</b>			<b>BACK DIMENSIONS</b>					
		<b>W</b>	<b>D</b>	<b>H</b>	<b>W</b>	<b>D</b>	<b>H</b>	<b>W</b>	<b>H</b>				
		21	24	38.5	19.5	18	17.5	19	21				





Active weight 300 lbs.  
**Does not stack.**

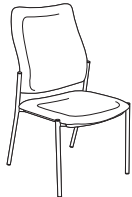



DESCRIPTION	MODEL#	STANDARD FABRIC GRADES											
		COM	2	3	4	5	6	7	8	9	10	11	12
 <p><b>Low Back Stacking Chair 4 Leg Base</b> COM Yardage: 1.25 Freight Class: 250 Product Weight (lbs.): 26 Cubic Feet Per Carton: 11.25</p>	<b>GC6912</b>	<b>\$604</b>	<b>\$645</b>	<b>\$684</b>	<b>\$735</b>	<b>\$808</b>	<b>\$844</b>	<b>\$912</b>	<b>\$1019</b>	<b>\$1101</b>	<b>\$1192</b>	<b>\$1382</b>	<b>\$1584</b>
		<b>OVERALL DIMENSIONS</b>			<b>SEAT DIMENSIONS</b>			<b>BACK DIMENSIONS</b>					
		<b>W</b>	<b>D</b>	<b>H</b>	<b>W</b>	<b>D</b>	<b>H</b>	<b>W</b>	<b>H</b>				
		21	24	33	19.5	18	17.5	19	15.5				





Active weight 300 lbs.  
Single piece back with pullover style upholstery cover with **exposed support brackets** on the outer back.

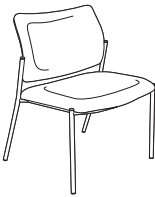



DESCRIPTION	MODEL#	STANDARD FABRIC GRADES											
		COM	2	3	4	5	6	7	8	9	10	11	12
 <p><b>High Back Stacking Chair 4 Leg Base</b> COM Yardage: 1.75 Freight Class: 250 Product Weight (lbs.): 30 Cubic Feet Per Carton: 14.5</p>	<b>GC6912HB</b>	<b>\$728</b>	<b>\$787</b>	<b>\$837</b>	<b>\$912</b>	<b>\$1014</b>	<b>\$1063</b>	<b>\$1157</b>	<b>\$1309</b>	<b>\$1426</b>	<b>\$1555</b>	<b>\$1818</b>	<b>\$2102</b>
		<b>OVERALL DIMENSIONS</b>			<b>SEAT DIMENSIONS</b>			<b>BACK DIMENSIONS</b>					
		<b>W</b>	<b>D</b>	<b>H</b>	<b>W</b>	<b>D</b>	<b>H</b>	<b>W</b>	<b>H</b>				
		21	24	38.5	19.5	18	17.5	19	21				

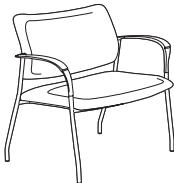

Active weight 300 lbs.  
Single piece back with pullover style upholstery cover with **exposed support brackets** on the outer back.

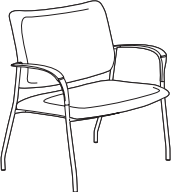
DESCRIPTION	MODEL#	STANDARD FABRIC GRADES											
		COM	2	3	4	5	6	7	8	9	10	11	12
 <p><b>LB Stacking Armchair, 4 Leg Base</b> COM Yardage: 1.25 Freight Class: 250 Product Weight (lbs.): 29 Cubic Feet Per Carton: 13.5</p>	<b>GC6913</b>	\$643	\$684	\$719	\$774	\$847	\$883	\$951	\$1057	\$1140	\$1231	\$1421	\$1623
		<b>OVERALL DIMENSIONS</b>			<b>SEAT DIMENSIONS</b>			<b>BACK DIMENSIONS</b>					
		<b>W</b>	<b>D</b>	<b>H</b>	<b>W</b>	<b>D</b>	<b>H</b>	<b>W</b>	<b>H</b>				
		25.5	24	33	19.5	18	17.5	19	15.5				
Active weight 300 lbs. Single piece back with pullcover style upholstery cover with <b>exposed support brackets</b> on the outer back.													
 <p><b>HB Stacking Armchair, 4 Leg Base</b> COM Yardage: 1.75 Freight Class: 250 Product Weight (lbs.): 33 Cubic Feet Per Carton: 15.25</p>	<b>GC6913HB</b>	\$766	\$826	\$876	\$949	\$1053	\$1102	\$1196	\$1348	\$1464	\$1591	\$1857	\$2140
		<b>OVERALL DIMENSIONS</b>			<b>SEAT DIMENSIONS</b>			<b>BACK DIMENSIONS</b>					
		<b>W</b>	<b>D</b>	<b>H</b>	<b>W</b>	<b>D</b>	<b>H</b>	<b>W</b>	<b>H</b>				
		25.5	24	38.5	19.5	18	17.5	19	21				
Active weight 300 lbs. Single piece back with pullcover style upholstery cover with <b>exposed support brackets</b> on the outer back.													
 <p><b>LB Armchair, Sled Base</b> COM Yardage: 1.75 Freight Class: 250 Product Weight (lbs.): 32 Cubic Feet Per Carton: 13.5</p>	<b>GC6914</b>	\$840	\$881	\$920	\$971	\$1045	\$1080	\$1148	\$1255	\$1337	\$1430	\$1618	\$1821
		<b>OVERALL DIMENSIONS</b>			<b>SEAT DIMENSIONS</b>			<b>BACK DIMENSIONS</b>					
		<b>W</b>	<b>D</b>	<b>H</b>	<b>W</b>	<b>D</b>	<b>H</b>	<b>W</b>	<b>H</b>				
		25.5	24	33	19.5	18	17.5	19	15.5				
Active weight 300 lbs. Single piece back with pullcover style upholstery cover with <b>exposed support brackets</b> on the outer back.													
 <p><b>LB Armchair, Sled Base</b> COM Yardage: 1.75 Freight Class: 250 Product Weight (lbs.): 36 Cubic Feet Per Carton: 15.25</p>	<b>GC6914HB</b>	\$974	\$1032	\$1083	\$1157	\$1261	\$1312	\$1405	\$1554	\$1671	\$1800	\$2063	\$2348
		<b>OVERALL DIMENSIONS</b>			<b>SEAT DIMENSIONS</b>			<b>BACK DIMENSIONS</b>					
		<b>W</b>	<b>D</b>	<b>H</b>	<b>W</b>	<b>D</b>	<b>H</b>	<b>W</b>	<b>H</b>				
		25.5	24	38.5	19.5	18	17.5	19	21				
Active weight 300 lbs. Single piece back with pullcover style upholstery cover with <b>exposed support brackets</b> on the outer back. <b>Does not stack.</b>													
 <p><b>Low Back Side Chair, Sled Base</b> COM Yardage: 1.25 Freight Class: 250 Product Weight (lbs.): 30 Cubic Feet Per Carton: 11.25</p>	<b>GC6915</b>	\$796	\$837	\$876	\$927	\$1001	\$1037	\$1104	\$1212	\$1294	\$1386	\$1576	\$1777
		<b>OVERALL DIMENSIONS</b>			<b>SEAT DIMENSIONS</b>			<b>BACK DIMENSIONS</b>					
		<b>W</b>	<b>D</b>	<b>H</b>	<b>W</b>	<b>D</b>	<b>H</b>	<b>W</b>	<b>H</b>				
		21	24	33	19.5	18	17.5	19	15.5				
Active weight 300 lbs. Single piece back with pullcover style upholstery cover with <b>exposed support brackets</b> on the outer back. <b>Does not stack.</b>													



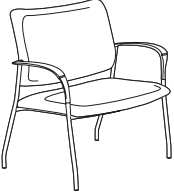
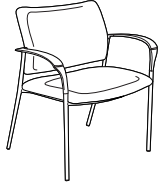

DESCRIPTION	MODEL#	STANDARD FABRIC GRADES											
		COM	2	3	4	5	6	7	8	9	10	11	12
 <p><b>HB Side Chair, Sled Base</b> COM Yardage: 1.75 Freight Class: 250 Product Weight (lbs.): 34 Cubic Feet Per Carton: 14.5</p>	<b>GC6915HB</b>	\$932	\$991	\$1042	\$1114	\$1220	\$1269	\$1362	\$1512	\$1629	\$1758	\$2022	\$2306
		OVERALL DIMENSIONS			SEAT DIMENSIONS			BACK DIMENSIONS					
		W	D	H	W	D	H	W	H				
		21	24	38.5	19.5	18	17.5	19	21				
		Active weight 300 lbs. Single piece back with pullover style upholstery cover with <b>exposed support brackets</b> on the outer back.											
 <p><b>LB Midsize Stacking Armchair, 4 Leg Base</b> COM Yardage: 1.75 Freight Class: 250 Product Weight (lbs.): 34 Cubic Feet Per Carton: 16.</p>	<b>GC6916</b>	\$934	\$993	\$1044	\$1116	\$1222	\$1271	\$1364	\$1515	\$1632	\$1760	\$2024	\$2308
		OVERALL DIMENSIONS			SEAT DIMENSIONS			BACK DIMENSIONS					
		W	D	H	W	D	H	W	H				
		30.5	24	33	24	18	17.5	24	15.5				
		Active weight 500 lbs. Single piece back with pullover style upholstery cover with <b>exposed support brackets</b> on the outer back.											
 <p><b>HB Midsize Stacking Armchair, 4 Leg Base</b> COM Yardage: 2 Freight Class: 250 Product Weight (lbs.): 37 Cubic Feet Per Carton: 18.25</p>	<b>GC6916HB</b>	\$1069	\$1136	\$1194	\$1277	\$1397	\$1451	\$1558	\$1731	\$1862	\$2010	\$2313	\$2635
		OVERALL DIMENSIONS			SEAT DIMENSIONS			BACK DIMENSIONS					
		W	D	H	W	D	H	W	H				
		30.5	24	38.5	24	18	17.5	24	21				
		Active weight 500 lbs. Single piece back with pullover style upholstery cover with <b>exposed support brackets</b> on the outer back.											
 <p><b>LB Midsize Stacking Chair, 4 Leg Base</b> COM Yardage: 1.75 Freight Class: 250 Product Weight (lbs.): 30 Cubic Feet Per Carton: 14.5</p>	<b>GC6917</b>	\$896	\$955	\$1005	\$1078	\$1182	\$1231	\$1325	\$1477	\$1593	\$1722	\$1985	\$2270
		OVERALL DIMENSIONS			SEAT DIMENSIONS			BACK DIMENSIONS					
		W	D	H	W	D	H	W	H				
		26	24	33	24	18	17.5	24	15.5				
		Active weight 500 lbs. Single piece back with pullover style upholstery cover with <b>exposed support brackets</b> on the outer back.											
 <p><b>HB Midsize Stacking Chair, 4 Leg Base</b> COM Yardage: 2 Freight Class: 300 Product Weight (lbs.): 33 Cubic Feet Per Carton: 17.75</p>	<b>GC6917HB</b>	\$1029	\$1096	\$1155	\$1237	\$1357	\$1412	\$1519	\$1691	\$1824	\$1970	\$2274	\$2596
		OVERALL DIMENSIONS			SEAT DIMENSIONS			BACK DIMENSIONS					
		W	D	H	W	D	H	W	H				
		26	24	38.5	24	18	17.5	24	21				
		Active weight 500 lbs. Single piece back with pullover style upholstery cover with <b>exposed support brackets</b> on the outer back.											

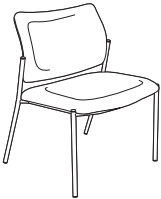
DESCRIPTION	MODEL#	STANDARD FABRIC GRADES											
		COM	2	3	4	5	6	7	8	9	10	11	12
 <b>LB Midsize Armchair, Sled Base</b> COM Yardage: 1.75 Freight Class: 250 Product Weight (lbs.): 36 Cubic Feet Per Carton: 16	<b>GC6918</b>	\$1154	\$1213	\$1263	\$1338	\$1442	\$1491	\$1584	\$1735	\$1852	\$1980	\$2244	\$2528
	<b>OVERALL DIMENSIONS</b>			<b>SEAT DIMENSIONS</b>			<b>BACK DIMENSIONS</b>						
	W	D	H	W	D	H	W	H					
	30.5	24	33	24	18	17.5	24	15.5					
Active weight 500 lbs. Single piece back with pullover style upholstery cover with <b>exposed support brackets</b> on the outer back.													
 <b>HB Midsize Armchair, Sled Base</b> COM Yardage: 2 Freight Class: 250 Product Weight (lbs.): 39 Cubic Feet Per Carton: 18.25	<b>GC6918HB</b>	\$1299	\$1366	\$1425	\$1507	\$1628	\$1682	\$1789	\$1961	\$2093	\$2241	\$2544	\$2866
	<b>OVERALL DIMENSIONS</b>			<b>SEAT DIMENSIONS</b>			<b>BACK DIMENSIONS</b>						
	W	D	H	W	D	H	W	H					
	30.5	24	38.5	24	18	17.5	24	21					
Active weight 500 lbs. Single piece back with pullover style upholstery cover with <b>exposed support brackets</b> on the outer back.													
 <b>LB Midsize Side Chair, Sled Base</b> COM Yardage: 1.75 Freight Class: 250 Product Weight (lbs.): 34 Cubic Feet Per Carton: 14.5	<b>GC6919</b>	\$1114	\$1172	\$1222	\$1298	\$1401	\$1450	\$1543	\$1694	\$1811	\$1940	\$2203	\$2488
	<b>OVERALL DIMENSIONS</b>			<b>SEAT DIMENSIONS</b>			<b>BACK DIMENSIONS</b>						
	W	D	H	W	D	H	W	H					
	26	24	33	24	18	17.5	24	15.5					
Active weight 500 lbs. Single piece back with pullover style upholstery cover with <b>exposed support brackets</b> on the outer back.													
 <b>HB Midsize Side Chair, Sled Base</b> COM Yardage: 2 Freight Class: 250 Product Weight (lbs.): 37 Cubic Feet Per Carton: 17.75	<b>GC6919HB</b>	\$1260	\$1327	\$1385	\$1468	\$1588	\$1642	\$1750	\$1923	\$2054	\$2201	\$2504	\$2826
	<b>OVERALL DIMENSIONS</b>			<b>SEAT DIMENSIONS</b>			<b>BACK DIMENSIONS</b>						
	W	D	H	W	D	H	W	H					
	26	24	38.5	24	18	17.5	24	21					
Active weight 500 lbs. Single piece back with pullover style upholstery cover with <b>exposed support brackets</b> on the outer back.													
 <b>LB Bariatric Stacking Armchair, 4 Leg Base</b> COM Yardage: 2.5 Freight Class: 250 Product Weight (lbs.): 46 Cubic Feet Per Carton: 20.5	<b>GC6920</b>	\$1241	\$1326	\$1396	\$1501	\$1651	\$1721	\$1855	\$2070	\$2235	\$2418	\$2798	\$3202
	<b>OVERALL DIMENSIONS</b>			<b>SEAT DIMENSIONS</b>			<b>BACK DIMENSIONS</b>						
	W	D	H	W	D	H	W	H					
	36.5	26	33	30	18	17.5	30	15.5					
Active weight 500 lbs. Single piece back with pullover style upholstery cover with <b>exposed support brackets</b> on the outer back.													

DESCRIPTION	MODEL#	STANDARD FABRIC GRADES											
		COM	2	3	4	5	6	7	8	9	10	11	12
 <p><b>HB Bariatric Stacking Armchair, 4 Leg Base</b> COM Yardage: 2.75 Freight Class: 300 Product Weight (lbs.): 47 Cubic Feet Per Carton: 22.5</p>	<b>GC6920HB</b>	\$1302	\$1396	\$1476	\$1593	\$1758	\$1834	\$1984	\$2221	\$2406	\$2609	\$3029	\$3476
		OVERALL DIMENSIONS			SEAT DIMENSIONS			BACK DIMENSIONS					
		W	D	H	W	D	H	W	H				
		36.5	26	38.5	30	18	17.5	30	21				
		Active weight 500 lbs. Single piece back with pullover style upholstery cover with <b>exposed support brackets</b> on the outer back.											
 <p><b>LB Bariatric Armchair, Sled Base</b> COM Yardage: 2.5 Freight Class: 250 Product Weight (lbs.): 48 Cubic Feet Per Carton: 20.5</p>	<b>GC6921</b>	\$1487	\$1572	\$1644	\$1750	\$1898	\$1967	\$2101	\$2316	\$2482	\$2666	\$3044	\$3449
		OVERALL DIMENSIONS			SEAT DIMENSIONS			BACK DIMENSIONS					
		W	D	H	W	D	H	W	H				
		36.5	26	33	30	18	17.5	30	15.5				
		Active weight 500 lbs. Single piece back with pullover style upholstery cover with <b>exposed support brackets</b> on the outer back. <b>Does not stack.</b>											
 <p><b>HB Bariatric Armchair, Sled Base</b> COM Yardage: 3 Freight Class: 300 Product Weight (lbs.): 51 Cubic Feet Per Carton: 22.5</p>	<b>GC6921HB</b>	\$1472	\$1570	\$1651	\$1771	\$1941	\$2021	\$2175	\$2421	\$2609	\$2820	\$3253	\$3715
		OVERALL DIMENSIONS			SEAT DIMENSIONS			BACK DIMENSIONS					
		W	D	H	W	D	H	W	H				
		36.5	26	38.5	30	18	17.5	30	21				
		Active weight 500 lbs. Single piece back with pullover style upholstery cover with <b>exposed support brackets</b> on the outer back. <b>Does not stack.</b>											
 <p><b>LB Bariatric Stacking Armchair, Sled Base with concealed attachment</b> COM Yardage: 2.5 Freight Class: 250 Product Weight (lbs.): 48 Cubic Feet Per Carton: 20.5</p>	<b>GC6922</b>	\$1487	\$1572	\$1644	\$1750	\$1898	\$1967	\$2101	\$2316	\$2482	\$2666	\$3044	\$3449
		OVERALL DIMENSIONS			SEAT DIMENSIONS			BACK DIMENSIONS					
		W	D	H	W	D	H	W	H				
		36.5	26	33	30	18	17.5	30	15.5				
		Active weight 500 lbs.											
 <p><b>HB Bariatric Stacking Armchair, Sled Base with concealed attachment</b> COM Yardage: 3 Freight Class: 300 Product Weight (lbs.): 51 Cubic Feet Per Carton: 22.5</p>	<b>GC6922HB</b>	\$1472	\$1570	\$1651	\$1771	\$1941	\$2021	\$2175	\$2421	\$2609	\$2820	\$3253	\$3715
		OVERALL DIMENSIONS			SEAT DIMENSIONS			BACK DIMENSIONS					
		W	D	H	W	D	H	W	H				
		36.5	26	38.5	30	18	17.5	30	21				
		Active weight 500 lbs.											

DESCRIPTION	MODEL#	STANDARD FABRIC GRADES											
		COM	2	3	4	5	6	7	8	9	10	11	12
 <b>LB Bariatric Stacking Armchair, 4 Leg Base</b> with concealed attachment COM Yardage: 2.5 Freight Class: 250 Product Weight (lbs.): 46 Cubic Feet Per Carton: 20.5 Active weight 500 lbs.	<b>GC6923</b>	\$1241	\$1326	\$1396	\$1501	\$1651	\$1721	\$1855	\$2070	\$2235	\$2418	\$2798	\$3202
	<b>OVERALL DIMENSIONS</b>			<b>SEAT DIMENSIONS</b>			<b>BACK DIMENSIONS</b>						
	<b>W</b>	<b>D</b>	<b>H</b>	<b>W</b>	<b>D</b>	<b>H</b>	<b>W</b>	<b>H</b>					
	36.5	26	33	30	18	17.5	30	15.5					
 <b>HB Bariatric Stacking Armchair, 4 Leg Base</b> with concealed attachment COM Yardage: 3 Freight Class: 250 Product Weight (lbs.): 47 Cubic Feet Per Carton: 22.5 Active weight 500 lbs.	<b>GC6923HB</b>	\$1302	\$1396	\$1476	\$1593	\$1758	\$1834	\$1984	\$2221	\$2406	\$2609	\$3029	\$3476
	<b>OVERALL DIMENSIONS</b>			<b>SEAT DIMENSIONS</b>			<b>BACK DIMENSIONS</b>						
	<b>W</b>	<b>D</b>	<b>H</b>	<b>W</b>	<b>D</b>	<b>H</b>	<b>W</b>	<b>H</b>					
	36.5	26	38.5	30	18	17.5	30	21					
 <b>LB Midsize Stacking Armchair, 4 Leg Base</b> with concealed attachment COM Yardage: 2.5 Freight Class: 250 Product Weight (lbs.): 34 Cubic Feet Per Carton: 16 Active weight 500 lbs.	<b>GC6924</b>	\$908	\$993	\$1065	\$1173	\$1319	\$1389	\$1525	\$1738	\$1902	\$2087	\$2465	\$2870
	<b>OVERALL DIMENSIONS</b>			<b>SEAT DIMENSIONS</b>			<b>BACK DIMENSIONS</b>						
	<b>W</b>	<b>D</b>	<b>H</b>	<b>W</b>	<b>D</b>	<b>H</b>	<b>W</b>	<b>H</b>					
	30.5	24	33	24	18	17.5	24	15.5					
 <b>HB Midsize Stacking Armchair, 4 Leg Base</b> with concealed attachment COM Yardage: 2.75 Freight Class: 250 Product Weight (lbs.): 38 Cubic Feet Per Carton: 18.25 Active weight 500 lbs.	<b>GC6924HB</b>	\$1043	\$1136	\$1213	\$1328	\$1493	\$1571	\$1718	\$1953	\$2136	\$2337	\$2754	\$3197
	<b>OVERALL DIMENSIONS</b>			<b>SEAT DIMENSIONS</b>			<b>BACK DIMENSIONS</b>						
	<b>W</b>	<b>D</b>	<b>H</b>	<b>W</b>	<b>D</b>	<b>H</b>	<b>W</b>	<b>H</b>					
	30.5	24	38.5	24	18	17.5	24	21					
 <b>LB Midsize Stacking Chair, 4 Leg Base</b> with concealed attachment COM Yardage: 2.5 Freight Class: 250 Product Weight (lbs.): 30 Cubic Feet Per Carton: 14.5 Active weight 500 lbs.	<b>GC6925</b>	\$870	\$955	\$1025	\$1133	\$1280	\$1350	\$1484	\$1700	\$1865	\$2048	\$2427	\$2831
	<b>OVERALL DIMENSIONS</b>			<b>SEAT DIMENSIONS</b>			<b>BACK DIMENSIONS</b>						
	<b>W</b>	<b>D</b>	<b>H</b>	<b>W</b>	<b>D</b>	<b>H</b>	<b>W</b>	<b>H</b>					
	26	24	33	24	18	17.5	24	15.5					

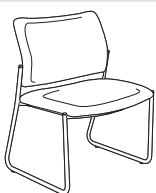

DESCRIPTION	MODEL#	STANDARD FABRIC GRADES											
		COM	2	3	4	5	6	7	8	9	10	11	12
 <p><b>HB Midsize Stacking Chair, 4 Leg Base</b> with concealed attachment COM Yardage: 2.75 Freight Class: 300 Product Weight (lbs.): 33 Cubic Feet Per Carton: 17.75</p>	<b>GC6925HB</b>	<b>\$1004</b>	<b>\$1096</b>	<b>\$1173</b>	<b>\$1288</b>	<b>\$1454</b>	<b>\$1531</b>	<b>\$1678</b>	<b>\$1915</b>	<b>\$2097</b>	<b>\$2300</b>	<b>\$2715</b>	<b>\$3157</b>
		<b>OVERALL DIMENSIONS</b>			<b>SEAT DIMENSIONS</b>			<b>BACK DIMENSIONS</b>					
		<b>W</b>	<b>D</b>	<b>H</b>	<b>W</b>	<b>D</b>	<b>H</b>	<b>W</b>	<b>H</b>				
	26	24	38.5	24	18	17.5	24	21					
 <p><b>LB Midsize Armchair, Sled Base</b> with concealed attachment COM Yardage: 2.5 Freight Class: 250 Product Weight (lbs.): 36 Cubic Feet Per Carton: 16</p>	<b>GC6926</b>	<b>\$1128</b>	<b>\$1213</b>	<b>\$1285</b>	<b>\$1391</b>	<b>\$1539</b>	<b>\$1608</b>	<b>\$1745</b>	<b>\$1957</b>	<b>\$2123</b>	<b>\$2307</b>	<b>\$2685</b>	<b>\$3090</b>
		<b>OVERALL DIMENSIONS</b>			<b>SEAT DIMENSIONS</b>			<b>BACK DIMENSIONS</b>					
		<b>W</b>	<b>D</b>	<b>H</b>	<b>W</b>	<b>D</b>	<b>H</b>	<b>W</b>	<b>H</b>				
	30.5	24	33	24	18	17.5	24	15.5					
 <p><b>HB Midsize Armchair, Sled Base</b> with concealed attachment COM Yardage: 2.75 Freight Class: 250 Product Weight (lbs.): 39 Cubic Feet Per Carton: 18.25</p>	<b>GC6926HB</b>	<b>\$1272</b>	<b>\$1366</b>	<b>\$1445</b>	<b>\$1559</b>	<b>\$1724</b>	<b>\$1801</b>	<b>\$1949</b>	<b>\$2185</b>	<b>\$2366</b>	<b>\$2569</b>	<b>\$2985</b>	<b>\$3427</b>
		<b>OVERALL DIMENSIONS</b>			<b>SEAT DIMENSIONS</b>			<b>BACK DIMENSIONS</b>					
		<b>W</b>	<b>D</b>	<b>H</b>	<b>W</b>	<b>D</b>	<b>H</b>	<b>W</b>	<b>H</b>				
	30.5	24	38.5	24	18	17.5	24	21					
 <p><b>LB Midsize Side Chair, Sled Base</b> with concealed attachment COM Yardage: 2.5 Freight Class: 250 Product Weight (lbs.): 34 Cubic Feet Per Carton: 14.5</p>	<b>GC6927</b>	<b>\$1087</b>	<b>\$1172</b>	<b>\$1244</b>	<b>\$1350</b>	<b>\$1498</b>	<b>\$1567</b>	<b>\$1704</b>	<b>\$1918</b>	<b>\$2082</b>	<b>\$2266</b>	<b>\$2645</b>	<b>\$3049</b>
		<b>OVERALL DIMENSIONS</b>			<b>SEAT DIMENSIONS</b>			<b>BACK DIMENSIONS</b>					
		<b>W</b>	<b>D</b>	<b>H</b>	<b>W</b>	<b>D</b>	<b>H</b>	<b>W</b>	<b>H</b>				
	26	24	33	24	18	17.5	24	15.5					
 <p><b>HB Midsize Side Chair, Sled Base</b> with concealed attachment COM Yardage: 2.75 Freight Class: 250 Product Weight (lbs.): 37 Cubic Feet Per Carton: 17.75</p>	<b>GC6927HB</b>	<b>\$1234</b>	<b>\$1327</b>	<b>\$1406</b>	<b>\$1519</b>	<b>\$1684</b>	<b>\$1762</b>	<b>\$1909</b>	<b>\$2145</b>	<b>\$2327</b>	<b>\$2530</b>	<b>\$2945</b>	<b>\$3389</b>
		<b>OVERALL DIMENSIONS</b>			<b>SEAT DIMENSIONS</b>			<b>BACK DIMENSIONS</b>					
		<b>W</b>	<b>D</b>	<b>H</b>	<b>W</b>	<b>D</b>	<b>H</b>	<b>W</b>	<b>H</b>				
	26	24	38.5	24	18	17.5	24	21					

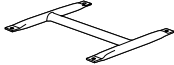
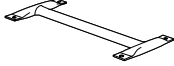
DESCRIPTION	MODEL#	STANDARD FABRIC GRADES							
	GC6928	LIST PRICE							
		\$104							
		OVERALL DIMENSIONS			SEAT DIMENSIONS			BACK DIMENSIONS	
<b>Metal Ganging Connector for Armchairs</b> Freight Class: 92.5 Product Weight (lbs.): 4 Cubic Feet Per Carton: 0.4		W	D	H	W	D	H	W	H
		12	13.75	1					
	GC6929	LIST PRICE							
		\$104							
		OVERALL DIMENSIONS			SEAT DIMENSIONS			BACK DIMENSIONS	
<b>Metal Ganging Connector for Armless Chairs</b> Freight Class: 100 Product Weight (lbs.): 3.5 Cubic Feet Per Carton: 0.4		W	D	H	W	D	H	W	H
		7.87	13.75	1					

GC SIRENA™



model GC3380



model GC3380RTL/M

STANDARD FEATURES

- The size and scale of this chair permits it to be used in smaller areas, where space is a consideration and style cannot be compromised. The soft curves and comfortable fit make this the right solution for creating group seating areas or in confined spaces.
- Complementary round foot design is available in Black only.
- For tablet models, please specify left hand or right hand tablet at time of order (determined from the seated position). See models below.
- Tablets rotate and are non-removable. Overall tablet size is 17"W by 14"D.
- Laminate tablet surfaces are 1.5" thick.
- (C1M) dual wheel carpet casters are standard on select models.
- The interior wood frame is an interlocking construction providing superior strength and long-term durability.
- Cleanout space is provided around the seat pan for easy housekeeping and infection prevention practices
- Seat cushion can be removed should replacement be required
- For added comfort, seats are standard with high density Ultracell bio foam.
- For Globalcare Cryton and Vinyl options, visit the website at [globalfurnituregroup.com](http://globalfurnituregroup.com).
- Can be upholstered in standard Global textiles if healthcare compliance is not required.

OPTIONAL FEATURES

- Laminate finishes: Absolute Acajou (ACJ), Asian Night (ASN), Avant Cherry (AWC), Avant Honey (AWH), Black (BLK), Brushed Cobalt (BRC), Clear Maple (CMB), Dark Espresso (DES), Designer White (DWT), Hayden Grey (HGT), Noce Biondo (NBM), Noce Leggero (NEM), Noce Grigio (NGM), Noce Medio (NMM), Quartered Mahogany (QTM), Tiger Fruitwood (TFW), Tiger Walnut (TWL), Walnut Heights (WHE), White Chocolate (WHC) and Winter Cherry (WCR). Please specify
- To add sealed seams to your product, contact CustomerCare for more information.
- For moisture barrier on seat, please specify (MB). Add \$156.

SUGGESTED APPLICATIONS

- Dining/Cafeteria
- Guest seating
- Lobbies
- Lounge/Waiting
- Office/Meeting
- Patient rooms
- Resident rooms

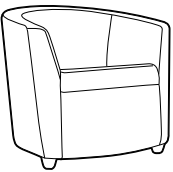
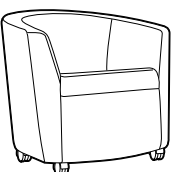
DESCRIPTION	MODEL# / FEATURES	STANDARD TEXTILE GRADES											
		COM	2	3	4	5	6	7	8	9	10	11	12
 <p><b>Club Chair w/Seat Clean Out</b> COM Yardage: 4.25 Freight Class: 250 Product Weight (lbs.): 52 Cubic Feet Per Carton: 19.25</p>	GC3380	\$1579	\$1713	\$1826	\$1989	\$2223	\$2333	\$2542	\$2879	\$3139	\$3430	\$4022	\$4654
		OVERALL DIMENSIONS			SEAT DIMENSIONS			BACK DIMENSIONS					
		W	D	H	W	D	H	W	H				
		30.5	29.5	28.5	20	20	17.5	19	11.5				
 <p><b>Club Chair on Casters w/Seat Clean Out</b> COM Yardage: 4.25 Freight Class: 250 Product Weight (lbs.): 52 Cubic Feet Per Carton: 19.25</p>	GC3380C	\$1590	\$1724	\$1834	\$1997	\$2227	\$2337	\$2546	\$2879	\$3136	\$3423	\$4009	\$4637
		OVERALL DIMENSIONS			SEAT DIMENSIONS			BACK DIMENSIONS					
		W	D	H	W	D	H	W	H				
		30.5	29.5	29.5	20	20	18	19	12.5				

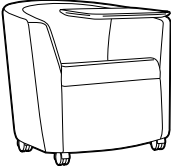
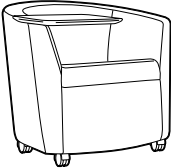
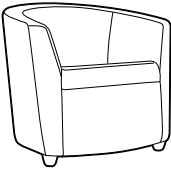
DESCRIPTION	MODEL#	STANDARD FABRIC GRADES											
		COM	2	3	4	5	6	7	8	9	10	11	12
 <p><b>Club Chair on Casters w/Seat Clean Out and LP Tablet - Left</b>                      COM Yardage: 4.25                      Freight Class: 250                      Product Weight (lbs.): 62                      Cubic Feet Per Carton: 19.25</p>	GC3380CLTL	\$2085	\$2219	\$2329	\$2492	\$2722	\$2832	\$3042	\$3374	\$3631	\$3918	\$4504	\$5133
		OVERALL DIMENSIONS			SEAT DIMENSIONS			BACK DIMENSIONS					
		W	D	H	W	D	H	W	H				
		32	29.5	29.5	20	20	18	19	12.5				
 <p><b>Club Chair on Casters w/Seat Clean Out and LP Tablet - Right</b>                      COM Yardage: 4.25                      Freight Class: 250                      Product Weight (lbs.): 62                      Cubic Feet Per Carton: 19.25</p>	GC3380CRTL	\$2085	\$2219	\$2329	\$2492	\$2722	\$2832	\$3042	\$3374	\$3631	\$3918	\$4504	\$5133
		OVERALL DIMENSIONS			SEAT DIMENSIONS			BACK DIMENSIONS					
		W	D	H	W	D	H	W	H				
		32	29.5	29.5	20	20	18	19	12.5				
 <p><b>Weighted Club Chair w/Seat Clean Out</b>                      COM Yardage: 4.25                      Freight Class: 150                      Product Weight (lbs.): 108                      Cubic Feet Per Carton: 19.25</p>	GC3380-CW	\$1764	\$1897	\$2008	\$2171	\$2401	\$2511	\$2719	\$3053	\$3310	\$3597	\$4184	\$4811
		OVERALL DIMENSIONS			SEAT DIMENSIONS			BACK DIMENSIONS					
		W	D	H	W	D	H	W	H				
		30.5	29.5	28.5	20	20	17.5	19	11.5				

GC VION



model GC6322-4 (BLK-C)

STANDARD FEATURES

- GC Vion is a comprehensive seating series offering a family of models to address multiple applications: task, management and conference.
- Series offers mid and high back models with either a mesh or upholstered back.
- Mechanism options available: synchro tilter (-0) and tilter (-4).
- All models are standard with height and width adjustable arms (AS) that feature a front to back sliding armcap.
- Standard with Global's high quality Soft Descent™ pneumatic lift which slowly and gently lowers the seat height of the chair, making it easy to obtain the desired position.
- Side activated sliding seat depth adjustment (MD) is standard on synchro-tilter with back angle adjustment.
- Standard with Black five prong, injection molded, fiberglass reinforced nylon Governor base (B7) with dual wheel carpet casters (C1).
- Mesh back models are available in 10 colors: Aqua (MS75), Black (MS69), Black Cherry (MS76), Blue (MS72), Dust (MS77), Ivory (MS78), Natural (MS74), Paprika (MS79), Rope (MS73) and Stone (MS71).

OPTIONAL FEATURES

- Petite seat models (2" shorter and 2" narrower than the standard size seat) are available. Specify (ST) for standard seat or (P) for petite seat. No upcharge.
- An optional moisture barrier is available for the seat cushion. Specify (NB) for no moisture barrier, no upcharge, or (MB) for Moisture Barrier. Add \$108.
- Sealed seams are available on the seat of GC Vion models when specified with approved coated textile. Contact Customer Care for availability. Specify (NS) for no sealed seams, no upcharge, or (SE) for sealed seat seams. Add \$24.
- For hard surface flooring casters, please specify (C9R). Add \$62.
- Two featured "T" arm options that include height and width adjusting arms, one with sliding arm caps (AS) and one without sliding arm caps (AF). Also, available is a stylish fixed urethane arm (C) for conference/management environments.
- For additional arm/caster options, please refer to the Arm and Caster section of the Seating List Price Book. *Optional casters may be priced higher than the standard casters for your chair and the difference will be charged. Lower priced optional casters will not be credited.*

- Underside of the seat is upholstered in a coated textile. The joining of the textiles on the underside of the seat pan is sealed on all models.
- Upholstered back models feature black fabric Jenny (JN02) on the back side as standard.
- Upholstery options: fabric, vinyl or leather. Not available in leather/mock leather combination or Crescent fabric.

GC VION FINISHES - TASK SEATING				
Back Frame	Base	Specify Code	Arm Option	Specify Code
Black	Black	BK	Adj: "T" arm (Black) Adj: "T" arm, fixed armcap (Black) Adj: "T" arm (Black, Chrome accent) Adj: "T" arm, fixed armcap (Black, Chrome accent)	AS AF AC AD
Black	Polished Aluminum	BA Add \$145	Adj: "T" arm (Fog) Adj: "T" arm, fixed armcap (Fog) Adj: "T" arm (Fog, Chrome accent) Adj: "T" arm, fixed armcap (Fog, Chrome accent)	FA FF FC CF
Fog	Fog	FG Add \$70	Fixed "C" arm (Black) Fixed "C" arm (Fog) Fixed "C" arm (Polished Aluminum)	C CC CA - Add \$176

\* All arms have Black SSU Armcaps.

MECHANISMS:

Synchro-tilter mechanism (-0)

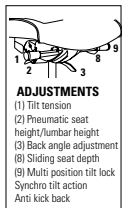

Ergonomic features:  
A, B, C, E, G, H, L, M, N, O, U

Tilter (-4)

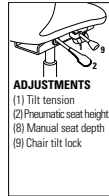





Ergonomic features:  
A, B, C, E, H, M, N, O, S, U

EXAMPLE GC VION ORDER CODE:

GC3622-0	-BA	-MS76	-ST	-ST	-HX01
Model #	Finish	Mesh	Seat size	Seat foam	Seat upholstery

-AF	-EE	-MB	-NS	-5L
Arms	Casters	Moisture barrier	Sealed seams	Pneumatic lift

DESCRIPTION	MODEL#	STANDARD FABRIC GRADES											
		COM	2	3	4	5	6	7	8	9	10	11	12
 <p><b>MB Synchro-Tilter w/Back Angle Adj.</b>, mesh back COM Yardage: 1 Freight Class: 150 Product Weight (lbs.): 58 Cubic Feet Per Carton: 10.5</p>	GC6322-0	\$1207	\$1233	1257	1292	1339	1361	\$1405	\$1475	\$1527	1588	1709	1840
		OVERALL DIMENSIONS			SEAT DIMENSIONS			BACK DIMENSIONS					
		W	D	H	W	D	H	W	H				
		25.5	24	39.5	20	17-20	17.5-22.5	18.5	21				
 <p><b>MB Tilter</b>, mesh back COM Yardage: 1 Freight Class: 150 Product Weight (lbs.): 52 Cubic Feet Per Carton: 10.5</p>	GC6322-4	\$1074	\$1100	1127	1163	1214	1237	\$1284	\$1358	\$1415	\$1478	\$1607	\$1747
		OVERALL DIMENSIONS			SEAT DIMENSIONS			BACK DIMENSIONS					
		W	D	H	W	D	H	W	H				
		25.5	24	37.5	20	17.5	16-21	18.5	21				
 <p><b>HB Synchro-Tilter w/Back Angle Adj.</b>, upholstered back, standard seat COM Yardage: 1.25 Freight Class: 150 Product Weight (lbs.): 61 Cubic Feet Per Carton: 10.5</p>	GC6331-0	\$1252	\$1285	\$1315	\$1357	\$1417	\$1446	\$1500	\$1587	\$1653	\$1728	\$1881	\$2044
		OVERALL DIMENSIONS			SEAT DIMENSIONS			BACK DIMENSIONS					
		W	D	H	W	D	H	W	H				
		25.5	24	41.5	20	17-20	17.5-22.5	18.5	23				
 <p><b>HB Tilter</b>, upholstered back, standard seat COM Yardage: 1.25 Freight Class: 150 Product Weight (lbs.): 55 Cubic Feet Per Carton: 10.5</p>	GC6331-4	\$1089	\$1123	\$1154	\$1197	\$1259	\$1288	\$1344	\$1433	\$1503	\$1579	\$1736	\$1905
		OVERALL DIMENSIONS			SEAT DIMENSIONS			BACK DIMENSIONS					
		W	D	H	W	D	H	W	H				
		25.5	24	39.25	20	17.5	16-21	18.5	23				

GC-WIND



Removable Seat Cushion Tubular Steel Leg

model 3361HB



model 3363HB

STANDARD FEATURES

- An attractive, sleek and modern lounge series on Chrome tubular legs.
- Seat cushions are easily removable for cleaning and the open frame is great for housekeeping access. Cushion covers are removable.
- For added comfort, seats are standard with high density Ultracell bio foam.
- Base is available in Chrome, Black (BLK), Charcoal (CHR), Shadow (SHW), Toast (TOA), Tungsten (TUN), Latte (LAB), Mocha (JS2), and Kalua (KAL) are also available.
- Standard glide is plastic.
- For Globalcare textiles and finish options, visit the website at www.globalfurnituregroup.com
- This product can be upholstered in standard Global textiles only if Healthcare compliance is not required.
- Shipped fully assembled

OPTIONAL FEATURES

- For hard surface floors, please specify opaque non-marking glides (NM). No upcharge.
- To add sealed seams to your product contact Customer Care. Upcharges vary
- Moisture Barrier (Seat Only) - **Add \$178** list upcharge for Lounge Chair. For 2 seat sofa - **Add \$353** list upcharge and for 3 seat sofa - **Add \$524**.

SUGGESTED APPLICATIONS

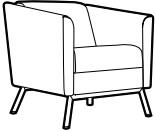
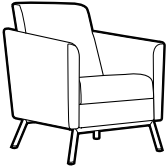
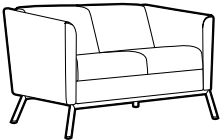

- Lobbies
- Lounge / Waiting
- Office / Meeting
- Patient rooms
- Resident rooms

DESCRIPTION	MODEL#	STANDARD FABRIC GRADES											
		COM	2	3	4	5	6	7	8	9	10	11	12
 <p><b>Lounge Chair</b> COM Yardage: 4.25 Freight Class: 250 Product Weight (lbs.): 62 Cubic Feet Per Carton: 16.5</p>	GC3361	\$2338	\$2501	\$2636	\$2834	\$3116	\$3248	\$3504	\$3910	\$4227	\$4576	\$5295	\$6062
		<b>OVERALL DIMENSIONS</b>			<b>SEAT DIMENSIONS</b>			<b>BACK DIMENSIONS</b>					
		W	D	H	W	D	H	W	H				
Active weight 300 lbs. Removable seat cushion.		27.5	29	28.5	19.5	19	17	19	12				
 <p><b>High Back Lounge Chair</b> COM Yardage: 4.75 Freight Class: 250 Product Weight (lbs.): 69 Cubic Feet Per Carton: 23</p>	GC3361HB	\$2123	\$2286	\$2421	\$2620	\$2901	\$3033	\$3289	\$3698	\$4012	\$4361	\$5082	\$5847
		<b>OVERALL DIMENSIONS</b>			<b>SEAT DIMENSIONS</b>			<b>BACK DIMENSIONS</b>					
		W	D	H	W	D	H	W	H				
Active weight 300 lbs. Removable seat cushion.		27.5	29	36	19.5	19	17	19	19.5				
 <p><b>Two Seat Sofa</b> COM Yardage: 7.25 Freight Class: 250 Product Weight (lbs.): 102 Cubic Feet Per Carton: 30</p>	GC3362	\$2869	\$3115	\$3317	\$3618	\$4043	\$4243	\$4629	\$5245	\$5719	\$6246	\$7330	\$8489
		<b>OVERALL DIMENSIONS</b>			<b>SEAT DIMENSIONS</b>			<b>BACK DIMENSIONS</b>					
		W	D	H	W	D	H	W	H				
Active weight 300 lbs./seat Removable seat cushion.		54.5	29	28.5	46.5	19	17	46.5	12				

# SEATING

GC WIND™

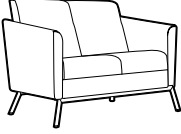
G

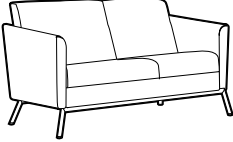
DESCRIPTION	MODEL#	STANDARD FABRIC GRADES											
		COM	2	3	4	5	6	7	8	9	10	11	12
 <p><b>High Back Two Seat Sofa</b> COM Yardage: 8 Freight Class: 250 Product Weight (lbs.): 107 Cubic Feet Per Carton: 44.75</p>	GC3362HB	\$2962	\$3203	\$3566	\$3872	\$4306	\$4473	\$4854	\$5573	\$5930	\$6597	\$7524	\$8670
		OVERALL DIMENSIONS			SEAT DIMENSIONS			BACK DIMENSIONS					
		W	D	H	W	D	H	W	H				
		54.5	29	36	46.5	19	17	46.5	19.5				
Active weight 300 lbs./seat	Removable seat cushion.												
 <p><b>Three Seat Sofa</b> COM Yardage: 10.5 Freight Class: 250 Product Weight (lbs.): 135 Cubic Feet Per Carton: 42.5</p>	GC3363	\$3593	\$3952	\$4244	\$4679	\$5296	\$5586	\$6145	\$7035	\$7720	\$8484	\$10055	\$11732
		OVERALL DIMENSIONS			SEAT DIMENSIONS			BACK DIMENSIONS					
		W	D	H	W	D	H	W	H				
		78	29	28.5	70.5	19	17	70.5	12				
Active weight 300 lbs./seat	Removable seat cushion.												
 <p><b>High Back Three Seat Sofa</b> COM Yardage: 12.25 Freight Class: 250 Product Weight (lbs.): 140 Cubic Feet Per Carton: 62.25</p>	GC3363HB	\$3691	\$4062	\$4574	\$5046	\$5713	\$5964	\$6546	\$7645	\$8199	\$9218	\$10638	\$12389
		OVERALL DIMENSIONS			SEAT DIMENSIONS			BACK DIMENSIONS					
		W	D	H	W	D	H	W	H				
		78	29	36	70.5	19	17	70.5	19.5				
Active weight 300 lbs./seat	Removable seat cushion.												



JANNA



model GC7609

STANDARD FEATURES



- Very often tight spaces create a challenge when additional seating is required for guests. Janna's unique folding frame is the perfect solution for temporary seating, especially where space is at a premium.
- Molded wood veneer frame.
- Concealed folding mechanism uses metal-to-metal construction details with lock tight fasteners.
- For added comfort, seats are standard with high density foam.
- Non-marking nylon glides are standard.
- For Globalcare textiles, visit the website at globalfurnituregroup.com.
- Can be upholstered in standard Global textiles if Healthcare compliance is not required
- Shipped fully assembled.

OPTIONAL FEATURES

- Wood frame available in Absolute (AAM), Black (BKM), Cherry (ACM), English Oak (EOM), Espresso Cafe (ECM), Fruitwood (TFM), Gray (HGM), Honey (AHM), Mahogany (TMM), Maple (AVM), Medium Walnut (MWM), Natural Walnut (NLW), Night (ASM), Noce Biondo (NBM), Noce Grigio (NGM), Noce Leggero (NEM), Noce Medio (NMM), Sandy Beach (SKM), Shaker Cherry (SKM), Silver Oak (SOM), Walnut (TWM), WC Cream (WTM), White (WHM) and Winter Cherry (WCM). Please specify.
- Optional cushion glide is available - **Add \$15** list upcharge.
- Optional wall bracket (model GC7607) allows chairs to be conveniently stored while not in use. (Underside of chair seat is predrilled to accept wall bracket.)
- For moisture barrier (seat only), **Add \$119** list upcharge.

SUGGESTED APPLICATIONS

- Dining/Cafeteria
- Guest seating
- Lounge/Waiting
- Office/Meeting
- Patient rooms
- Resident rooms
- Treatment/Exam

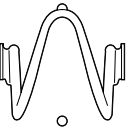
DESCRIPTION	MODEL#	STANDARD FABRIC GRADES											
		COM	2	3	4	5	6	7	8	9	10	11	12
 <p><b>Folding Chair</b> Upholstered Back COM Yardage: 1 Freight Class: 150 Product Weight (lbs.): 19 Cubic Feet Per Carton: 3.5</p>	GC7609	\$646	\$676	\$704	\$743	\$796	\$819	\$866	\$956	\$1001	\$1086	\$1201	\$1344
		OVERALL DIMENSIONS			SEAT DIMENSIONS			BACK DIMENSIONS					
		W	D	H	W	D	H	W	H				
		19	22.5	32.5	16	17.5	18.5	16	13.5				
 <p><b>Folding Chair</b> Wood Back COM Yardage: 1 Freight Class: 150 Product Weight (lbs.): 19 Cubic Feet Per Carton: 3.5</p>	GC7611	\$734	\$765	\$793	\$832	\$885	\$906	\$955	\$1045	\$1090	\$1175	\$1289	\$1433
		OVERALL DIMENSIONS			SEAT DIMENSIONS			BACK DIMENSIONS					
		W	D	H	W	D	H	W	H				
		19	22.5	32.5	16	17.5	18.5	16	13.5				
 <p><b>Wall Mounting Bracket.</b> For Janna series only. Allows for hanging a chair on the wall or behind a door. COM Yardage: -- Freight Class: 70 Product Weight (lbs.): 1.5 Cubic Feet Per Carton: 0.1</p>	GC7607	List Price											
		\$60											
		OVERALL DIMENSIONS			SEAT DIMENSIONS			BACK DIMENSIONS					
		W	D	H	W	D	H	W	H				
			3	1.5	3.5								

**If ordering after the original purchase, specify GC7607.**  
**For complete set at time of order - specify WH. Add \$61**  
 Two (one pair) per package in chrome finish. One bracket connects to the underside of the chair seat. The second bracket connects to the wall or door.

NOURISH



model GC3683F



model GC3685



Headrest adjustment handle



Casters and height adjustable legs



Transfer arm

STANDARD FEATURES

- Nourish is an innovative state of the art patient chair, developed in consultation with leading healthcare professionals. It embraces the body, cultivating comfort during periods of recovery. Housekeeping and infection prevention control will appreciate the hassle-free maintenance and clean design.
- All chair models have a pair of **transfer arms** that are very easy to operate. Transfer arms provide easy access for less mobile users who need transfer to or from a wheelchair, while substantially fostering caregiver safety when patient assistance is required.
- Height adjustable legs** are standard on all models (except Bariatric chair, ottoman and GC3698 - 4 caster model). Legs can be conveniently adapted to provide patients with a seat height range of 17" to 20" for maximum fit. Additional models (-20) provide a seat height range of 20" to 23" ensuring the perfect seating solution is available for multiple applications. Front and back legs can be adjusted separately allowing modification of seat pitch, forward or rearward.
- Models with **rear casters** allow for 'tip and move' so the chair can be conveniently and easily repositioned without lifting.
- Select models have a unique **depth adjustable headrest** solution integrated into the upper back area, preventing any possible loss or misplacement of the headrest. This also makes cleaning and disinfecting easy. The Schukra depth adjustment is placed under the upholstery in the neck region. The depth is controlled by a handle on the lower outer back cushion. The ability to set the intensity of the headrest promotes a healthier, more personal level of comfort during the convalescence period.
- Schukra Depth adjustable lumbar support** for additional comfort is standard on selected models.
- Flex Back models feature a torsion control mechanism, which allows the back to move in a soothing rocking motion.



- For added comfort, seats are standard with high density foam.
- Metal frame is available in Black (BLK), Latte (LAB), Kalua (KAL), Mocha (J52), Shadow (SHW), Toast (TOA) and Tungsten (TUN). Please specify.
- Self-skinned urethane (SSU) armcaps are available in Black (BLK), Latte (LAB), Kalua (KAL), Mocha (J52), Shadow (SHW) and Toast (TOA). Please specify.
- Arm body is only available in Tungsten.
- Active weight capacity for standard single seat is 350 lbs. and 750 lbs for bariatric seating.
- For textile and finish options, visit the website at [www.globalfurnituregroup.com](http://www.globalfurnituregroup.com).
- Can be upholstered in standard Global textiles if Healthcare compliance is not required.

OPTIONAL FEATURES

- Easy grip push bar** is optional on Nourish patient chairs to assist in ease of movement of the chair. Available for all height adjustable leg models in Toast (TOA), Shadow (SHW), Tungsten (TUN) and Black (BLK). Please specify. Add \$138.
- As an option, seams can be sealed to prevent penetration of fluids through the stitching. For high back models, add \$66. For bariatric models, add \$155. For ottoman, add \$30. Contact Customer Care for approved textiles.
- For moisture barrier (seat only), add \$119 per seat. For Bariatric models, add \$170 per seat.

SUGGESTED APPLICATIONS

- Bariatric seating (some models)
- Lounge/Waiting
- Patient rooms
- Resident rooms
- Treatment/Exam rooms

DESCRIPTION	MODEL#	STANDARD FABRIC GRADES																																														
		COM	2	3	4	5	6	7	8	9	10	11	12																																			
 <p><b>High Back Patient Chair</b> COM Yardage: 2 Freight Class: 300 Product Weight (lbs.): 56 Cubic Feet Per Carton: 33.5</p>	GC3681	\$2577	\$2638	\$2693	\$2770	\$2878	\$2920	\$3014	\$3197	\$3286	\$3454	\$3685	\$3972																																			
	GC3681-20 20" seat height	\$2637	\$2698	\$2751	\$2830	\$2938	\$2980	\$3075	\$3256	\$3345	\$3513	\$3745	\$4031																																			
	Active weight 350 lbs.	<table border="1"> <thead> <tr> <th colspan="3">OVERALL DIMENSIONS</th> <th colspan="3">SEAT DIMENSIONS</th> <th colspan="3">BACK DIMENSIONS</th> </tr> <tr> <th>W</th> <th>D</th> <th>H</th> <th>W</th> <th>D</th> <th>H</th> <th>W</th> <th>H</th> <th></th> </tr> </thead> <tbody> <tr> <td>28.5</td> <td>29</td> <td>45.5</td> <td>20</td> <td>18.5</td> <td>17-20</td> <td>20</td> <td>29</td> <td></td> </tr> <tr> <td>28.5</td> <td>29</td> <td>48.5</td> <td>20</td> <td>18.5</td> <td>20-23</td> <td>20</td> <td>29</td> <td></td> </tr> </tbody> </table>												OVERALL DIMENSIONS			SEAT DIMENSIONS			BACK DIMENSIONS			W	D	H	W	D	H	W	H		28.5	29	45.5	20	18.5	17-20	20	29		28.5	29	48.5	20	18.5	20-23	20	29
OVERALL DIMENSIONS			SEAT DIMENSIONS			BACK DIMENSIONS																																										
W	D	H	W	D	H	W	H																																									
28.5	29	45.5	20	18.5	17-20	20	29																																									
28.5	29	48.5	20	18.5	20-23	20	29																																									
 <p><b>High Back Patient Chair Flex Back</b> COM Yardage: 2 Freight Class: 300 Product Weight (lbs.): 56 Cubic Feet Per Carton: 33.5</p>	GC3681F	\$2905	\$2966	\$3019	\$3098	\$3208	\$3248	\$3344	\$3524	\$3613	\$3782	\$4013	\$4299																																			
	GC3681-20F 20" seat height	\$2965	\$3026	\$3082	\$3157	\$3266	\$3308	\$3403	\$3583	\$3673	\$3841	\$4073	\$4359																																			
	Active weight 350 lbs.	<table border="1"> <thead> <tr> <th colspan="3">OVERALL DIMENSIONS</th> <th colspan="3">SEAT DIMENSIONS</th> <th colspan="3">BACK DIMENSIONS</th> </tr> <tr> <th>W</th> <th>D</th> <th>H</th> <th>W</th> <th>D</th> <th>H</th> <th>W</th> <th>H</th> <th></th> </tr> </thead> <tbody> <tr> <td>0</td> <td>0</td> <td>0</td> <td>20</td> <td>18.5</td> <td>20-20</td> <td>20</td> <td>29</td> <td></td> </tr> <tr> <td>0</td> <td>0</td> <td>0</td> <td>20</td> <td>18.5</td> <td>20-23</td> <td>20</td> <td>29</td> <td></td> </tr> </tbody> </table>												OVERALL DIMENSIONS			SEAT DIMENSIONS			BACK DIMENSIONS			W	D	H	W	D	H	W	H		0	0	0	20	18.5	20-20	20	29		0	0	0	20	18.5	20-23	20	29
OVERALL DIMENSIONS			SEAT DIMENSIONS			BACK DIMENSIONS																																										
W	D	H	W	D	H	W	H																																									
0	0	0	20	18.5	20-20	20	29																																									
0	0	0	20	18.5	20-23	20	29																																									

DESCRIPTION	MODEL# / FEATURES	STANDARD TEXTILE GRADES											
		COM	2	3	4	5	6	7	8	9	10	11	12
	<b>GC3682</b>	\$2730	\$2791	\$2844	\$2922	\$3030	\$3073	\$3167	\$3348	\$3436	\$3605	\$3837	\$4124
	<b>GC3682-20</b> 20" seat height	\$2791	\$2851	\$2906	\$2983	\$3091	\$3135	\$3229	\$3409	\$3499	\$3666	\$3899	\$4185
		<b>OVERALL DIMENSIONS</b>			<b>SEAT DIMENSIONS</b>			<b>BACK DIMENSIONS</b>					
		<b>W</b>	<b>D</b>	<b>H</b>	<b>W</b>	<b>D</b>	<b>H</b>	<b>W</b>	<b>H</b>				
		28.5	29	45.5	20	18.5	17-20	20	29				
		28.5	29	48.5	20	18.5	20-23	20	29				
<b>High Back Patient Chair with Schukra depth adjustable lumbar</b> COM Yardage: 2 Freight Class: 300 Product Weight (lbs.): 56 Cubic Feet Per Carton: 33.5		Active weight 350 lbs.											

	<b>GC3682F</b>	\$3060	\$3121	\$3174	\$3252	\$3360	\$3403	\$3498	\$3678	\$3768	\$3935	\$4168	\$4454
	<b>GC3682-20F</b> 20" seat height	\$3119	\$3181	\$3234	\$3313	\$3419	\$3461	\$3556	\$3738	\$3828	\$3996	\$4227	\$4513
		<b>OVERALL DIMENSIONS</b>			<b>SEAT DIMENSIONS</b>			<b>BACK DIMENSIONS</b>					
		<b>W</b>	<b>D</b>	<b>H</b>	<b>W</b>	<b>D</b>	<b>H</b>	<b>W</b>	<b>H</b>				
		0	0	0	20	18.5	20-20	20	29				
		0	0	0	20	18.5	20-23	20	29				
<b>High Back Patient Chair with Schukra depth adjustable lumbar, Flex Back</b> COM Yardage: 2 Freight Class: 300 Product Weight (lbs.): 56 Cubic Feet Per Carton: 33.5		Active weight 350 lbs.											

	<b>GC3683</b>	\$2883	\$2945	\$3000	\$3077	\$3184	\$3225	\$3321	\$3500	\$3592	\$3759	\$3991	\$4276
	<b>GC3683-20</b> 20" seat height	\$2942	\$3004	\$3057	\$3135	\$3243	\$3285	\$3381	\$3562	\$3652	\$3819	\$4050	\$4337
		<b>OVERALL DIMENSIONS</b>			<b>SEAT DIMENSIONS</b>			<b>BACK DIMENSIONS</b>					
		<b>W</b>	<b>D</b>	<b>H</b>	<b>W</b>	<b>D</b>	<b>H</b>	<b>W</b>	<b>H</b>				
		28.5	29	45.5	20	18.5	17-20	20	29				
		28.5	29	48.5	20	18.5	20-23	20	29				
<b>High Back Patient Chair with Schukra depth adjustable headrest</b> COM Yardage: 2 Freight Class: 300 Product Weight (lbs.): 56 Cubic Feet Per Carton: 33.5		Active weight 350 lbs.											

	<b>GC3683F</b>	\$3212	\$3274	\$3327	\$3406	\$3513	\$3555	\$3651	\$3832	\$3922	\$4089	\$4321	\$4607
	<b>GC3683-20F</b> 20" seat height	\$3273	\$3333	\$3389	\$3465	\$3575	\$3617	\$3711	\$3892	\$3981	\$4149	\$4380	\$4667
		<b>OVERALL DIMENSIONS</b>			<b>SEAT DIMENSIONS</b>			<b>BACK DIMENSIONS</b>					
		<b>W</b>	<b>D</b>	<b>H</b>	<b>W</b>	<b>D</b>	<b>H</b>	<b>W</b>	<b>H</b>				
		0	0	0	20	18.5	20-20	20	29				
		28.5	29	0	20	18.5	20-23	20	29				
<b>High Back Patient Chair with Schukra depth adjustable headrest, Flex Back</b> COM Yardage: 2 Freight Class: 300 Product Weight (lbs.): 56 Cubic Feet Per Carton: 33.5		Active weight 350 lbs.											

	<b>GC3684</b>	\$3190	\$3251	\$3306	\$3383	\$3490	\$3533	\$3628	\$3808	\$3898	\$4065	\$4299	\$4584
	<b>GC3684-20</b> 20" seat height	\$3248	\$3308	\$3363	\$3441	\$3548	\$3590	\$3685	\$3867	\$3957	\$4123	\$4355	\$4641
		<b>OVERALL DIMENSIONS</b>			<b>SEAT DIMENSIONS</b>			<b>BACK DIMENSIONS</b>					
		<b>W</b>	<b>D</b>	<b>H</b>	<b>W</b>	<b>D</b>	<b>H</b>	<b>W</b>	<b>H</b>				
		28.5	29	45.5	20	18.5	17-20	20	29				
		28.5	29	48.5	20	18.5	20-23	20	29				
<b>High Back Patient Chair with Schukra depth adjustable lumbar &amp; headrest</b> COM Yardage: 2 Freight Class: 300 Product Weight (lbs.): 56 Cubic Feet Per Carton: 33.5		Active weight 350 lbs.											

DESCRIPTION

MODEL#/FEATURES

STANDARD FABRIC GRADES



	COM	2	3	4	5	6	7	8	9	10	11	12
<b>GC3684F</b>	\$3519	\$3581	\$3632	\$3712	\$3819	\$3861	\$3955	\$4136	\$4228	\$4393	\$4626	\$4912
<b>GC3684-20F</b> 20" seat height	\$3576	\$3638	\$3691	\$3770	\$3878	\$3919	\$4016	\$4196	\$4286	\$4454	\$4685	\$4971

OVERALL DIMENSIONS			SEAT DIMENSIONS			BACK DIMENSIONS	
W	D	H	W	D	H	W	H
0	0	0	20	18.5	20-20	20	29
0	0	0	20	18.5	20-23	20	29

**High Back Patient Chair with Schukra depth adjustable lumbar & headrest, Flex Back**  
 COM Yardage: 2  
 Freight Class: 300  
 Product Weight (lbs.): 56  
 Cubic Feet Per Carton: 33.5  
 Active weight 350 lbs.



	COM	2	3	4	5	6	7	8	9	10	11	12
<b>GC3685</b>	\$3164	\$3267	\$3353	\$3478	\$3657	\$3720	\$3878	\$4168	\$4315	\$4588	\$4965	\$5430

OVERALL DIMENSIONS			SEAT DIMENSIONS			BACK DIMENSIONS	
W	D	H	W	D	H	W	H
40	29	47	35	18.5	18.5	35	29

**Bariatric High Back Patient Chair**  
 COM Yardage: 3.25  
 Freight Class: 300  
 Product Weight (lbs.): 70  
 Cubic Feet Per Carton: 45  
 Active weight 750 lbs.  
 Fixed height legs.



	COM	2	3	4	5	6	7	8	9	10	11	12
<b>GC3686</b>	\$794	\$825	\$851	\$891	\$944	\$966	\$1014	\$1105	\$1148	\$1234	\$1348	\$1492

OVERALL DIMENSIONS			SEAT DIMENSIONS			BACK DIMENSIONS	
W	D	H	W	D	H	W	H
17	17.5	12.5					

**Ottoman**  
 COM Yardage: 1  
 Freight Class: 150  
 Product Weight (lbs.): 18  
 Cubic Feet Per Carton: 3.6  
 Active weight 350 lbs.  
 Can be stored beneath any Nourish chair when not in use.

DESCRIPTION

MODEL#

STANDARD FABRIC GRADES

OTTOMANS



model GC3346

STANDARD FEATURES

- Designed to coordinate with healthcare seating series.
- Seat cushions are easily removable for cleaning.
- Wood legs are available in a variety of finishes.
- A steel leg is optionally available on GC3346. Offered in Black (BLK), Latte (LAB), Toast (TOA), Tungsten (TUN), Shadow (SHW), Mocha (J52), and Kalua (KAL). Please specify.
- For textiles and finish options, visit the website at [www.globalfurnituregroup.com](http://www.globalfurnituregroup.com)
- Standard glide is plastic.
- Shipped fully assembled.

- Can be upholstered in standard Global textiles only if Healthcare compliance is not required.

OPTIONAL FEATURES

- For hardwood legs, non-slip glides specify (NS) - Add \$32 list upcharge.
- For hardwood legs, opaque, non-marking glide is optional for hard surface flooring. No upcharge.

SUGGESTED APPLICATIONS

- Waiting Areas
- Resident Rooms
- Lounges

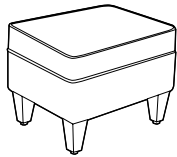

**Ottoman** Block Legs  
COM Yardage: 1.25  
Freight Class: 150  
Product Weight (lbs.): 20  
Cubic Feet Per Carton: 4.6

	COM	2	3	4	5	6	7	8	9	10	11	12
GC3346	\$1347	\$1386	\$1421	\$1469	\$1538	\$1564	\$1623	\$1734	\$1791	\$1896	\$2041	\$2221

OVERALL DIMENSIONS			SEAT DIMENSIONS			BACK DIMENSIONS	
W	D	H	W	D	H	W	H
17.5	19.5	15	--	--	15		

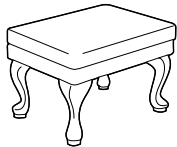

**Ottoman** Queen Anne Legs  
COM Yardage: 1  
Freight Class: 250  
Product Weight (lbs.): 16  
Cubic Feet Per Carton: 5.25

	COM	2	3	4	5	6	7	8	9	10	11	12
GC7536	\$686	\$711	\$775	\$810	\$865	\$884	\$931	\$1018	\$1063	\$1144	\$1258	\$1398

OVERALL DIMENSIONS			SEAT DIMENSIONS			BACK DIMENSIONS	
W	D	H	W	D	H	W	H
21	16	15	--	--	15		

DESCRIPTION MODEL# STANDARD FABRIC GRADES



GC3616W Dining armchair with open arms

Primacare™ set a benchmark for healthcare seating. All the features, all the looks and quite possibly the most extensive offering of its kind for both acute care and long-term care applications.

Under the skin of every Primacare chair is a heart of solid steel waiting to meet the rigorous demands of any environment.

The Primacare series includes more than 40 models that extend from patient rooms to waiting areas, dining rooms to treatment centers including bariatric hip chair solutions.

FEATURES



Open arms



Closed arms - fully upholstered side panels



Arm grip extension - to assist getting in and out of the chair safely

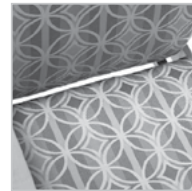

Separate seat and back - provides clean out for housekeeping staff

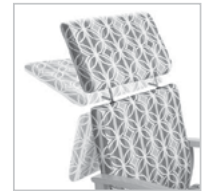

Fold down headrest - to provide access for caregiver assistance

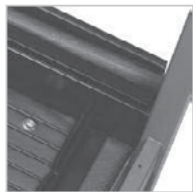

Removable upholstery - for ease of cleaning and replacement

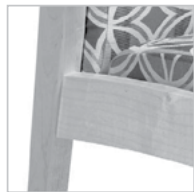

Solid wood frame - in hardwood for long life and a warm look



Metal-to-metal connector - provides unparalleled strength and durability

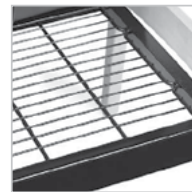

Metal mesh pan - superior comfort and hygiene for patient incontinence



Wall safe legs - offer first contact to protect walls and chair backs on most models

AVAILABLE TEXTILES AND FINISHES

Please see the Globalcare Textile and Finishes section at [www.globalfurnituregroup.com](http://www.globalfurnituregroup.com) for all details including wood finishes.

SUGGESTED APPLICATIONS

- Bariatric seating (some models)
- Dining/Cafeteria
- Guest seating
- Lobbies
- Lounge/Waiting
- Patient rooms
- Resident rooms
- Treatment/Exam rooms

**DINING** - available with wood or metal frames



**GUEST** - available with wood or metal frames



**PATIENT** - available with wood or metal frames



**HIP CHAIRS** - available with wood or metal frames



**LOUNGE** - available with wood or metal legs



**FULLY UPHOLSTERED LOUNGE** - available with wood or metal legs

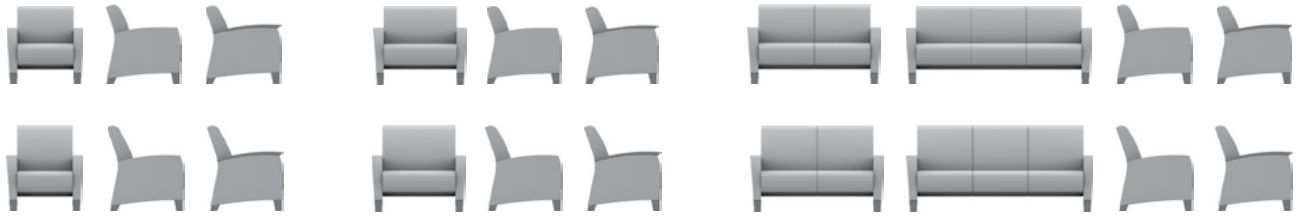

**WINGBACK ARMCHAIR** - available with wood or metal armcaps and legs



**RECLINERS** - available with wood or metal armcaps



**SLEEPERS** - available with wood or metal armcaps



**BENCHES** - available with wood or metal legs



(SSU or wood legs only)

**MODULAR GUEST/PATIENT** - see page 154.



PRIMACARE DINING



model GC3616CA (HT)



model GC3616W (Wood)

STANDARD FEATURES

- Primacare is a family of products offering the most significant return on investment approach in the industry since every component can be repaired or replaced on site.
- **High traffic (HT) models:** Metal frame with die cast zinc connectors and metal-to-metal fasteners. Available in the following finishes: Black (BLK), Latte (LAB), Kalua (KAL), Mocha (J52), Shadow (SHW), Toast (TOA) and Tungsten (TUN).
- **Wood models:** Solid hardwood frame with die cast zinc connectors and metal-to-metal fastening. Available in the following finishes: Absolute (AAM), Charcoal Java (CJM), Cherry (ACM), Empire Mahogany (EMM), English Oak (EOM), Espresso Cafe (ECM), Fruitwood (TFM), Gray (HGM), Harvest Oak (HOM), Honey (AHM), Jet Onyx (JOM), Light Honey (LHM), Mahogany (TMM), Maple (AVM), Medium Walnut (MWM), Natural Walnut (NLW), Night (ASM), Noce Biondo (NBM), Noce Grigio (NGM), Noce Leggero (NEM), Noce Medio (NMM), Sandy Beach (SBM), Shaker Cherry (SKM), Silver Oak (SOM), Walnut (TWM), White (WHM), WC Cream (WTM) and Winter Cherry (WCM).
- Armcaps are securely fastened with metal-to-metal connectors which allow for field replacement if required.
- Easy grip forward extending armcap on models with arms.

- Wood armcaps are standard.
- Replaceable seat covers and replaceable and/or removable seat cushions are standard.
- Waterfall cleanout between the seat and back cushions.
- Models are standard with metal mesh seat deck. For behavioral health applications, the metal mesh seat deck can be covered with a solid moisture resistant surface, held in place with tamperproof fasteners. Contact your Global sales rep for a special quotation.
- All seat frames feature a wall saver design to prevent back contact with wall.
- **GC3616WCA and GC3616CA** have upholstered panel arm inserts closing the arm. (Closed arm panels are designed to be replaceable. Request a special quote to have them secured with tamperproof fasteners.)
- For Globalcare textile options, visit the website at [www.globalfurnituregroup.com](http://www.globalfurnituregroup.com).
- Can be upholstered in standard Global textiles if healthcare compliance is not required.
- It is recommended that High Traffic (HT) models be specified in textiles that meet or exceed 100,000 double rubs for added abrasion performance.
- Shipped fully assembled.
- **HIGH TRAFFIC (HT) MODELS ARE LISTED FIRST, FOLLOWED BY WOOD MODELS.**

OPTIONAL FEATURES

- Self-skinned urethane (SSU) armcaps are available. See far left column "High traffic (HT) models" for finishes. Please specify. *Refer to individual models for availability and pricing.*
- For moisture barrier (seat only), add \$119 list upcharge per seat.
- To add sealed seams to your product contact Customer Care. Upcharges vary.
- For Primacare tables, see page 56.

SUGGESTED APPLICATIONS

- Dining/Cafeteria
- Guest seating
- Lobbies
- Lounge/Waiting
- Patient rooms
- Resident rooms

DESCRIPTION MODEL# / FEATURES STANDARD TEXTILE GRADES



**Dining Chair, Open Arms (HT)**  
COM Yardage: 1.5  
Freight Class: 150  
Product Weight (lbs.): 58  
Cubic Feet Per Carton: 13.25

MODEL# / FEATURES	COM	2	3	4	5	6	7	8	9	10	11	12
<b>GC3616</b> Metal	\$1530	\$1576	\$1617	\$1674	\$1757	\$1786	\$1858	\$1993	\$2061	\$2188	\$2361	\$2576
<b>OVERALL DIMENSIONS</b>			<b>SEAT DIMENSIONS</b>			<b>BACK DIMENSIONS</b>						
	<b>W</b>	<b>D</b>	<b>H</b>	<b>W</b>	<b>D</b>	<b>H</b>	<b>W</b>	<b>H</b>				
	23	23	34.5	19	17.5	18	19	16.5				

Active weight 500 lbs.  
SSU armcap option - **Add \$96 list upcharge**



**Dining Chair, Closed Arms (HT)**  
COM Yardage: 2  
Freight Class: 150  
Product Weight (lbs.): 66  
Cubic Feet Per Carton: 13.25

MODEL# / FEATURES	COM	2	3	4	5	6	7	8	9	10	11	12
<b>GC3616CA</b> Metal	\$1757	\$1819	\$1870	\$1950	\$2057	\$2099	\$2194	\$2376	\$2466	\$2633	\$2864	\$3151
<b>OVERALL DIMENSIONS</b>			<b>SEAT DIMENSIONS</b>			<b>BACK DIMENSIONS</b>						
	<b>W</b>	<b>D</b>	<b>H</b>	<b>W</b>	<b>D</b>	<b>H</b>	<b>W</b>	<b>H</b>				
	23	23	34.5	19	17.5	18	19	16.5				

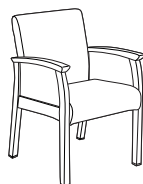

Active weight 500 lbs.  
SSU armcap option - **Add \$96 list upcharge**



**Dining Chair, Closed Arms, Laminate Panels (HT)**  
COM Yardage: 1.5  
Freight Class: 150  
Product Weight (lbs.): 66  
Cubic Feet Per Carton: 13.25

MODEL# / FEATURES	COM	2	3	4	5	6	7	8	9	10	11	12
<b>GC3616CAL</b> Metal	\$2071	\$2112	\$2149	\$2200	\$2275	\$2309	\$2375	\$2480	\$2562	\$2654	\$2842	\$3040
<b>OVERALL DIMENSIONS</b>			<b>SEAT DIMENSIONS</b>			<b>BACK DIMENSIONS</b>						
	<b>W</b>	<b>D</b>	<b>H</b>	<b>W</b>	<b>D</b>	<b>H</b>	<b>W</b>	<b>H</b>				
	23	23	34.5	19	17.5	18	19	16.5				

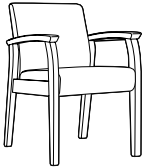
Active weight 500 lbs.  
SSU armcap option - **Add \$96 list upcharge**

DESCRIPTION	MODEL#	STANDARD FABRIC GRADES											
		COM	2	3	4	5	6	7	8	9	10	11	12
 <p><b>Dining Chair, Open Arms (Wood)</b> COM Yardage: 1.5 Freight Class: 250 Product Weight (lbs.): 50 Cubic Feet Per Carton: 13.25</p>	<b>GC3616W</b> Wood	\$1262	\$1306	\$1347	\$1405	\$1488	\$1517	\$1591	\$1724	\$1791	\$1918	\$2093	\$2306
		OVERALL DIMENSIONS			SEAT DIMENSIONS			BACK DIMENSIONS					
		W	D	H	W	D	H	W	H				
		23	23	34.5	19	17.5	18	19	16.5				
Active weight 350 lbs.		SSU armcap option - <b>Add \$96 list upcharge</b>											
 <p><b>Dining Chair, Closed Arms (Wood)</b> COM Yardage: 2 Freight Class: 150 Product Weight (lbs.): 58 Cubic Feet Per Carton: 13.25</p>	<b>GC3616WCA</b> Wood	\$1446	\$1506	\$1559	\$1638	\$1746	\$1790	\$1884	\$2064	\$2153	\$2321	\$2553	\$2839
		OVERALL DIMENSIONS			SEAT DIMENSIONS			BACK DIMENSIONS					
		W	D	H	W	D	H	W	H				
		23	23	34.5	19	17.5	18	19	16.5				
Active weight 350 lbs.		SSU armcap option - <b>Add \$96 list upcharge</b>											
 <p><b>Dining Chair, Open Arms, Front Casters (Wood)</b> COM Yardage: 1.5 Freight Class: 250 Product Weight (lbs.): 50 Cubic Feet Per Carton: 13.25</p>	<b>GC3616WFC</b> Wood	\$1408	\$1452	\$1493	\$1550	\$1634	\$1663	\$1736	\$1870	\$1937	\$2064	\$2238	\$2453
		OVERALL DIMENSIONS			SEAT DIMENSIONS			BACK DIMENSIONS					
		W	D	H	W	D	H	W	H				
		23	23	34.5	19	17.5	18	19	16.5				
Active weight 350 lbs.		SSU armcap option - <b>Add \$96 list upcharge</b>											

PRIMACARE GUEST



model GC3620CA (HT)



model GC3625W (Wood)

STANDARD FEATURES

- Primacare is a family of products offering the most significant return on investment approach in the industry since every component can be repaired or replaced on site.
- **High traffic (HT) models:** Metal frame with die cast zinc connectors and metal-to-metal fasteners. Available in the following finishes: Black (BLK), Latte (LAB), Kalua (KAL), Mocha (J52), Shadow (SHW), Toast (TOA) and Tungsten (TUN).
- **Wood models:** Solid hardwood frame with die cast zinc connectors and metal-to-metal fastening. Available in the following finishes: Absolute (AAM), Charcoal Java (CJM), Cherry (ACM), Empire Mahogany (EMM), English Oak (EOM), Espresso Cafe (ECM), Fruitwood (TFM), Gray (HGM), Harvest Oak (HOM), Honey (AHM), Jet Onyx (JOM), Light Honey (LHM), Mahogany (TMM), Maple (AVM), Medium Walnut (MWM), Natural Walnut (NLW), Night (ASM), Noce Biondo (NBM), Noce Grigio (NGM), Noce Leggero (NEM), Noce Medio (NMM), Sandy Beach (SBM), Shaker Cherry (SKM), Silver Oak (SOM), Walnut (TWM), White (WHM), WC Cream (WTM) and Winter Cherry (WCM).
- Armcaps are securely fastened with metal-to-metal connectors which allow for field replacement if required.
- Easy grip forward extending armcap on models with arms.

- Wood armcaps are standard.
- Replaceable seat covers and replaceable and/or removable seat cushions are standard.
- Waterfall cleanout between the seat and back cushions.
- Models are standard with metal mesh seat deck. For behavioral health applications, the metal mesh seat deck can be covered with a solid moisture resistant surface, held in place with tamperproof fasteners. Contact your sales rep for a special quotation.
- All seat frames feature a wall saver design to prevent back contact with wall.
- Models ending in **CA / ARC**, have upholstered panel arm inserts closing the arm. (Closed arm panels are designed to be replaceable. Request a special quote to have them secured with tamperproof fasteners.)
- For Globalcare textile options, visit the website at [www.globalfurnituregroup.com](http://www.globalfurnituregroup.com).
- Can be upholstered in standard Global textiles if healthcare compliance is not required.
- It is recommended that High Traffic (HT) models be specified in textiles that meet or exceed 100,000 double rubs for added abrasion performance.
- Shipped fully assembled.
- **High traffic (HT) models are listed first, followed by wood models.**

OPTIONAL FEATURES

- Self-skinned urethane (SSU) armcaps are available. Please specify. *Refer to individual models for availability and pricing.*
- For moisture barrier (seat only), add \$119 list upcharge per seat. For Bariatric Models: GC3637W, GC3637CA and GC3637WCA - **Add \$183** list upcharge per seat.
- To add sealed seams to your product contact Customer Care. Upcharges vary.
- For Primacare tables, see page 56.

SUGGESTED APPLICATIONS

- Bariatric seating
- Guest seating
- Lobbies
- Lounge/Waiting
- Patient rooms
- Resident rooms

DESCRIPTION MODEL# / FEATURES STANDARD TEXTILE GRADES



**LB Armchair, Open Arms (HT)**  
COM Yardage: 1.75  
Freight Class: 250  
Product Weight (lbs.): 62  
Cubic Feet Per Carton: 17.5

MODEL#	COM	2	3	4	5	6	7	8	9	10	11	12
<b>GC3620</b> Metal	\$1827	\$1880	\$1928	\$1996	\$2090	\$2127	\$2211	\$2368	\$2447	\$2594	\$2796	\$3048
<b>GC3620F</b> Metal flex back	\$2284	\$2341	\$2387	\$2455	\$2550	\$2585	\$2669	\$2828	\$2906	\$3054	\$3257	\$3506
<b>OVERALL DIMENSIONS</b>			<b>SEAT DIMENSIONS</b>			<b>BACK DIMENSIONS</b>						
	<b>W</b>	<b>D</b>	<b>H</b>	<b>W</b>	<b>D</b>	<b>H</b>	<b>W</b>	<b>H</b>				
	25	27	33	20.5	17.5	18	20.5	15				

Active weight 500 lbs.  
SSU armcap option - **Add \$96 list upcharge**



**LB Armchair, Closed Arms (HT)**  
COM Yardage: 2.75  
Freight Class: 150  
Product Weight (lbs.): 72  
Cubic Feet Per Carton: 17.5

MODEL#	COM	2	3	4	5	6	7	8	9	10	11	12
<b>GC3620CA</b> Metal	\$2072	\$2158	\$2231	\$2338	\$2488	\$2544	\$2677	\$2923	\$3047	\$3277	\$3596	\$3989
<b>GC3620FCA</b> Metal flex back	\$2533	\$2619	\$2692	\$2797	\$2947	\$3005	\$3137	\$3384	\$3508	\$3738	\$4057	\$4451
<b>OVERALL DIMENSIONS</b>			<b>SEAT DIMENSIONS</b>			<b>BACK DIMENSIONS</b>						
	<b>W</b>	<b>D</b>	<b>H</b>	<b>W</b>	<b>D</b>	<b>H</b>	<b>W</b>	<b>H</b>				
	25	27	33	20.5	17.5	18	20.5	15				

Active weight 500 lbs.  
SSU armcap option - **Add \$96 list upcharge**

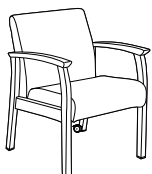

**LB Armchair, Open Arms, Rear Tip & Move Wheels (HT)**  
COM Yardage: 1.75  
Freight Class: 250  
Product Weight (lbs.): 62  
Cubic Feet Per Carton: 23

MODEL#	COM	2	3	4	5	6	7	8	9	10	11	12
<b>GC3620RC</b> Metal	\$1967	\$2021	\$2067	\$2136	\$2231	\$2266	\$2351	\$2508	\$2586	\$2735	\$2937	\$3187
<b>OVERALL DIMENSIONS</b>			<b>SEAT DIMENSIONS</b>			<b>BACK DIMENSIONS</b>						
	<b>W</b>	<b>D</b>	<b>H</b>	<b>W</b>	<b>D</b>	<b>H</b>	<b>W</b>	<b>H</b>				
	25	29.5	33	20.5	17.5	18	20.5	15				

Active weight 500 lbs.  
SSU armcap option - **Add \$96 list upcharge**

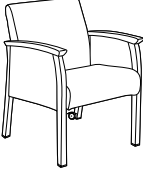
DESCRIPTION	MODEL#	STANDARD FABRIC GRADES											
		COM	2	3	4	5	6	7	8	9	10	11	12
 <p><b>GC3620CARC</b> Metal</p>		\$2219	\$2305	\$2378	\$2483	\$2632	\$2690	\$2823	\$3070	\$3193	\$3423	\$3742	\$4136
	<b>OVERALL DIMENSIONS</b>			<b>SEAT DIMENSIONS</b>			<b>BACK DIMENSIONS</b>						
		<b>W</b>	<b>D</b>	<b>H</b>	<b>W</b>	<b>D</b>	<b>H</b>	<b>W</b>	<b>H</b>				
		25	29.5	33	20.5	17.5	18	20.5	15				
<p><b>LB Armchair, Closed Arms, Rear Tip &amp; Move Wheels (HT)</b> COM Yardage: 2.75 Freight Class: 250 Product Weight (lbs.): 72 Cubic Feet Per Carton: 23</p>		<p>Active weight 500 lbs. SSU armcap option - <b>Add \$96 list upcharge</b></p>											

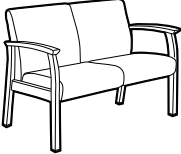
DESCRIPTION	MODEL#	STANDARD FABRIC GRADES											
		COM	2	3	4	5	6	7	8	9	10	11	12
 <p><b>GC3621</b> Metal</p>		\$2956	\$3059	\$3144	\$3269	\$3446	\$3515	\$3670	\$3960	\$4106	\$4380	\$4759	\$5221
	<b>OVERALL DIMENSIONS</b>			<b>SEAT DIMENSIONS</b>			<b>BACK DIMENSIONS</b>						
		<b>W</b>	<b>D</b>	<b>H</b>	<b>W</b>	<b>D</b>	<b>H</b>	<b>W</b>	<b>H</b>				
		45	27	33	40	17.5	18	40	15				
<p><b>LB Two Seat Chair, No Center Arm, Open Arms (HT)</b> COM Yardage: 3.25 Freight Class: 250 Product Weight (lbs.): 92 Cubic Feet Per Carton: 43</p>		<p>Active weight 500 lbs./seat SSU armcap option - <b>Add \$96 list upcharge</b></p>											

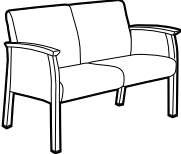
DESCRIPTION	MODEL#	STANDARD FABRIC GRADES											
		COM	2	3	4	5	6	7	8	9	10	11	12
 <p><b>GC3621CA</b> Metal</p>		\$3220	\$3336	\$3435	\$3580	\$3784	\$3861	\$4040	\$4380	\$4548	\$4861	\$5295	\$5835
	<b>OVERALL DIMENSIONS</b>			<b>SEAT DIMENSIONS</b>			<b>BACK DIMENSIONS</b>						
		<b>W</b>	<b>D</b>	<b>H</b>	<b>W</b>	<b>D</b>	<b>H</b>	<b>W</b>	<b>H</b>				
		45	27	33	40	17.5	18	40	15				
<p><b>LB Two Seat Chair, No Center Arm, Closed Arms (HT)</b> COM Yardage: 3.75 Freight Class: 250 Product Weight (lbs.): 100 Cubic Feet Per Carton: 43</p>		<p>Active weight 500 lbs./seat SSU armcap option - <b>Add \$96 list upcharge</b></p>											

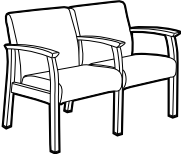
DESCRIPTION	MODEL#	STANDARD FABRIC GRADES											
		COM	2	3	4	5	6	7	8	9	10	11	12
 <p><b>GC3622</b> Metal</p>		\$3336	\$3440	\$3525	\$3650	\$3830	\$3894	\$4051	\$4341	\$4489	\$4760	\$5138	\$5602
	<b>OVERALL DIMENSIONS</b>			<b>SEAT DIMENSIONS</b>			<b>BACK DIMENSIONS</b>						
		<b>W</b>	<b>D</b>	<b>H</b>	<b>W</b>	<b>D</b>	<b>H</b>	<b>W</b>	<b>H</b>				
		46	27	33	20.5	17.5	18	20.5	15				
<p><b>LB Two Seat Chair, Full Center Arm, Open Arms (HT)</b> COM Yardage: 3.25 Freight Class: 250 Product Weight (lbs.): 98 Cubic Feet Per Carton: 43</p>		<p>Active weight 500 lbs./seat SSU armcap option - <b>Add \$143 list upcharge</b></p>											

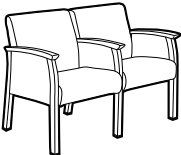
DESCRIPTION	MODEL#	STANDARD FABRIC GRADES											
		COM	2	3	4	5	6	7	8	9	10	11	12
 <p><b>GC3622CA</b> Metal</p>		\$3714	\$3857	\$3973	\$4148	\$4394	\$4486	\$4701	\$5106	\$5309	\$5685	\$6206	\$6851
	<b>OVERALL DIMENSIONS</b>			<b>SEAT DIMENSIONS</b>			<b>BACK DIMENSIONS</b>						
		<b>W</b>	<b>D</b>	<b>H</b>	<b>W</b>	<b>D</b>	<b>H</b>	<b>W</b>	<b>H</b>				
		46	27	33	20.5	17.5	18	20.5	15				
<p><b>LB Two Seat Chair, Full Center Arm, Closed Arms (HT)</b> COM Yardage: 4.5 Freight Class: 250 Product Weight (lbs.): 118 Cubic Feet Per Carton: 43</p>		<p>Active weight 500 lbs./seat SSU armcap option - <b>Add \$143 list upcharge</b></p>											

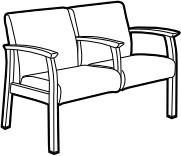
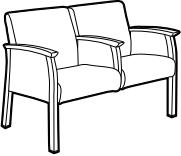
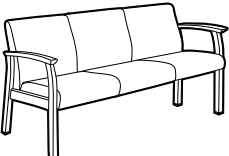
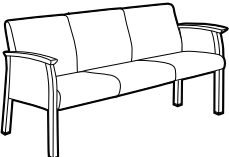
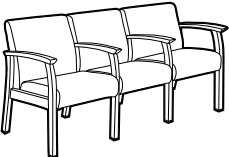
DESCRIPTION	MODEL#	STANDARD FABRIC GRADES											
		COM	2	3	4	5	6	7	8	9	10	11	12
 <p><b>LB Two Seat Chair, Half Center Arm, Open Arms (HT)</b>                      COM Yardage: 3.25                      Freight Class: 250                      Product Weight (lbs.): 94                      Cubic Feet Per Carton: 43</p>	<b>GC3623</b> Metal	\$3276	\$3377	\$3464	\$3587	\$3767	\$3834	\$3990	\$4280	\$4427	\$4699	\$5076	\$5544
		OVERALL DIMENSIONS			SEAT DIMENSIONS			BACK DIMENSIONS					
		W	D	H	W	D	H	W	H				
			46	27	33	20.5	17.5	18	20.5	15			
		Active weight 500 lbs./seat SSU armcap option - <b>Add \$143 list upcharge</b>											
 <p><b>LB Two Seat Chair, Half Center Arm, Closed Arms (HT)</b>                      COM Yardage: 4.5                      Freight Class: 250                      Product Weight (lbs.): 106                      Cubic Feet Per Carton: 43</p>	<b>GC3623CA</b> Metal	\$3651	\$3794	\$3911	\$4085	\$4331	\$4423	\$4639	\$5043	\$5246	\$5622	\$6143	\$6792
		OVERALL DIMENSIONS			SEAT DIMENSIONS			BACK DIMENSIONS					
		W	D	H	W	D	H	W	H				
			46	27	33	20.5	17.5	18	20.5	15			
		Active weight 500 lbs./seat SSU armcap option - <b>Add \$143 list upcharge</b>											
 <p><b>LB Three Seat Chair, No Center Arms, Open Arms (HT)</b>                      COM Yardage: 4.25                      Freight Class: 250                      Product Weight (lbs.): 137                      Cubic Feet Per Carton: 65.25</p>	<b>GC3624</b> Metal	\$4013	\$4134	\$4235	\$4383	\$4592	\$4692	\$4883	\$5184	\$5419	\$5679	\$6213	\$6783
		OVERALL DIMENSIONS			SEAT DIMENSIONS			BACK DIMENSIONS					
		W	D	H	W	D	H	W	H				
			65	27	33	60	17.5	18	60	15			
		Active weight 500 lbs./seat SSU armcap option - <b>Add \$96 list upcharge</b>											
 <p><b>LB Three Seat Chair, No Center Arms, Closed Arms (HT)</b>                      COM Yardage: 5.25                      Freight Class: 250                      Product Weight (lbs.): 147                      Cubic Feet Per Carton: 65.25</p>	<b>GC3624CA</b> Metal	\$4246	\$4412	\$4550	\$4752	\$5037	\$5147	\$5398	\$5870	\$6107	\$6544	\$7155	\$7907
		OVERALL DIMENSIONS			SEAT DIMENSIONS			BACK DIMENSIONS					
		W	D	H	W	D	H	W	H				
			65	27	33	60	17.5	18	60	15			
		Active weight 500 lbs./seat SSU armcap option - <b>Add \$96 list upcharge</b>											
 <p><b>LB Three Seat Chair, Full Center Arms, Open Arms (HT)</b>                      COM Yardage: 4.75                      Freight Class: 250                      Product Weight (lbs.): 162                      Cubic Feet Per Carton: 65.25</p>	<b>GC3625</b> Metal	\$4746	\$4897	\$5023	\$5204	\$5465	\$5563	\$5789	\$6217	\$6430	\$6827	\$7380	\$8059
		OVERALL DIMENSIONS			SEAT DIMENSIONS			BACK DIMENSIONS					
		W	D	H	W	D	H	W	H				
			69	27	33	20.5	17.5	18	20.5	15			
		Active weight 500 lbs./seat SSU armcap option - <b>Add \$188 list upcharge</b>											

# SEATING

# PRIMACARE™ GUEST P

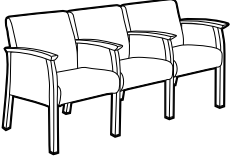
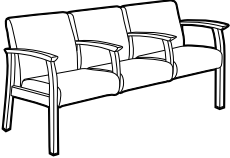
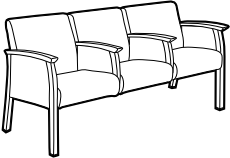
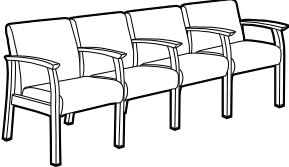
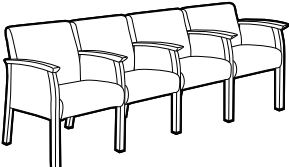
DESCRIPTION	MODEL#	STANDARD FABRIC GRADES												
		COM	2	3	4	5	6	7	8	9	10	11	12	
 <p><b>GC3625CA</b> Metal</p> <p><b>LB Three Seat Chair, Full Center Arms, Closed Arms (HT)</b> COM Yardage: 6.25 Freight Class: 250 Product Weight (lbs.): 172 Cubic Feet Per Carton: 65.25</p> <p>Active weight 500 lbs./seat SSU armcap option - <b>Add \$188 list upcharge</b></p>		COM	2	3	4	5	6	7	8	9	10	11	12	
	\$5251	\$5451	\$5615	\$5853	\$6196	\$6324	\$6623	\$7186	\$7468	\$7989	\$8713	\$9611		
	<b>OVERALL DIMENSIONS</b>			<b>SEAT DIMENSIONS</b>			<b>BACK DIMENSIONS</b>							
	W	D	H	W	D	H	W	H						
	69	27	33	20.5	17.5	18	20.5	15						
 <p><b>GC3626</b> Metal</p> <p><b>LB Three Seat Chair, Half Center Arms, Open Arms (HT)</b> COM Yardage: 4.75 Freight Class: 250 Product Weight (lbs.): 147 Cubic Feet Per Carton: 65.25</p> <p>Active weight 500 lbs./seat SSU armcap option - <b>Add \$188 list upcharge</b></p>		COM	2	3	4	5	6	7	8	9	10	11	12	
	\$4621	\$4771	\$4896	\$5080	\$5339	\$5436	\$5662	\$6091	\$6303	\$6701	\$7253	\$7933		
	<b>OVERALL DIMENSIONS</b>			<b>SEAT DIMENSIONS</b>			<b>BACK DIMENSIONS</b>							
	W	D	H	W	D	H	W	H						
	69	27	33	20.5	17.5	18	20.5	15						
 <p><b>GC3626CA</b> Metal</p> <p><b>LB Three Seat Chair, Half Center Arms, Closed Arms (HT)</b> COM Yardage: 6.25 Freight Class: 250 Product Weight (lbs.): 157 Cubic Feet Per Carton: 65.25</p> <p>Active weight 500 lbs./seat SSU armcap option - <b>Add \$188 list upcharge</b></p>		COM	2	3	4	5	6	7	8	9	10	11	12	
	\$5129	\$5326	\$5490	\$5734	\$6071	\$6201	\$6500	\$7061	\$7343	\$7865	\$8591	\$9488		
	<b>OVERALL DIMENSIONS</b>			<b>SEAT DIMENSIONS</b>			<b>BACK DIMENSIONS</b>							
	W	D	H	W	D	H	W	H						
	69	27	33	20.5	17.5	18	20.5	15						
 <p><b>GC3628</b> Metal</p> <p><b>LB Four Seat Chair, Full Center Arms, Open Arms (HT)</b> COM Yardage: 6 Freight Class: 150 Product Weight (lbs.): 197 Cubic Feet Per Carton: 43</p> <p>Active weight 500 lbs./seat SSU armcap option - <b>Add \$235 list upcharge</b></p> <p>• Shipped RTA (Ready to Assemble) in 2 cartons</p>		COM	2	3	4	5	6	7	8	9	10	11	12	
	\$6857	\$7046	\$7204	\$7433	\$7762	\$7888	\$8172	\$8712	\$8981	\$9482	\$10181	\$11041		
	<b>OVERALL DIMENSIONS</b>			<b>SEAT DIMENSIONS</b>			<b>BACK DIMENSIONS</b>							
	W	D	H	W	D	H	W	H						
	93	27	33	20.5	17.5	18	20.5	15						
 <p><b>GC3628CA</b> Metal</p> <p><b>LB Four Seat Chair, Full Center Arms, Closed Arms (HT)</b> COM Yardage: 8 Freight Class: 150 Product Weight (lbs.): 207 Cubic Feet Per Carton: 43</p> <p>Active weight 500 lbs./seat SSU armcap option - <b>Add \$235 list upcharge</b></p> <p>• Shipped RTA (Ready to Assemble) in 2 cartons</p>		COM	2	3	4	5	6	7	8	9	10	11	12	
	\$7484	\$7738	\$7946	\$8256	\$8691	\$8858	\$9238	\$9958	\$10317	\$10987	\$11915	\$13063		
	<b>OVERALL DIMENSIONS</b>			<b>SEAT DIMENSIONS</b>			<b>BACK DIMENSIONS</b>							
	W	D	H	W	D	H	W	H						
	93	27	33	20.5	17.5	18	20.5	15						

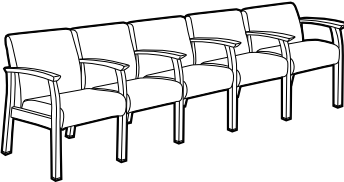
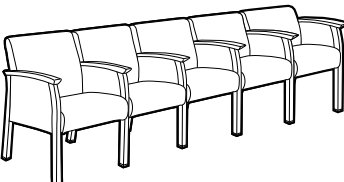
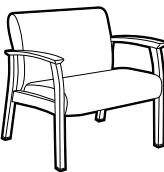
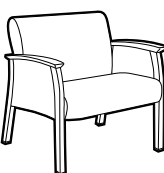
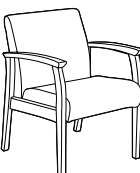
DESCRIPTION	MODEL#	STANDARD FABRIC GRADES											
		COM	2	3	4	5	6	7	8	9	10	11	12
 <p><b>LB Five Seat Chair, Full Center Arms, Open Arms (HT)</b>                      COM Yardage: 7.5                      Freight Class: 150                      Product Weight (lbs.): 249                      Cubic Feet Per Carton: 43</p>	<b>GC3630</b>												
	Metal	\$7527	\$7766	\$7962	\$8251	\$8660	\$8815	\$9173	\$9846	\$10185	\$10813	\$11684	\$12758
		OVERALL DIMENSIONS			SEAT DIMENSIONS			BACK DIMENSIONS					
		W	D	H	W	D	H	W	H				
		115	27	33	20.5	17.5	18	20.5	15				
Active weight 500 lbs./seat SSU armcap option - <b>Add \$280 list upcharge</b> • Shipped RTA (Ready to Assemble) in 2 cartons													
 <p><b>LB Five Seat Chair, Full Center Arms, Closed Arms (HT)</b>                      COM Yardage: 10                      Freight Class: 125                      Product Weight (lbs.): 261                      Cubic Feet Per Carton: 43</p>	<b>GC3630CA</b>												
	Metal	\$8281	\$8600	\$8862	\$9247	\$9792	\$9998	\$10476	\$11377	\$11825	\$12662	\$13823	\$15256
		OVERALL DIMENSIONS			SEAT DIMENSIONS			BACK DIMENSIONS					
		W	D	H	W	D	H	W	H				
		115	27	33	20.5	17.5	18	20.5	15				
Active weight 500 lbs./seat SSU armcap option - <b>Add \$280 list upcharge</b> • Shipped RTA (Ready to Assemble) in 2 cartons													
 <p><b>Bariatric LB Armchair, Open Arms (HT)</b>                      COM Yardage: 2.5                      Freight Class: 250                      Product Weight (lbs.): 78                      Cubic Feet Per Carton: 26.5</p>	<b>GC3637</b>												
	Metal	\$2384	\$2464	\$2531	\$2627	\$2762	\$2814	\$2934	\$3159	\$3272	\$3481	\$3770	\$4130
		OVERALL DIMENSIONS			SEAT DIMENSIONS			BACK DIMENSIONS					
		W	D	H	W	D	H	W	H				
		35	27	33	30	17.5	18	30	15				
Active weight 500 lbs. SSU armcap option - <b>Add \$96 list upcharge</b>													
 <p><b>Bariatric LB Armchair, Closed Arms (HT)</b>                      COM Yardage: 3.5                      Freight Class: 250                      Product Weight (lbs.): 88                      Cubic Feet Per Carton: 26.5</p>	<b>GC3637CA</b>												
	Metal	\$2628	\$2740	\$2832	\$2966	\$3158	\$3230	\$3398	\$3713	\$3868	\$4162	\$4568	\$5070
		OVERALL DIMENSIONS			SEAT DIMENSIONS			BACK DIMENSIONS					
		W	D	H	W	D	H	W	H				
		35	27	33	30	17.5	18	30	15				
Active weight 500 lbs. SSU armcap option - <b>Add \$96 list upcharge</b>													
 <p><b>LB Single Seat Armchair, Open Arms (Wood)</b>                      COM Yardage: 1.75                      Freight Class: 250                      Product Weight (lbs.): 50                      Cubic Feet Per Carton: 17.5</p>	<b>GC3620W</b>												
	Wood	\$1505	\$1558	\$1606	\$1674	\$1768	\$1805	\$1891	\$2049	\$2125	\$2272	\$2474	\$2726
		OVERALL DIMENSIONS			SEAT DIMENSIONS			BACK DIMENSIONS					
		W	D	H	W	D	H	W	H				
		25	27	33	20.5	17.5	18	20.5	15				
Active weight 350 lbs. SSU armcap option - <b>Add \$96 list upcharge</b>													
<b>GC3620WF</b>													
Wood flex back	\$1964	\$2018	\$2064	\$2132	\$2228	\$2263	\$2346	\$2505	\$2585	\$2731	\$2934	\$3184	

# SEATING

# PRIMACARE™ GUEST P

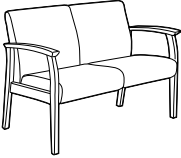
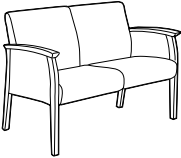
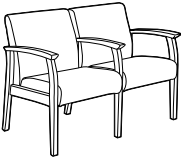
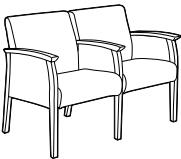
DESCRIPTION	MODEL#	STANDARD FABRIC GRADES											
		COM	2	3	4	5	6	7	8	9	10	11	12
 <p><b>LB Single Seat Armchair, Closed Arms (Wood)</b> COM Yardage: 2.75 Freight Class: 250 Product Weight (lbs.): 60 Cubic Feet Per Carton: 17.5</p> <p>Active weight 350 lbs. SSU armcap option - <b>Add \$96 list upcharge</b></p>	<b>GC3620WCA</b>	\$1703	\$1788	\$1862	\$1968	\$2118	\$2174	\$2306	\$2555	\$2678	\$2907	\$3226	\$3618
	<b>GC3620WFCA</b>	\$2161	\$2247	\$2319	\$2427	\$2574	\$2632	\$2766	\$3012	\$3136	\$3365	\$3685	\$4078
	<b>OVERALL DIMENSIONS</b>			<b>SEAT DIMENSIONS</b>			<b>BACK DIMENSIONS</b>						
	W	D	H	W	D	H	W	H					
	25	27	33	20.5	17.5	18	20.5	15					
 <p><b>LB Two Seat Chair, No Center Arm, Open Arms (Wood)</b> COM Yardage: 3.25 Freight Class: 300 Product Weight (lbs.): 80 Cubic Feet Per Carton: 43</p> <p>Active weight 350 lbs./seat SSU armcap option - <b>Add \$96 list upcharge</b></p>	<b>GC3621W</b>	\$2432	\$2534	\$2620	\$2744	\$2924	\$2990	\$3146	\$3435	\$3582	\$3856	\$4232	\$4697
	<b>OVERALL DIMENSIONS</b>			<b>SEAT DIMENSIONS</b>			<b>BACK DIMENSIONS</b>						
	W	D	H	W	D	H	W	H					
		45	27	33	40	17.5	18	40	15				
 <p><b>LB Two Seat Chair, No Center Arm, Closed Arms (Wood)</b> COM Yardage: 3.75 Freight Class: 250 Product Weight (lbs.): 90 Cubic Feet Per Carton: 43</p> <p>Active weight 350 lbs./seat SSU armcap option - <b>Add \$96 list upcharge</b></p>	<b>GC3621WCA</b>	\$2644	\$2763	\$2861	\$3006	\$3211	\$3287	\$3467	\$3807	\$3975	\$4288	\$4721	\$5260
	<b>OVERALL DIMENSIONS</b>			<b>SEAT DIMENSIONS</b>			<b>BACK DIMENSIONS</b>						
	W	D	H	W	D	H	W	H					
		45	27	33	40	17.5	18	40	15				
 <p><b>LB Two Seat Chair, Full Center Arm, Open Arms (Wood)</b> COM Yardage: 3.25 Freight Class: 250 Product Weight (lbs.): 86 Cubic Feet Per Carton: 43</p> <p>Active weight 350 lbs./seat SSU armcap option - <b>Add \$143 list upcharge</b></p>	<b>GC3622W</b>	\$2746	\$2850	\$2935	\$3060	\$3240	\$3304	\$3461	\$3751	\$3898	\$4170	\$4549	\$5013
	<b>OVERALL DIMENSIONS</b>			<b>SEAT DIMENSIONS</b>			<b>BACK DIMENSIONS</b>						
	W	D	H	W	D	H	W	H					
		46	27	33	20.5	17.5	18	20.5	15				
 <p><b>LB Two Seat Chair, Full Center Arm, Closed Arms (Wood)</b> COM Yardage: 4.5 Freight Class: 250 Product Weight (lbs.): 106 Cubic Feet Per Carton: 43</p> <p>Active weight 350 lbs./seat SSU armcap option - <b>Add \$143 list upcharge</b></p>	<b>GC3622WCA</b>	\$3052	\$3194	\$3311	\$3486	\$3732	\$3824	\$4039	\$4444	\$4647	\$5023	\$5546	\$6191
	<b>OVERALL DIMENSIONS</b>			<b>SEAT DIMENSIONS</b>			<b>BACK DIMENSIONS</b>						
	W	D	H	W	D	H	W	H					
		46	27	33	20.5	17.5	18	20.5	15				

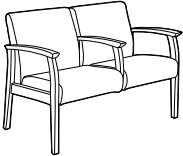

DESCRIPTION	MODEL#	STANDARD FABRIC GRADES											
		COM	2	3	4	5	6	7	8	9	10	11	12
 <p><b>GC3623W</b> Wood</p>		\$2696	\$2798	\$2883	\$3009	\$3185	\$3254	\$3410	\$3701	\$3847	\$4119	\$4498	\$4962
		<b>OVERALL DIMENSIONS</b>			<b>SEAT DIMENSIONS</b>			<b>BACK DIMENSIONS</b>					
		<b>W</b>	<b>D</b>	<b>H</b>	<b>W</b>	<b>D</b>	<b>H</b>	<b>W</b>	<b>H</b>				
<p><b>LB Two Seat Chair, Half Center Arm, Open Arms (Wood)</b> COM Yardage: 3.25 Freight Class: 300 Product Weight (lbs.): 82 Cubic Feet Per Carton: 43</p>		46	27	33	20.5	17.5	18	20.5	15				
		Active weight 350 lbs./seat SSU armcap option - <b>Add \$143 list upcharge</b>											

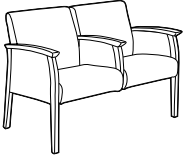
DESCRIPTION	MODEL#	STANDARD FABRIC GRADES											
		COM	2	3	4	5	6	7	8	9	10	11	12
 <p><b>GC3623WCA</b> Wood</p>		\$2999	\$3142	\$3258	\$3433	\$3680	\$3772	\$3986	\$4392	\$4594	\$4970	\$5494	\$6139
		<b>OVERALL DIMENSIONS</b>			<b>SEAT DIMENSIONS</b>			<b>BACK DIMENSIONS</b>					
		<b>W</b>	<b>D</b>	<b>H</b>	<b>W</b>	<b>D</b>	<b>H</b>	<b>W</b>	<b>H</b>				
<p><b>LB Two Seat Chair, Half Center Arm, Closed Arms (Wood)</b> COM Yardage: 4.5 Freight Class: 250 Product Weight (lbs.): 92 Cubic Feet Per Carton: 43</p>		46	27	33	20.5	17.5	18	20.5	15				
		Active weight 350 lbs./seat SSU armcap option - <b>Add \$143 list upcharge</b>											

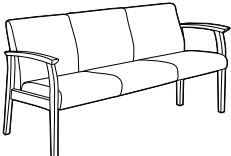
DESCRIPTION	MODEL#	STANDARD FABRIC GRADES											
		COM	2	3	4	5	6	7	8	9	10	11	12
 <p><b>GC3624W</b> Wood</p>		\$3289	\$3424	\$3535	\$3698	\$3930	\$4018	\$4222	\$4605	\$4795	\$5150	\$5644	\$6255
		<b>OVERALL DIMENSIONS</b>			<b>SEAT DIMENSIONS</b>			<b>BACK DIMENSIONS</b>					
		<b>W</b>	<b>D</b>	<b>H</b>	<b>W</b>	<b>D</b>	<b>H</b>	<b>W</b>	<b>H</b>				
<p><b>LB Three Seat Chair, No Center Arm, Open Arms (Wood)</b> COM Yardage: 4.25 Freight Class: 300 Product Weight (lbs.): 125 Cubic Feet Per Carton: 65.25</p>		65	27	33	60	17.5	18	60	15				
		Active weight 350 lbs./seat SSU armcap option - <b>Add \$96 list upcharge</b>											

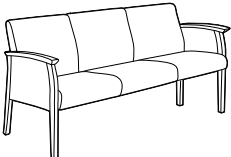
DESCRIPTION	MODEL#	STANDARD FABRIC GRADES											
		COM	2	3	4	5	6	7	8	9	10	11	12
 <p><b>GC3624WCA</b> Wood</p>		\$3490	\$3654	\$3792	\$3994	\$4281	\$4389	\$4640	\$5112	\$5349	\$5788	\$6397	\$7149
		<b>OVERALL DIMENSIONS</b>			<b>SEAT DIMENSIONS</b>			<b>BACK DIMENSIONS</b>					
		<b>W</b>	<b>D</b>	<b>H</b>	<b>W</b>	<b>D</b>	<b>H</b>	<b>W</b>	<b>H</b>				
<p><b>LB Three Seat Chair, No Center Arm, Closed Arms (Wood)</b> COM Yardage: 5.25 Freight Class: 250 Product Weight (lbs.): 135 Cubic Feet Per Carton: 65.25</p>		65	27	33	60	17.5	18	60	15				
		Active weight 350 lbs./seat SSU armcap option - <b>Add \$96 list upcharge</b>											

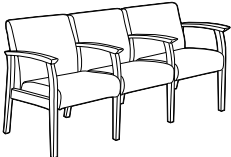
DESCRIPTION	MODEL#	STANDARD FABRIC GRADES											
		COM	2	3	4	5	6	7	8	9	10	11	12
 <p><b>GC3625W</b> Wood</p>		\$3905	\$4055	\$4181	\$4364	\$4623	\$4720	\$4948	\$5376	\$5587	\$5987	\$6537	\$7219
		<b>OVERALL DIMENSIONS</b>			<b>SEAT DIMENSIONS</b>			<b>BACK DIMENSIONS</b>					
		<b>W</b>	<b>D</b>	<b>H</b>	<b>W</b>	<b>D</b>	<b>H</b>	<b>W</b>	<b>H</b>				
<p><b>LB Three Seat Chair, Full Center Arms, Open Arms (Wood)</b> COM Yardage: 4.75 Freight Class: 250 Product Weight (lbs.): 150 Cubic Feet Per Carton: 65.25</p>		69	27	33	20.5	17.5	18	20.5	15				
		Active weight 350 lbs./seat SSU armcap option - <b>Add \$188 list upcharge</b>											

# SEATING

# PRIMACARE™ GUEST P

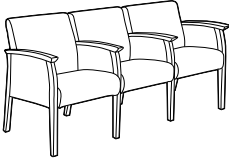
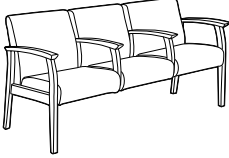
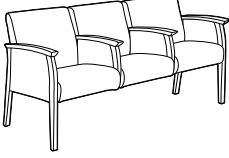
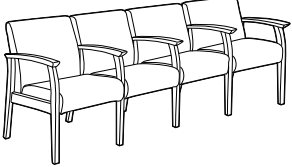
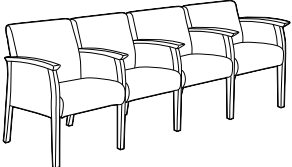
DESCRIPTION	MODEL#	STANDARD FABRIC GRADES											
		COM	2	3	4	5	6	7	8	9	10	11	12
 <p><b>LB Three Seat Chair, Full Center Arms, Closed Arms (Wood)</b>                      COM Yardage: 6.25                      Freight Class: 250                      Product Weight (lbs.): 160                      Cubic Feet Per Carton: 65.25</p>	<b>GC3625WCA</b> Wood	\$4316	\$4514	\$4677	\$4916	\$5259	\$5388	\$5687	\$6249	\$6531	\$7052	\$7778	\$8674
		<b>OVERALL DIMENSIONS</b>			<b>SEAT DIMENSIONS</b>			<b>BACK DIMENSIONS</b>					
		W	D	H	W	D	H	W	H				
			69	27	33	20.5	17.5	18	20.5	15			
<p>Active weight 350 lbs./seat                      SSU armcap option - <b>Add \$188 list upcharge</b></p>													
 <p><b>LB Three Seat Chair, Half Center Arms, Open Arms (Wood)</b>                      COM Yardage: 4.75                      Freight Class: 250                      Product Weight (lbs.): 135                      Cubic Feet Per Carton: 65.25</p>	<b>GC3626W</b> Wood	\$3802	\$3952	\$4078	\$4261	\$4520	\$4617	\$4844	\$5272	\$5484	\$5884	\$6434	\$7114
		<b>OVERALL DIMENSIONS</b>			<b>SEAT DIMENSIONS</b>			<b>BACK DIMENSIONS</b>					
		W	D	H	W	D	H	W	H				
			69	27	33	20.5	17.5	18	20.5	15			
<p>Active weight 350 lbs./seat                      SSU armcap option - <b>Add \$188 list upcharge</b></p>													
 <p><b>LB Three Seat Chair, Half Center Arms, Closed Arms (Wood)</b>                      COM Yardage: 6.25                      Freight Class: 250                      Product Weight (lbs.): 145                      Cubic Feet Per Carton: 65.25</p>	<b>GC3626WCA</b> Wood	\$4215	\$4412	\$4576	\$4817	\$5158	\$5289	\$5587	\$6148	\$6430	\$6950	\$7677	\$8573
		<b>OVERALL DIMENSIONS</b>			<b>SEAT DIMENSIONS</b>			<b>BACK DIMENSIONS</b>					
		W	D	H	W	D	H	W	H				
			69	27	33	20.5	17.5	18	20.5	15			
<p>Active weight 350 lbs./seat                      SSU armcap option - <b>Add \$188 list upcharge</b></p>													
 <p><b>LB Four Seat Chair, Full Center Arms, Open Arms (Wood)</b>                      COM Yardage: 6                      Freight Class: 150                      Product Weight (lbs.): 185                      Cubic Feet Per Carton: 43</p>	<b>GC3628W</b> Wood	\$5646	\$5835	\$5993	\$6225	\$6551	\$6677	\$6962	\$7503	\$7770	\$8272	\$8971	\$9830
		<b>OVERALL DIMENSIONS</b>			<b>SEAT DIMENSIONS</b>			<b>BACK DIMENSIONS</b>					
		W	D	H	W	D	H	W	H				
			93	27	33	20.5	17.5	18	20.5	15			
<p>Active weight 350 lbs./seat                      SSU armcap option - <b>Add \$235 list upcharge</b></p> <p>• Shipped RTA (Ready to Assemble) in 2 cartons</p>													
 <p><b>LB Four Seat Chair, Full Center Arms, Closed Arms (Wood)</b>                      COM Yardage: 8                      Freight Class: 150                      Product Weight (lbs.): 195                      Cubic Feet Per Carton: 43</p>	<b>GC3628WCA</b> Wood	\$6155	\$6410	\$6619	\$6926	\$7362	\$7530	\$7910	\$8632	\$8989	\$9660	\$10587	\$11734
		<b>OVERALL DIMENSIONS</b>			<b>SEAT DIMENSIONS</b>			<b>BACK DIMENSIONS</b>					
		W	D	H	W	D	H	W	H				
			93	27	33	20.5	17.5	18	20.5	15			
<p>Active weight 350 lbs./seat                      SSU armcap option - <b>Add \$235 list upcharge</b></p> <p>• Shipped RTA (Ready to Assemble) in 2 cartons</p>													

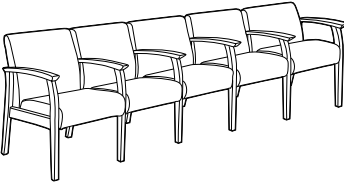
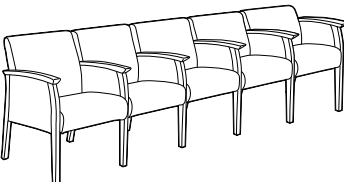
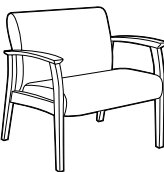
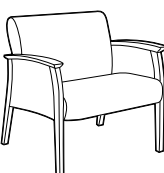
DESCRIPTION	MODEL#	STANDARD FABRIC GRADES											
		COM	2	3	4	5	6	7	8	9	10	11	12
 <p><b>LB Five Seat Chair, Full Center Arms, Open Arms (Wood)</b>                      COM Yardage: 7.5                      Freight Class: 150                      Product Weight (lbs.): 227                      Cubic Feet Per Carton: 43</p>	<b>GC3630W</b> Wood	\$6193	\$6432	\$6628	\$6917	\$7325	\$7480	\$7838	\$8513	\$8851	\$9477	\$10348	\$11424
		<b>OVERALL DIMENSIONS</b>			<b>SEAT DIMENSIONS</b>			<b>BACK DIMENSIONS</b>					
		W	D	H	W	D	H	W	H				
			115	27	33	20.5	17.5	18	20.5	15			
Active weight 350 lbs./seat SSU armcap option - <b>Add \$280 list upcharge</b> • Shipped RTA (Ready to Assemble) in 2 cartons													
 <p><b>LB Five Seat Chair, Full Center Arms, Closed Arms (Wood)</b>                      COM Yardage: 10                      Freight Class: 250                      Product Weight (lbs.): 237                      Cubic Feet Per Carton: 43</p>	<b>GC3630WCA</b> Wood	\$6804	\$7122	\$7382	\$7767	\$8314	\$8521	\$8999	\$9899	\$10347	\$11182	\$12343	\$13777
		<b>OVERALL DIMENSIONS</b>			<b>SEAT DIMENSIONS</b>			<b>BACK DIMENSIONS</b>					
		W	D	H	W	D	H	W	H				
			115	27	33	20.5	17.5	18	20.5	15			
Active weight 350 lbs./seat SSU armcap option - <b>Add \$280 list upcharge</b> • Shipped RTA (Ready to Assemble) in 2 cartons													
 <p><b>Bariatric LB Armchair, Open Arms (Wood)</b>                      COM Yardage: 2.5                      Freight Class: 250                      Product Weight (lbs.): 66                      Cubic Feet Per Carton: 26.5</p>	<b>GC3637W</b> Wood	\$1963	\$2040	\$2106	\$2204	\$2340	\$2392	\$2510	\$2737	\$2849	\$3058	\$3347	\$3707
		<b>OVERALL DIMENSIONS</b>			<b>SEAT DIMENSIONS</b>			<b>BACK DIMENSIONS</b>					
		W	D	H	W	D	H	W	H				
			35	27	33	30	17.5	18	30	15			
Active weight 500 lbs. SSU armcap option - <b>Add \$96 list upcharge</b>													
 <p><b>Bariatric LB Armchair, Closed Arms (Wood)</b>                      COM Yardage: 3.5                      Freight Class: 250                      Product Weight (lbs.): 76                      Cubic Feet Per Carton: 26.5</p>	<b>GC3637WCA</b> Wood	\$2146	\$2257	\$2349	\$2483	\$2675	\$2748	\$2916	\$3230	\$3387	\$3680	\$4086	\$4586
		<b>OVERALL DIMENSIONS</b>			<b>SEAT DIMENSIONS</b>			<b>BACK DIMENSIONS</b>					
		W	D	H	W	D	H	W	H				
			35	27	33	30	17.5	18	30	15			
Active weight 500 lbs. SSU armcap option - <b>Add \$96 list upcharge</b>													

PRIMACARE PATIENT



model GC3631 (HT)



model GC3632WCA (Wood)

STANDARD FEATURES

- Primacare is a family of products offering the most significant return on investment approach in the industry since every component can be repaired or replaced on site.
- **High traffic (HT) models:** Metal frame with die cast zinc connectors and metal-to-metal fasteners. Available in the following finishes: Black (BLK), Latte (LAB), Kalua (KAL), Mocha (J52), Shadow (SHW), Toast (TOA) and Tungsten (TUN).
- **Wood models:** Solid hardwood frame with die cast zinc connectors and metal-to-metal fastening. Available in the following finishes: Absolute (AAM), Charcoal Java (CJM), Cherry (ACM), Empire Mahogany (EMM), English Oak (EOM), Espresso Cafe (ECM), Fruitwood (TFM), Gray (HGM), Harvest Oak (HOM), Honey (AHM), Jet Onyx (JOM), Light Honey (LHM), Mahogany (TMM), Maple (AVM), Medium Walnut (MWM), Natural Walnut (NLW), Night (ASM), Noce Biondo (NBM), Noce Grigio (NGM), Noce Leggero (NEM), Noce Medio (NMM), Sandy Beach (SBM), Shaker Cherry (SKM), Silver Oak (SOM), Walnut (TWM), White (WHM), WC Cream (WTM) and Winter Cherry (WCM).
- Armcaps are securely fastened with metal-to-metal connectors which allow for field replacement if required.
- Easy grip forward extending armcap on models with arms.
- Replaceable seat covers and replaceable and/or removable seat cushions are standard.

- Wood armcaps are standard.
- Waterfall cleanout between the seat and back cushions.
- Models are standard with metal mesh seat deck. For behavioral health applications, the metal mesh seat deck can be covered with a solid moisture resistant surface, held in place with tamperproof fasteners. Contact your sales rep for a special quotation.
- All seat frames feature a wall saver design to prevent back contact with wall.
- Models ending in **CA / ARC**, have upholstered panel arm inserts closing the arm. (Closed arm panels are designed to be replaceable. Request a special quote to have them secured with tamperproof fasteners.)
- For Globalcare textile options, visit the website at [www.globalfurnituregroup.com](http://www.globalfurnituregroup.com).
- Can be upholstered in standard Global textiles if healthcare compliance is not required.
- It is recommended that High Traffic (HT) models be specified in textiles that meet or exceed 100,000 double rubs for added abrasion performance.
- Shipped fully assembled.

OPTIONAL FEATURES

- Self-skinned urethane (SSU) armcaps are available. Please specify. *Refer to individual models for availability and pricing.*
- For moisture barrier (seat only), add **\$119** list upcharge per seat. For Bariatric Models: GC3638W, GC3638WCA, GC3639W, GC3639WCA, GC3640W, GC3640WCA, GC3656W and GC3656WCA - **Add \$183** list upcharge per seat.
- To add sealed seams to your product contact Customer Care. Upcharges vary.
- For Primacare tables, see page 56.

SUGGESTED APPLICATIONS

- Bariatric seating
- Guest seating
- Lobbies
- Lounge/Waiting
- Patient rooms
- Resident rooms
- Treatment/Exam rooms

• **High traffic (HT) models are listed first, followed by wood models.**

DESCRIPTION	MODEL# / FEATURES	STANDARD TEXTILE GRADES											
		COM	2	3	4	5	6	7	8	9	10	11	12
<p><b>MB Armchair Open Arms (HT)</b> COM Yardage: 1.75 Freight Class: 250 Product Weight (lbs.): 64 Cubic Feet Per Carton: 17.5</p>	GC3631 Metal	\$1928	\$1984	\$2032	\$2100	\$2194	\$2231	\$2314	\$2471	\$2551	\$2697	\$2900	\$3152
	GC3631F Metal flex back	\$2394	\$2445	\$2495	\$2561	\$2659	\$2692	\$2778	\$2936	\$3014	\$3161	\$3363	\$3613
	<b>OVERALL DIMENSIONS</b>	<b>W</b>	<b>D</b>	<b>H</b>	<b>SEAT DIMENSIONS</b>			<b>BACK DIMENSIONS</b>					
	25	27	36.5	20.5	17.5	18	20.5	18					
	Active weight 500 lbs. SSU armcap option - <b>Add \$96 list upcharge</b>												
<p><b>MB Armchair Closed Arms (HT)</b> COM Yardage: 2.75 Freight Class: 150 Product Weight (lbs.): 76 Cubic Feet Per Carton: 17.5</p>	GC3631CA Metal	\$2210	\$2296	\$2368	\$2477	\$2624	\$2682	\$2814	\$3061	\$3185	\$3415	\$3734	\$4126
	GC3631FCA Metal flex back	\$2672	\$2757	\$2829	\$2937	\$3085	\$3143	\$3276	\$3522	\$3646	\$3876	\$4195	\$4588
	<b>OVERALL DIMENSIONS</b>	<b>W</b>	<b>D</b>	<b>H</b>	<b>SEAT DIMENSIONS</b>			<b>BACK DIMENSIONS</b>					
	25	27	36.5	20.5	17.5	18	20.5	18					
	Active weight 500 lbs. SSU armcap option - <b>Add \$96 list upcharge</b>												
<p><b>MB Armchair Open Arms, Rear Tip &amp; Move Wheels (HT)</b> COM Yardage: 1.75 Freight Class: 250 Product Weight (lbs.): 64 Cubic Feet Per Carton: 23</p>	GC3631RC Metal	\$2062	\$2118	\$2164	\$2233	\$2328	\$2363	\$2448	\$2606	\$2683	\$2832	\$3034	\$3284
	<b>OVERALL DIMENSIONS</b>	<b>W</b>	<b>D</b>	<b>H</b>	<b>SEAT DIMENSIONS</b>			<b>BACK DIMENSIONS</b>					
		25	29.5	36.5	20.5	17.5	18	20.5	18				
	Active weight 500 lbs. SSU armcap option - <b>Add \$96 list upcharge</b>												

DESCRIPTION	MODEL#	STANDARD FABRIC GRADES												
		COM	2	3	4	5	6	7	8	9	10	11	12	
	<b>GC3631CARC</b>	\$2358	\$2444	\$2516	\$2624	\$2771	\$2830	\$2963	\$3208	\$3333	\$3563	\$3882	\$4275	
	Metal													
		OVERALL DIMENSIONS			SEAT DIMENSIONS			BACK DIMENSIONS						
		W	D	H	W	D	H	W	H					
		25	29.5	36.5	20.5	17.5	18	20.5	18					
<b>MB Armchair, Closed Arms, Rear Tip &amp; Move Wheels (HT)</b> COM Yardage: 2.75 Freight Class: 250 Product Weight (lbs.): 76 Cubic Feet Per Carton: 23		Active weight 500 lbs. SSU armcap option - <b>Add \$96 list upcharge</b>												

DESCRIPTION	MODEL#	STANDARD FABRIC GRADES												
		COM	2	3	4	5	6	7	8	9	10	11	12	
	<b>GC3632</b>	\$2158	\$2227	\$2288	\$2374	\$2497	\$2543	\$2649	\$2853	\$2954	\$3143	\$3403	\$3726	
	Metal													
	<b>GC3632F</b>	\$2620	\$2688	\$2749	\$2835	\$2958	\$3004	\$3110	\$3314	\$3414	\$3603	\$3865	\$4187	
	Metal flex back													
		OVERALL DIMENSIONS			SEAT DIMENSIONS			BACK DIMENSIONS						
		W	D	H	W	D	H	W	H					
		25	27	48.5	20.5	17.5	18	20.5	30					
<b>HB Armchair, Open Arms, Split Back (HT)</b> COM Yardage: 2.25 Freight Class: 250 Product Weight (lbs.): 72 Cubic Feet Per Carton: 27.5		Active weight 500 lbs. Fold away headrest. SSU armcap option - <b>Add \$96 list upcharge</b>												

DESCRIPTION	MODEL#	STANDARD FABRIC GRADES												
		COM	2	3	4	5	6	7	8	9	10	11	12	
	<b>GC3632CA</b>	\$2446	\$2540	\$2619	\$2733	\$2899	\$2960	\$3105	\$3374	\$3507	\$3759	\$4108	\$4538	
	Metal													
	<b>GC3632FCA</b>	\$2905	\$3000	\$3080	\$3196	\$3359	\$3420	\$3565	\$3835	\$3969	\$4221	\$4569	\$4999	
	Metal flex back													
		OVERALL DIMENSIONS			SEAT DIMENSIONS			BACK DIMENSIONS						
		W	D	H	W	D	H	W	H					
		25	27	48.5	20.5	17.5	18	20.5	30					
<b>HB Armchair, Closed Arms, Split Back (HT)</b> COM Yardage: 3 Freight Class: 250 Product Weight (lbs.): 84 Cubic Feet Per Carton: 27.5		Active weight 500 lbs. Fold away headrest. SSU armcap option - <b>Add \$96 list upcharge</b>												

DESCRIPTION	MODEL#	STANDARD FABRIC GRADES												
		COM	2	3	4	5	6	7	8	9	10	11	12	
	<b>GC3632RC</b>	\$2306	\$2374	\$2436	\$2522	\$2645	\$2691	\$2797	\$3001	\$3101	\$3290	\$3552	\$3874	
	Metal													
		OVERALL DIMENSIONS			SEAT DIMENSIONS			BACK DIMENSIONS						
		W	D	H	W	D	H	W	H					
		25	29.5	48.5	20.5	17.5	18	20.5	30					
<b>HB Armchair, Open Arms, Split Back, Rear Tip &amp; Move Wheels (HT)</b> COM Yardage: 2.25 Freight Class: 250 Product Weight (lbs.): 72 Cubic Feet Per Carton: 27.5		Active weight 500 lbs. Fold away headrest. SSU armcap option - <b>Add \$96 list upcharge</b>												

DESCRIPTION	MODEL#	STANDARD FABRIC GRADES												
		COM	2	3	4	5	6	7	8	9	10	11	12	
	<b>GC3632CARC</b>	\$2592	\$2687	\$2767	\$2880	\$3045	\$3107	\$3251	\$3521	\$3656	\$3906	\$4255	\$4685	
	Metal													
		OVERALL DIMENSIONS			SEAT DIMENSIONS			BACK DIMENSIONS						
		W	D	H	W	D	H	W	H					
		25	29.5	48.5	20.5	17.5	18	20.5	30					
<b>HB Armchair, Closed Arms, Split Back, Rear Tip &amp; Move Wheels (HT)</b> COM Yardage: 3 Freight Class: 250 Product Weight (lbs.): 84 Cubic Feet Per Carton: 27.5		Active weight 500 lbs. Fold away headrest. SSU armcap option - <b>Add \$96 list upcharge</b>												

## DESCRIPTION

## MODEL#

## STANDARD FABRIC GRADES

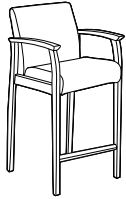

Designed to immobilize the pelvis and hip joints after surgery.

### LB Hip Armchair, Open Arms - Post Surgery (HT)

COM Yardage: 1.5  
Freight Class: 250  
Product Weight (lbs.): 67  
Cubic Feet Per Carton: 20

Active weight 500 lbs.  
SSU armcap option - **Add \$96 list upcharge**

COM	2	3	4	5	6	7	8	9	10	11	12	
<b>GC3636</b>	<b>\$2496</b>	<b>\$2542</b>	<b>\$2584</b>	<b>\$2641</b>	<b>\$2723</b>	<b>\$2756</b>	<b>\$2826</b>	<b>\$2960</b>	<b>\$3028</b>	<b>\$3154</b>	<b>\$3329</b>	<b>\$3542</b>
Metal												
OVERALL DIMENSIONS			SEAT DIMENSIONS			BACK DIMENSIONS						
W	D	H	W	D	H	W	H					
23	26	40.5	19	17.5	25.5	19	15.5					



### Bariatric MB Armchair, Open Arms (HT)

COM Yardage: 2.75  
Freight Class: 250  
Product Weight (lbs.): 94  
Cubic Feet Per Carton: 30.5

Active weight 500 lbs.  
SSU armcap option - **Add \$96 list upcharge**

COM	2	3	4	5	6	7	8	9	10	11	12	
<b>GC3638</b>	<b>\$2481</b>	<b>\$2567</b>	<b>\$2640</b>	<b>\$2748</b>	<b>\$2895</b>	<b>\$2953</b>	<b>\$3086</b>	<b>\$3332</b>	<b>\$3457</b>	<b>\$3686</b>	<b>\$4007</b>	<b>\$4399</b>
Metal												
OVERALL DIMENSIONS			SEAT DIMENSIONS			BACK DIMENSIONS						
W	D	H	W	D	H	W	H					
35	27	36.5	30	17.5	18	30	18					



### Bariatric MB Armchair, Closed Arms (HT)

COM Yardage: 3.75  
Freight Class: 250  
Product Weight (lbs.): 104  
Cubic Feet Per Carton: 30.5

Active weight 500 lbs.  
SSU armcap option - **Add \$96 list upcharge**

COM	2	3	4	5	6	7	8	9	10	11	12	
<b>GC3638CA</b>	<b>\$2762</b>	<b>\$2879</b>	<b>\$2978</b>	<b>\$3123</b>	<b>\$3327</b>	<b>\$3403</b>	<b>\$3583</b>	<b>\$3920</b>	<b>\$4091</b>	<b>\$4403</b>	<b>\$4837</b>	<b>\$5376</b>
Metal												
OVERALL DIMENSIONS			SEAT DIMENSIONS			BACK DIMENSIONS						
W	D	H	W	D	H	W	H					
35	27	36.5	30	17.5	18	30	18					



### Bariatric HB Armchair, Open Arms, Split Back (HT)

COM Yardage: 3.75  
Freight Class: 250  
Product Weight (lbs.): 77  
Cubic Feet Per Carton: 33

Active weight 500 lbs. Fold away headrest.  
SSU armcap option - **Add \$96 list upcharge**

COM	2	3	4	5	6	7	8	9	10	11	12	
<b>GC3639</b>	<b>\$2762</b>	<b>\$2879</b>	<b>\$2978</b>	<b>\$3123</b>	<b>\$3327</b>	<b>\$3403</b>	<b>\$3583</b>	<b>\$3920</b>	<b>\$4091</b>	<b>\$4403</b>	<b>\$4837</b>	<b>\$5376</b>
Metal												
OVERALL DIMENSIONS			SEAT DIMENSIONS			BACK DIMENSIONS						
W	D	H	W	D	H	W	H					
35	27	48.5	30	17.5	18	30	30					





### Bariatric HB Armchair, Closed Arms, Split Back (HT)

COM Yardage: 4.75  
Freight Class: 250  
Product Weight (lbs.): 108  
Cubic Feet Per Carton: 33

Active weight 500 lbs. Fold away headrest.  
SSU armcap option - **Add \$96 list upcharge**

COM	2	3	4	5	6	7	8	9	10	11	12	
<b>GC3639CA</b>	<b>\$3039</b>	<b>\$3191</b>	<b>\$3313</b>	<b>\$3498</b>	<b>\$3756</b>	<b>\$3854</b>	<b>\$4083</b>	<b>\$4508</b>	<b>\$4723</b>	<b>\$5120</b>	<b>\$5670</b>	<b>\$6353</b>
Metal												
OVERALL DIMENSIONS			SEAT DIMENSIONS			BACK DIMENSIONS						
W	D	H	W	D	H	W	H					
35	27	48.5	30	17.5	18	30	30					

DESCRIPTION	MODEL#	STANDARD FABRIC GRADES											
		COM	2	3	4	5	6	7	8	9	10	11	12
	<b>GC3655</b> Metal	\$2011	\$2088	\$2155	\$2251	\$2387	\$2438	\$2560	\$2783	\$2896	\$3105	\$3395	\$3754
	<b>GC3655F</b> Metal flex back	\$2472	\$2549	\$2616	\$2714	\$2851	\$2902	\$3021	\$3246	\$3358	\$3567	\$3858	\$4216
		OVERALL DIMENSIONS			SEAT DIMENSIONS			BACK DIMENSIONS					
		W	D	H	W	D	H	W	H				
		25	27	48.5	20.5	17.5	18	20.5	30				
<b>HB Armchair, Open Arms (HT)</b> COM Yardage: 2.5 Freight Class: 250 Product Weight (lbs.): 72 Cubic Feet Per Carton: 27.5 Active weight 500 lbs. SSU armcap option - <b>Add \$96 list upcharge</b>													

DESCRIPTION	MODEL#	STANDARD FABRIC GRADES											
		COM	2	3	4	5	6	7	8	9	10	11	12
	<b>GC3655CA</b> Metal	\$2299	\$2400	\$2487	\$2614	\$2790	\$2856	\$3012	\$3305	\$3449	\$3721	\$4100	\$4564
	<b>GC3655FCA</b> Metal flex back	\$2757	\$2861	\$2946	\$3071	\$3248	\$3315	\$3472	\$3764	\$3909	\$4181	\$4559	\$5024
		OVERALL DIMENSIONS			SEAT DIMENSIONS			BACK DIMENSIONS					
		W	D	H	W	D	H	W	H				
		25	27	48.5	20.5	17.5	18	20.5	30				
<b>HB Armchair, Closed Arms (HT)</b> COM Yardage: 3.25 Freight Class: 250 Product Weight (lbs.): 84 Cubic Feet Per Carton: 27.5 Active weight 500 lbs. SSU armcap option - <b>Add \$96 list upcharge</b>													

DESCRIPTION	MODEL#	STANDARD FABRIC GRADES											
		COM	2	3	4	5	6	7	8	9	10	11	12
	<b>GC3655RC</b> Metal	\$2158	\$2236	\$2303	\$2400	\$2535	\$2588	\$2706	\$2932	\$3044	\$3253	\$3543	\$3903
			OVERALL DIMENSIONS			SEAT DIMENSIONS			BACK DIMENSIONS				
		W	D	H	W	D	H	W	H				
		25	29.5	48.5	20.5	17.5	18	20.5	30				
<b>HB Armchair, Open Arms, Rear Tip &amp; Move Wheels (HT)</b> COM Yardage: 2.5 Freight Class: 250 Product Weight (lbs.): 72 Cubic Feet Per Carton: 27.5 Active weight 500 lbs. SSU armcap option - <b>Add \$96 list upcharge</b>													

DESCRIPTION	MODEL#	STANDARD FABRIC GRADES											
		COM	2	3	4	5	6	7	8	9	10	11	12
	<b>GC3655CARC</b> Metal	\$2445	\$2547	\$2633	\$2758	\$2937	\$3003	\$3159	\$3452	\$3596	\$3869	\$4246	\$4711
			OVERALL DIMENSIONS			SEAT DIMENSIONS			BACK DIMENSIONS				
		W	D	H	W	D	H	W	H				
		25	29.5	48.5	20.5	17.5	18	20.5	30				
<b>HB Armchair, Open Arms, Rear Tip &amp; Move Wheels (HT)</b> COM Yardage: 3.25 Freight Class: 250 Product Weight (lbs.): 84 Cubic Feet Per Carton: 27.5 Active weight 500 lbs. SSU armcap option - <b>Add \$96 list upcharge</b>													

DESCRIPTION	MODEL#	STANDARD FABRIC GRADES											
		COM	2	3	4	5	6	7	8	9	10	11	12
	<b>GC3656</b> Metal	\$2559	\$2671	\$2763	\$2897	\$3088	\$3162	\$3329	\$3644	\$3801	\$4092	\$4499	\$5001
			OVERALL DIMENSIONS			SEAT DIMENSIONS			BACK DIMENSIONS				
		W	D	H	W	D	H	W	H				
		35	27	48.5	30	17.5	18	30	30				
<b>Bariatric HB Armchair, Open Arms (HT)</b> COM Yardage: 3.5 Freight Class: 250 Product Weight (lbs.): 79 Cubic Feet Per Carton: 33 Active weight 500 lbs. SSU armcap option - <b>Add \$96 list upcharge</b>													

DESCRIPTION	MODEL#	STANDARD FABRIC GRADES												
		COM	2	3	4	5	6	7	8	9	10	11	12	
<p><b>Bariatric HB Armchair, Closed Arms (HT)</b> COM Yardage: 4.5 Freight Class: 250 Product Weight (lbs.): 108 Cubic Feet Per Carton: 33</p>	<b>GC3656CA</b> Metal	\$2840	\$2983	\$3100	\$3274	\$3520	\$3612	\$3827	\$4232	\$4435	\$4810	\$5332	\$5977	
		<b>OVERALL DIMENSIONS</b>			<b>SEAT DIMENSIONS</b>			<b>BACK DIMENSIONS</b>						
		W	D	H	W	D	H	W	H					
		35	27	48.5	30	17.5	18	30	30					
<p>Active weight 500 lbs. SSU armcap option - <b>Add \$96 list upcharge</b></p>														
<p>Designed to immobilize the pelvis and hip joints after surgery.</p> <p><b>Wide Hip Armchair, Open Arms - Post Surgery (HT)</b> COM Yardage: 1.5 Freight Class: 250 Product Weight (lbs.): 78 Cubic Feet Per Carton: 20</p>	<b>GC3657</b> Metal	\$3073	\$3120	\$3161	\$3219	\$3301	\$3331	\$3404	\$3538	\$3606	\$3732	\$3907	\$4120	
		<b>OVERALL DIMENSIONS</b>			<b>SEAT DIMENSIONS</b>			<b>BACK DIMENSIONS</b>						
		W	D	H	W	D	H	W	H					
		28	25	41	24	17.5	26	24	15.5					
<p>Active weight 500 lbs. SSU armcap option - <b>Add \$96 list upcharge</b></p>														
<p><b>MB Armchair, Open Arms (Wood)</b> COM Yardage: 1.75 Freight Class: 250 Product Weight (lbs.): 52 Cubic Feet Per Carton: 20</p>	<b>GC3631W</b> Wood	\$1607	\$1663	\$1711	\$1779	\$1873	\$1909	\$1993	\$2150	\$2228	\$2376	\$2579	\$2831	
		<b>GC3631WF</b> Wood flex back	\$2037	\$2093	\$2139	\$2207	\$2303	\$2337	\$2421	\$2580	\$2658	\$2806	\$3009	\$3259
			<b>OVERALL DIMENSIONS</b>			<b>SEAT DIMENSIONS</b>			<b>BACK DIMENSIONS</b>					
			W	D	H	W	D	H	W	H				
25	27		36.5	20.5	17.5	18	20.5	18						
<p>Active weight 350 lbs. SSU armcap option - <b>Add \$96 list upcharge</b></p>														
<p><b>MB Armchair, Closed Arms (Wood)</b> COM Yardage: 2.75 Freight Class: 250 Product Weight (lbs.): 62 Cubic Feet Per Carton: 17.5</p>	<b>GC3631WCA</b> Wood	\$1824	\$1910	\$1982	\$2090	\$2237	\$2296	\$2429	\$2674	\$2799	\$3029	\$3348	\$3741	
		<b>GC3631WFCA</b> Wood flex back	\$2277	\$2363	\$2436	\$2543	\$2691	\$2749	\$2881	\$3128	\$3253	\$3482	\$3801	\$4195
			<b>OVERALL DIMENSIONS</b>			<b>SEAT DIMENSIONS</b>			<b>BACK DIMENSIONS</b>					
			W	D	H	W	D	H	W	H				
25	27		36.5	20.5	17.5	18	20.5	18						
<p>Active weight 350 lbs. SSU armcap option - <b>Add \$96 list upcharge</b></p>														
<p><b>HB Armchair, Open Arms, Split Back (Wood)</b> COM Yardage: 2.25 Freight Class: 250 Product Weight (lbs.): 60 Cubic Feet Per Carton: 27.5</p>	<b>GC3632W</b> Wood	\$1786	\$1854	\$1915	\$2000	\$2124	\$2170	\$2276	\$2479	\$2581	\$2771	\$3031	\$3353	
		<b>GC3632WF</b> Wood flex back	\$2234	\$2305	\$2365	\$2451	\$2573	\$2620	\$2727	\$2930	\$3031	\$3219	\$3481	\$3804
			<b>OVERALL DIMENSIONS</b>			<b>SEAT DIMENSIONS</b>			<b>BACK DIMENSIONS</b>					
			W	D	H	W	D	H	W	H				
25	27		48.5	20.5	17.5	18	20.5	30						
<p>Active weight 350 lbs. Fold away headrest. SSU armcap option - <b>Add \$96 list upcharge</b></p>														





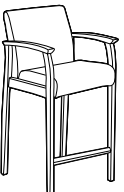

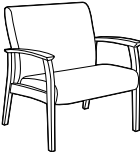

DESCRIPTION	MODEL#	STANDARD FABRIC GRADES											
		COM	2	3	4	5	6	7	8	9	10	11	12
 <p><b>HB Armchair, Closed Arms, Split Back (Wood)</b> COM Yardage: 3 Freight Class: 250 Product Weight (lbs.): 68 Cubic Feet Per Carton: 27.5</p> <p>Active weight 350 lbs. SSU armcap option - <b>Add \$96 list upcharge</b></p>	<b>GC3632WCA</b>	\$2006	\$2100	\$2180	\$2293	\$2459	\$2520	\$2665	\$2934	\$3069	\$3319	\$3668	\$4098
	Wood												
	<b>GC3632WFCA</b>	\$2469	\$2563	\$2643	\$2759	\$2922	\$2983	\$3127	\$3398	\$3532	\$3784	\$4132	\$4562
	Wood flex back												
		OVERALL DIMENSIONS			SEAT DIMENSIONS			BACK DIMENSIONS					
		W	D	H	W	D	H	W	H				
		25	27	48.5	20.5	17.5	18	20.5	30				

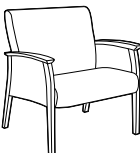
 <p>Designed to immobilize the pelvis and hip joints after surgery.</p> <p><b>LB Hip Armchair, Open Arms - Post Surgery (Wood)</b> COM Yardage: 1.5 Freight Class: 250 Product Weight (lbs.): 57 Cubic Feet Per Carton: 20</p> <p>Active weight 350 lbs. SSU armcap option - <b>Add \$96 list upcharge</b></p>	<b>GC3636W</b>	\$2219	\$2266	\$2307	\$2364	\$2447	\$2476	\$2548	\$2683	\$2751	\$2878	\$3052	\$3266
	Wood												
		OVERALL DIMENSIONS			SEAT DIMENSIONS			BACK DIMENSIONS					
		W	D	H	W	D	H	W	H				
		23	26	40.5	19	17.5	25.5	19	15.5				

 <p>Designed to immobilize the pelvis and hip joints after surgery.</p> <p><b>LB Hip Armchair, Closed Arms - Post Surgery (Wood)</b> COM Yardage: 2 Freight Class: 250 Product Weight (lbs.): 62 Cubic Feet Per Carton: 20</p> <p>Active weight 350 lbs. SSU armcap option - <b>Add \$96 list upcharge</b></p>	<b>GC3636WCA</b>	\$2447	\$2514	\$2573	\$2655	\$2776	\$2830	\$2940	\$3110	\$3242	\$3388	\$3692	\$4015
	Wood												
		OVERALL DIMENSIONS			SEAT DIMENSIONS			BACK DIMENSIONS					
		W	D	H	W	D	H	W	H				
		23	26	40.5	19	17.5	25.5	19	15.5				

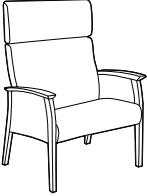
 <p><b>Bariatric MB Armchair, Open Arms (Wood)</b> COM Yardage: 2.75 Freight Class: 250 Product Weight (lbs.): 82 Cubic Feet Per Carton: 30.5</p> <p>Active weight 500 lbs. SSU armcap option - <b>Add \$96 list upcharge</b></p>	<b>GC3638W</b>	\$2038	\$2121	\$2294	\$2403	\$2552	\$2609	\$2741	\$2988	\$3112	\$3342	\$3662	\$4055
	Wood												
		OVERALL DIMENSIONS			SEAT DIMENSIONS			BACK DIMENSIONS					
		W	D	H	W	D	H	W	H				
		35	27	36.5	30	17.5	18	30	18				

 <p><b>Bariatric MB Armchair, Closed Arms (Wood)</b> COM Yardage: 3.75 Freight Class: 250 Product Weight (lbs.): 92 Cubic Feet Per Carton: 30.5</p> <p>Active weight 500 lbs. SSU armcap option - <b>Add \$96 list upcharge</b></p>	<b>GC3638WCA</b>	\$2251	\$2367	\$2465	\$2610	\$2815	\$2892	\$3071	\$3411	\$3579	\$3892	\$4326	\$4866
	Wood												
		OVERALL DIMENSIONS			SEAT DIMENSIONS			BACK DIMENSIONS					
		W	D	H	W	D	H	W	H				
		35	27	36.5	30	17.5	18	30	18				

DESCRIPTION	MODEL#	STANDARD FABRIC GRADES											
		COM	2	3	4	5	6	7	8	9	10	11	12
 <p><b>Bariatric HB Armchair, Open Arms, Split Back (Wood)</b>                      COM Yardage: 3.75                      Freight Class: 300                      Product Weight (lbs.): 65                      Cubic Feet Per Carton: 33</p>	<b>GC3639W</b>	\$2250	\$2367	\$2465	\$2610	\$2815	\$2892	\$3071	\$3411	\$3578	\$3892	\$4326	\$4864
	Wood												
		<b>OVERALL DIMENSIONS</b>			<b>SEAT DIMENSIONS</b>			<b>BACK DIMENSIONS</b>					
		W	D	H	W	D	H	W	H				
		35	27	48.5	30	17.5	18	30	30				
Active weight 500 lbs. Fold away headrest. SSU armcap option - <b>Add \$96 list upcharge</b>													
 <p><b>Bariatric HB Armchair, Closed Arms, Split Back (Wood)</b>                      COM Yardage: 4.75                      Freight Class: 250                      Product Weight (lbs.): 75                      Cubic Feet Per Carton: 33</p>	<b>GC3639WCA</b>	\$2492	\$2642	\$2768	\$2951	\$3210	\$3308	\$3535	\$3963	\$4175	\$4573	\$5125	\$5806
	Wood												
		<b>OVERALL DIMENSIONS</b>			<b>SEAT DIMENSIONS</b>			<b>BACK DIMENSIONS</b>					
		W	D	H	W	D	H	W	H				
		35	27	48.5	30	17.5	18	30	30				
Active weight 500 lbs. Fold away headrest. SSU armcap option - <b>Add \$96 list upcharge</b>													
 <p><b>HB Armchair, Open Arms (Wood)</b>                      COM Yardage: 2.5                      Freight Class: 250                      Product Weight (lbs.): 60                      Cubic Feet Per Carton: 27.5</p>	<b>GC3655W</b>	\$1667	\$1745	\$1812	\$1908	\$2044	\$2097	\$2215	\$2441	\$2553	\$2764	\$3051	\$3412
	Wood												
		<b>OVERALL DIMENSIONS</b>			<b>SEAT DIMENSIONS</b>			<b>BACK DIMENSIONS</b>					
		W	D	H	W	D	H	W	H				
		25	27	48.5	20.5	17.5	18	20.5	30				
Active weight 350 lbs. SSU armcap option - <b>Add \$96 list upcharge</b>													
 <p><b>HB Armchair, Closed Arms (Wood)</b>                      COM Yardage: 3.25                      Freight Class: 250                      Product Weight (lbs.): 68                      Cubic Feet Per Carton: 27.5</p>	<b>GC3655WCA</b>	\$1889	\$1990	\$2077	\$2204	\$2380	\$2446	\$2603	\$2893	\$3040	\$3312	\$3690	\$4157
	Wood												
		<b>OVERALL DIMENSIONS</b>			<b>SEAT DIMENSIONS</b>			<b>BACK DIMENSIONS</b>					
		W	D	H	W	D	H	W	H				
		25	27	48.5	20.5	17.5	18	20.5	30				
Active weight 350 lbs. SSU armcap option - <b>Add \$96 list upcharge</b>													
 <p><b>Bariatric HB Armchair, Open Arms (Wood)</b>                      COM Yardage: 3.5                      Freight Class: 250                      Product Weight (lbs.): 65                      Cubic Feet Per Carton: 30.75</p>	<b>GC3656W</b>	\$2094	\$2203	\$2295	\$2429	\$2621	\$2696	\$2862	\$3178	\$3333	\$3626	\$4032	\$4533
	Wood												
		<b>OVERALL DIMENSIONS</b>			<b>SEAT DIMENSIONS</b>			<b>BACK DIMENSIONS</b>					
		W	D	H	W	D	H	W	H				
		35	27	48.5	30	17.5	18	30	30				
Active weight 500 lbs. SSU armcap option - <b>Add \$96 list upcharge</b>													

DESCRIPTION	MODEL#	STANDARD FABRIC GRADES											
		COM	2	3	4	5	6	7	8	9	10	11	12
	<b>GC3656WCA</b>	<b>\$2326</b>	<b>\$2470</b>	<b>\$2586</b>	<b>\$2760</b>	<b>\$3005</b>	<b>\$3097</b>	<b>\$3313</b>	<b>\$3719</b>	<b>\$3921</b>	<b>\$4297</b>	<b>\$4818</b>	<b>\$5464</b>
	Wood												

OVERALL DIMENSIONS			SEAT DIMENSIONS			BACK DIMENSIONS	
W	D	H	W	D	H	W	H
35	27	48.5	30	17.5	18	30	30

**Bariatric HB Armchair, Closed Arms (Wood)**  
 COM Yardage: 4.5  
 Freight Class: 250  
 Product Weight (lbs.): 75  
 Cubic Feet Per Carton: 33

Active weight 500 lbs.  
 SSU armcap option - **Add \$96 list upcharge**

PRIMACARE LOUNGE



model GC3641 (HT)



model GC3641W (Wood)

STANDARD FEATURES

- Primacare is a family of products offering the most significant return on investment approach in the industry since every component can be repaired or replaced on site.
- **High traffic (HT) models:** Metal frame and self-skinned urethane (SSU) armcaps with die cast zinc connectors and metal-to-metal fasteners. Available in the following finishes: Black (BLK), Latte (LAB), Kalua (KAL), Mocha (J52), Shadow (SHW), Toast (TOA) and Tungsten (TUN).
- **Wood models:** Solid hardwood frame and armcaps with die cast zinc connectors and metal-to-metal fastening. Available in the following finishes: Absolute (AAM), Charcoal Java (CJM), Cherry (ACM), Empire Mahogany (EMM), English Oak (EOM), Espresso Cafe (ECM), Fruitwood (TFM), Gray (HGM), Harvest Oak (HOM), Honey (AHM), Jet Onyx (JOM), Light Honey (LHM), Mahogany (TMM), Maple (AVM), Medium Walnut (MWM), Night (ASM), Natural Walnut (NLW), Noce Biondo (NBM), Noce Grigio (NGM), Noce Leggero (NEM), Noce Medio (NMM), Sandy Beach (SBM), Shaker Cherry (SKM), Silver Oak (SOM), Walnut (TWM), White (WHM), WC Cream (WTM) and Winter Cherry (WCM).
- Armcaps are securely fastened with metal-to-metal connectors which allow for field replacement if required.
- Easy grip forward extending armcap on models with arms.
- Replaceable seat covers and replaceable and/or removable seat cushions are standard.
- Waterfall cleanout between the seat and back cushions.
- Models are standard with metal mesh seat deck. For behavioral health applications, the metal mesh seat deck can be covered with a solid moisture resistant surface, held in place with tamperproof fasteners. Contact your sales rep for a special quotation.
- All seat frames feature a wall saver design to prevent back contact with wall.
- Models ending in **CA** have upholstered panel arm inserts closing the arm. (Closed arm panels are designed to be replaceable. Request a special quote to have them secured with tamperproof fasteners.)
- For Globalcare textile options, visit the website at globalfurnituregroup.com.
- Can be upholstered in standard Global textiles if healthcare compliance is not required.
- It is recommended that High Traffic (HT) models be specified in textiles that meet or exceed 100,000 double rubs for added abrasion performance.
- Shipped fully assembled.
- **High traffic (HT) models are listed first, followed by wood models.**

OPTIONAL FEATURES

- **High traffic (HT) models:** Wood armcaps are available. See far left column "Wood models" for finishes. Please specify. No upcharge.
- **High traffic (HT) and wood models:** Self-skinned urethane (SSU) armcaps are available. Please specify. *Refer to individual models for availability and pricing.*
- For moisture barrier (seat only), add **\$178** list upcharge per seat. For bariatric models: GC3640, GC3640CA, GC3640W, and GC3640WCA - Add **\$183** list upcharge per seat.
- To add sealed seams to your product contact Customer Care. Upcharges vary.
- For Primacare tables, see page 56.

SUGGESTED APPLICATIONS

- Bariatric seating
- Guest seating
- Lobbies
- Lounge/Waiting
- Patient rooms
- Resident rooms

DESCRIPTION MODEL# / FEATURES STANDARD TEXTILE GRADES

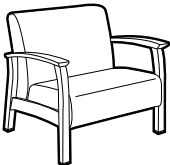

**Bariatric Lounge Chair, Open Arms (HT)**  
COM Yardage: 3.25  
Freight Class: 250  
Product Weight (lbs.): 109  
Cubic Feet Per Carton: 49.5

MODEL# / FEATURES	STANDARD TEXTILE GRADES											
	COM	2	3	4	5	6	7	8	9	10	11	12
<b>GC3640</b> Metal	\$3087	\$3191	\$3274	\$3400	\$3581	\$3647	\$3802	\$4091	\$4239	\$4511	\$4890	\$5353
	OVERALL DIMENSIONS			SEAT DIMENSIONS			BACK DIMENSIONS					
	W	D	H	W	D	H	W	H				
	40	32	33	36	20	17.25	36	16				

Active weight 500 lbs.  
SSU armcap option - **Add \$113 list upcharge**

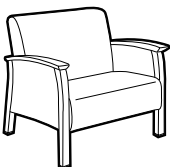

**Bariatric Lounge Chair, Closed Arms (HT)**  
COM Yardage: 5.75  
Freight Class: 250  
Product Weight (lbs.): 119  
Cubic Feet Per Carton: 49.5

MODEL# / FEATURES	STANDARD TEXTILE GRADES											
	COM	2	3	4	5	6	7	8	9	10	11	12
<b>GC3640CA</b> Metal	\$3322	\$3503	\$3655	\$3876	\$4190	\$4309	\$4582	\$5100	\$5360	\$5840	\$6509	\$7331
	OVERALL DIMENSIONS			SEAT DIMENSIONS			BACK DIMENSIONS					
	W	D	H	W	D	H	W	H				
	40	32	33	36	20	17.25	36	16				

Active weight 500 lbs.  
SSU armcap option - **Add \$113 list upcharge**

• For users up to 500 lbs.



**Lounge Chair, Open Arms (HT)**  
COM Yardage: 2.5  
Freight Class: 250  
Product Weight (lbs.): 78  
Cubic Feet Per Carton: 29.5

MODEL# / FEATURES	STANDARD TEXTILE GRADES											
	COM	2	3	4	5	6	7	8	9	10	11	12
<b>GC3641</b> Metal	\$2481	\$2560	\$2627	\$2723	\$2858	\$2910	\$3029	\$3254	\$3368	\$3576	\$3867	\$4227
	OVERALL DIMENSIONS			SEAT DIMENSIONS			BACK DIMENSIONS					
	W	D	H	W	D	H	W	H				
	29	32	33	23	20	17.25	22.5	16				

Active weight 500 lbs.  
SSU armcap option - **Add \$113 list upcharge**

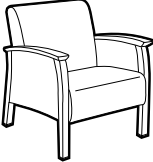
DESCRIPTION	MODEL#	STANDARD FABRIC GRADES											
		COM	2	3	4	5	6	7	8	9	10	11	12
 <p><b>Lounge Chair, Closed Arms (HT)</b> COM Yardage: 3.75 Freight Class: 250 Product Weight (lbs.): 91 Cubic Feet Per Carton: 29.5</p>	<b>GC3641CA</b>	\$2756	\$2872	\$2971	\$3115	\$3320	\$3397	\$3577	\$3916	\$4084	\$4397	\$4831	\$5371
	Metal												
			OVERALL DIMENSIONS			SEAT DIMENSIONS			BACK DIMENSIONS				
		W	D	H	W	D	H	W	H				
		29	32	33	23	20	17.25	22.5	16				

Active weight 500 lbs.  
SSU armcap option - Add \$113 list upcharge

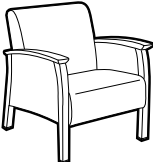
DESCRIPTION	MODEL#	STANDARD FABRIC GRADES											
		COM	2	3	4	5	6	7	8	9	10	11	12
 <p><b>Lounge Chair, Closed Arms, Laminate Panels (HT)</b> COM Yardage: 2.5 Freight Class: 250 Product Weight (lbs.): 91 Cubic Feet Per Carton: 29.5</p>	<b>GC3641CAL</b>	\$3088	\$3157	\$3217	\$3303	\$3425	\$3483	\$3594	\$3771	\$3907	\$4058	\$4371	\$4704
	Metal												
			OVERALL DIMENSIONS			SEAT DIMENSIONS			BACK DIMENSIONS				
		W	D	H	W	D	H	W	H				
		29	32	33	23	20	17.25	22.5	16				

Active weight 500 lbs.  
SSU armcap option - Add \$113 list upcharge

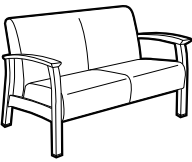
DESCRIPTION	MODEL#	STANDARD FABRIC GRADES											
		COM	2	3	4	5	6	7	8	9	10	11	12
 <p><b>Two Seat Sofa, Open Arms (HT)</b> COM Yardage: 4 Freight Class: 250 Product Weight (lbs.): 122 Cubic Feet Per Carton: 49.5</p>	<b>GC3642</b>	\$3577	\$3703	\$3808	\$3964	\$4180	\$4265	\$4455	\$4815	\$4997	\$5328	\$5794	\$6368
	Metal												
			OVERALL DIMENSIONS			SEAT DIMENSIONS			BACK DIMENSIONS				
		W	D	H	W	D	H	W	H				
		52	32	33	48	20	17.25	48	16				

Active weight 500 lbs./seat  
SSU armcap option - Add \$113 list upcharge

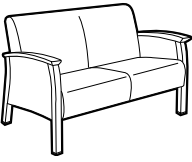
DESCRIPTION	MODEL#	STANDARD FABRIC GRADES											
		COM	2	3	4	5	6	7	8	9	10	11	12
 <p><b>Two Seat Sofa, Closed Arms (HT)</b> COM Yardage: 5.5 Freight Class: 250 Product Weight (lbs.): 132 Cubic Feet Per Carton: 49.5</p>	<b>GC3642CA</b>	\$3841	\$4016	\$4160	\$4373	\$4674	\$4786	\$5051	\$5543	\$5792	\$6251	\$6889	\$7678
	Metal												
			OVERALL DIMENSIONS			SEAT DIMENSIONS			BACK DIMENSIONS				
		W	D	H	W	D	H	W	H				
		52	32	33	48	20	17.25	48	16				

Active weight 500 lbs./seat  
SSU armcap option - Add \$113 list upcharge

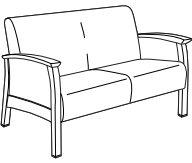
DESCRIPTION	MODEL#	STANDARD FABRIC GRADES											
		COM	2	3	4	5	6	7	8	9	10	11	12
 <p><b>Two Seat Sofa, Closed Arms, Laminate Panels (HT)</b> COM Yardage: 4 Freight Class: 250 Product Weight (lbs.): 132 Cubic Feet Per Carton: 49.5</p>	<b>GC3642CAL</b>	\$4179	\$4292	\$4387	\$4526	\$4720	\$4812	\$4990	\$5273	\$5490	\$5734	\$6233	\$6765
	Metal												
			OVERALL DIMENSIONS			SEAT DIMENSIONS			BACK DIMENSIONS				
		W	D	H	W	D	H	W	H				
		52	32	33	48	20	17.25	48	16				

Active weight 500 lbs./seat  
SSU armcap option - Add \$113 list upcharge

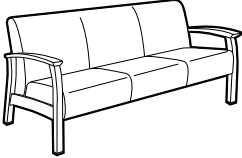
DESCRIPTION	MODEL#	STANDARD FABRIC GRADES											
		COM	2	3	4	5	6	7	8	9	10	11	12
 <p><b>Three Seat Sofa, Open Arms (HT)</b> COM Yardage: 6.25 Freight Class: 250 Product Weight (lbs.): 173 Cubic Feet Per Carton: 69.5</p>	<b>GC3643</b> Metal	\$5066	\$5264	\$5427	\$5666	\$6009	\$6137	\$6436	\$6999	\$7280	\$7801	\$8528	\$9424
		<b>OVERALL DIMENSIONS</b>			<b>SEAT DIMENSIONS</b>			<b>BACK DIMENSIONS</b>					
		<b>W</b>	<b>D</b>	<b>H</b>	<b>W</b>	<b>D</b>	<b>H</b>	<b>W</b>	<b>H</b>				
		75	32	33	71	20	17.25	71	16				

Active weight 500 lbs./seat  
SSU armcap option - **Add \$113 list upcharge**

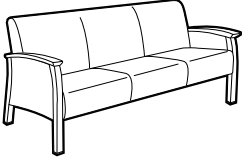
DESCRIPTION	MODEL#	STANDARD FABRIC GRADES											
		COM	2	3	4	5	6	7	8	9	10	11	12
 <p><b>Three Seat Sofa, Closed Arms (HT)</b> COM Yardage: 7.5 Freight Class: 250 Product Weight (lbs.): 183 Cubic Feet Per Carton: 69.5</p>	<b>GC3643CA</b> Metal	\$5339	\$5576	\$5773	\$6061	\$6469	\$6624	\$6983	\$7657	\$7995	\$8623	\$9492	\$10569
		<b>OVERALL DIMENSIONS</b>			<b>SEAT DIMENSIONS</b>			<b>BACK DIMENSIONS</b>					
		<b>W</b>	<b>D</b>	<b>H</b>	<b>W</b>	<b>D</b>	<b>H</b>	<b>W</b>	<b>H</b>				
		75	32	33	71	20	17.25	71	16				

Active weight 500 lbs./seat  
SSU armcap option - **Add \$113 list upcharge**

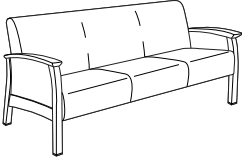
DESCRIPTION	MODEL#	STANDARD FABRIC GRADES											
		COM	2	3	4	5	6	7	8	9	10	11	12
 <p><b>Three Seat Sofa, Closed Arms, Laminate Panels (HT)</b> COM Yardage: 6.25 Freight Class: 250 Product Weight (lbs.): 183 Cubic Feet Per Carton: 69.5</p>	<b>GC3643CAL</b> Metal	\$5661	\$5840	\$5986	\$6202	\$6508	\$6652	\$6930	\$7371	\$7712	\$8091	\$8870	\$9703
		<b>OVERALL DIMENSIONS</b>			<b>SEAT DIMENSIONS</b>			<b>BACK DIMENSIONS</b>					
		<b>W</b>	<b>D</b>	<b>H</b>	<b>W</b>	<b>D</b>	<b>H</b>	<b>W</b>	<b>H</b>				
		75	32	33	71	20	17.25	71	16				

Active weight 500 lbs./seat  
SSU armcap option - **Add \$113 list upcharge**

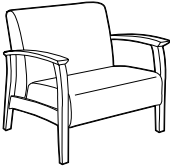
DESCRIPTION	MODEL#	STANDARD FABRIC GRADES											
		COM	2	3	4	5	6	7	8	9	10	11	12
 <p><b>Bariatric Lounge Chair, Open Arms (Wood)</b> COM Yardage: 3.25 Freight Class: 300 Product Weight (lbs.): 97 Cubic Feet Per Carton: 49.5</p>	<b>GC3640W</b> Wood	\$2540	\$2642	\$2728	\$2853	\$3032	\$3098	\$3254	\$3545	\$3690	\$3964	\$4340	\$4805
		<b>OVERALL DIMENSIONS</b>			<b>SEAT DIMENSIONS</b>			<b>BACK DIMENSIONS</b>					
		<b>W</b>	<b>D</b>	<b>H</b>	<b>W</b>	<b>D</b>	<b>H</b>	<b>W</b>	<b>H</b>				
		40	32	33	36	20	17.25	36	16				

Active weight 500 lbs.  
SSU armcap option - **Add \$113 list upcharge**

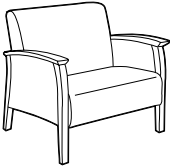
DESCRIPTION	MODEL#	STANDARD FABRIC GRADES											
		COM	2	3	4	5	6	7	8	9	10	11	12
 <p><b>Bariatric Lounge Chair, Closed Arms (Wood)</b> COM Yardage: 5.75 Freight Class: 250 Product Weight (lbs.): 107 Cubic Feet Per Carton: 49.5</p>	<b>GC3640WCA</b> Wood	\$2717	\$2901	\$3051	\$3272	\$3587	\$3705	\$3980	\$4497	\$4756	\$5237	\$5903	\$6728
		<b>OVERALL DIMENSIONS</b>			<b>SEAT DIMENSIONS</b>			<b>BACK DIMENSIONS</b>					
		<b>W</b>	<b>D</b>	<b>H</b>	<b>W</b>	<b>D</b>	<b>H</b>	<b>W</b>	<b>H</b>				
		40	32	33	36	20	17.25	36	16				

Active weight 500 lbs.  
SSU armcap option - **Add \$113 list upcharge**

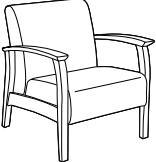
DESCRIPTION	MODEL#	STANDARD FABRIC GRADES																																			
		COM	2	3	4	5	6	7	8	9	10	11	12																								
 <p><b>Lounge Chair, Open Arms (Wood)</b> COM Yardage: 2.5 Freight Class: 250 Product Weight (lbs.): 66 Cubic Feet Per Carton: 29.5</p>	<b>GC3641W</b>	\$2038	\$2117	\$2184	\$2281	\$2416	\$2467	\$2587	\$2812	\$2925	\$3134	\$3424	\$3783																								
	Wood																																				
	<table border="1"> <thead> <tr> <th colspan="3">OVERALL DIMENSIONS</th> <th colspan="3">SEAT DIMENSIONS</th> <th colspan="3">BACK DIMENSIONS</th> </tr> <tr> <th>W</th> <th>D</th> <th>H</th> <th>W</th> <th>D</th> <th>H</th> <th>W</th> <th>H</th> </tr> </thead> <tbody> <tr> <td>29</td> <td>32</td> <td>33</td> <td>23</td> <td>20</td> <td>17.25</td> <td>22.5</td> <td>16</td> </tr> </tbody> </table>	OVERALL DIMENSIONS			SEAT DIMENSIONS			BACK DIMENSIONS			W	D	H	W	D	H	W	H	29	32	33	23	20	17.25	22.5	16											
OVERALL DIMENSIONS			SEAT DIMENSIONS			BACK DIMENSIONS																															
W	D	H	W	D	H	W	H																														
29	32	33	23	20	17.25	22.5	16																														

Active weight 350 lbs.  
SSU armcap option - Add \$113 list upcharge

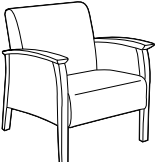
DESCRIPTION	MODEL#	STANDARD FABRIC GRADES																																			
		COM	2	3	4	5	6	7	8	9	10	11	12																								
 <p><b>Lounge Chair, Closed Arms (Wood)</b> COM Yardage: 3.75 Freight Class: 250 Product Weight (lbs.): 79 Cubic Feet Per Carton: 29.5</p>	<b>GC3641WCA</b>	\$2244	\$2361	\$2459	\$2605	\$2808	\$2886	\$3065	\$3402	\$3573	\$3885	\$4318	\$4857																								
	Wood																																				
	<table border="1"> <thead> <tr> <th colspan="3">OVERALL DIMENSIONS</th> <th colspan="3">SEAT DIMENSIONS</th> <th colspan="3">BACK DIMENSIONS</th> </tr> <tr> <th>W</th> <th>D</th> <th>H</th> <th>W</th> <th>D</th> <th>H</th> <th>W</th> <th>H</th> </tr> </thead> <tbody> <tr> <td>29</td> <td>32</td> <td>33</td> <td>23</td> <td>20</td> <td>17.25</td> <td>22.5</td> <td>16</td> </tr> </tbody> </table>	OVERALL DIMENSIONS			SEAT DIMENSIONS			BACK DIMENSIONS			W	D	H	W	D	H	W	H	29	32	33	23	20	17.25	22.5	16											
OVERALL DIMENSIONS			SEAT DIMENSIONS			BACK DIMENSIONS																															
W	D	H	W	D	H	W	H																														
29	32	33	23	20	17.25	22.5	16																														

Active weight 350 lbs.  
SSU armcap option - Add \$113 list upcharge

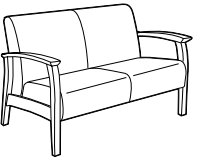
DESCRIPTION	MODEL#	STANDARD FABRIC GRADES																																			
		COM	2	3	4	5	6	7	8	9	10	11	12																								
 <p><b>Two Seat Sofa, Open Arms (Wood)</b> COM Yardage: 4 Freight Class: 250 Product Weight (lbs.): 110 Cubic Feet Per Carton: 49.5</p>	<b>GC3642W</b>	\$2941	\$3067	\$3173	\$3328	\$3544	\$3627	\$3819	\$4179	\$4360	\$4694	\$5155	\$5730																								
	Wood																																				
	<table border="1"> <thead> <tr> <th colspan="3">OVERALL DIMENSIONS</th> <th colspan="3">SEAT DIMENSIONS</th> <th colspan="3">BACK DIMENSIONS</th> </tr> <tr> <th>W</th> <th>D</th> <th>H</th> <th>W</th> <th>D</th> <th>H</th> <th>W</th> <th>H</th> </tr> </thead> <tbody> <tr> <td>52</td> <td>32</td> <td>33</td> <td>48</td> <td>20</td> <td>17.25</td> <td>48</td> <td>16</td> </tr> </tbody> </table>	OVERALL DIMENSIONS			SEAT DIMENSIONS			BACK DIMENSIONS			W	D	H	W	D	H	W	H	52	32	33	48	20	17.25	48	16											
OVERALL DIMENSIONS			SEAT DIMENSIONS			BACK DIMENSIONS																															
W	D	H	W	D	H	W	H																														
52	32	33	48	20	17.25	48	16																														

Active weight 350 lbs./seat  
SSU armcap option - Add \$113 list upcharge

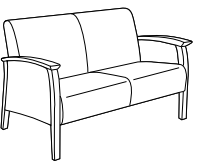
DESCRIPTION	MODEL#	STANDARD FABRIC GRADES																																			
		COM	2	3	4	5	6	7	8	9	10	11	12																								
 <p><b>Two Seat Sofa, Closed Arms (Wood)</b> COM Yardage: 5.5 Freight Class: 250 Product Weight (lbs.): 120 Cubic Feet Per Carton: 49.5</p>	<b>GC3642WCA</b>	\$3154	\$3326	\$3471	\$3683	\$3981	\$4095	\$4358	\$4853	\$5101	\$5560	\$6199	\$6987																								
	Wood																																				
	<table border="1"> <thead> <tr> <th colspan="3">OVERALL DIMENSIONS</th> <th colspan="3">SEAT DIMENSIONS</th> <th colspan="3">BACK DIMENSIONS</th> </tr> <tr> <th>W</th> <th>D</th> <th>H</th> <th>W</th> <th>D</th> <th>H</th> <th>W</th> <th>H</th> </tr> </thead> <tbody> <tr> <td>52</td> <td>32</td> <td>33</td> <td>48</td> <td>20</td> <td>17.25</td> <td>48</td> <td>16</td> </tr> </tbody> </table>	OVERALL DIMENSIONS			SEAT DIMENSIONS			BACK DIMENSIONS			W	D	H	W	D	H	W	H	52	32	33	48	20	17.25	48	16											
OVERALL DIMENSIONS			SEAT DIMENSIONS			BACK DIMENSIONS																															
W	D	H	W	D	H	W	H																														
52	32	33	48	20	17.25	48	16																														

Active weight 350 lbs./seat  
SSU armcap option - Add \$113 list upcharge

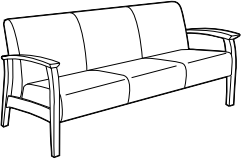
DESCRIPTION	MODEL#	STANDARD FABRIC GRADES																																			
		COM	2	3	4	5	6	7	8	9	10	11	12																								
 <p><b>Three Seat Sofa, Open Arms (Wood)</b> COM Yardage: 6.25 Freight Class: 250 Product Weight (lbs.): 161 Cubic Feet Per Carton: 69.5</p>	<b>GC3643W</b>	\$4163	\$4359	\$4525	\$4767	\$5106	\$5237	\$5534	\$6095	\$6379	\$6898	\$7625	\$8521																								
	Wood																																				
	<table border="1"> <thead> <tr> <th colspan="3">OVERALL DIMENSIONS</th> <th colspan="3">SEAT DIMENSIONS</th> <th colspan="3">BACK DIMENSIONS</th> </tr> <tr> <th>W</th> <th>D</th> <th>H</th> <th>W</th> <th>D</th> <th>H</th> <th>W</th> <th>H</th> </tr> </thead> <tbody> <tr> <td>75</td> <td>32</td> <td>33</td> <td>71</td> <td>20</td> <td>17.25</td> <td>71</td> <td>16</td> </tr> </tbody> </table>	OVERALL DIMENSIONS			SEAT DIMENSIONS			BACK DIMENSIONS			W	D	H	W	D	H	W	H	75	32	33	71	20	17.25	71	16											
OVERALL DIMENSIONS			SEAT DIMENSIONS			BACK DIMENSIONS																															
W	D	H	W	D	H	W	H																														
75	32	33	71	20	17.25	71	16																														

Active weight 350 lbs./seat  
SSU armcap option - Add \$113 list upcharge

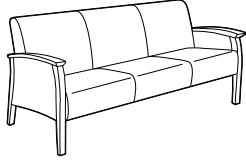
DESCRIPTION	MODEL#	STANDARD FABRIC GRADES											
		COM	2	3	4	5	6	7	8	9	10	11	12
	<b>GC3643WCA</b>	<b>\$4378</b>	<b>\$4618</b>	<b>\$4811</b>	<b>\$5103</b>	<b>\$5511</b>	<b>\$5666</b>	<b>\$6024</b>	<b>\$6699</b>	<b>\$7037</b>	<b>\$7663</b>	<b>\$8533</b>	<b>\$9609</b>
	Wood												

OVERALL DIMENSIONS			SEAT DIMENSIONS			BACK DIMENSIONS	
W	D	H	W	D	H	W	H
75	32	33	71	20	17.25	71	16

**Three Seat Sofa, Closed Arms (Wood)**

COM Yardage: 7.5  
 Freight Class: 250  
 Product Weight (lbs.): 171  
 Cubic Feet Per Carton: 69.5

Active weight 350 lbs./seat  
 SSU armcap option - **Add \$113 list upcharge**



PRIMACARE FULLY UPHOLSTERED LOUNGE



model GC3676HB



model GC3677

STANDARD FEATURES

- Primacare is a family of products offering the most significant return on investment approach in the industry since every component can be repaired or replaced on site.
- Standard with fully upholstered arms and Black self-skinned urethane (SSU) legs.
- Solid hardwood frame with die cast zinc connectors and metal-to-metal fastening.
- Replaceable seat covers and replaceable and/or removable seat cushions are standard.
- Waterfall cleanout between the seat and back cushions.
- Models are standard with metal mesh seat deck. For behavioral health applications, the metal mesh seat deck can be covered with a solid moisture resistant surface, held in place with tamperproof fasteners. Contact your sales rep for a special quotation.
- All seat frames feature a wall saver design to prevent back contact with wall.
- For Globalcare textile options, visit the website at www.globalfurnituregroup.com.
- Can be upholstered in standard Global textiles if healthcare compliance is not required.
- Shipped fully assembled.

OPTIONAL FEATURES

- Optional self-skinned urethane (SSU) armcaps available in the following finishes: Black (BLK), Latte (LAB), Kalua (KAL), Mocha (J52), Shadow (SHW), and Toast (TOA). Add \$410.
- Optional wood legs and armcaps available in the following finishes: Absolute (AAM), Charcoal Java (CJM), Cherry (ACM), Empire Mahogany (EMM), English Oak (EOM), Espresso Cafe (ECM), Fruitwood (TFM), Gray (HGM), Harvest Oak (HOM), Honey (AHM), Jet Onyx (JOM), Light Honey (LHM), Mahogany (TMM), Maple (AVM), Medium Walnut (MWM), Neutral Walnut (NLW), Night (ASM), Noce Biondo (NBM), Noce Grigio (NGM), Noce Leggero (NEM), Noce Medio (NMM), Sandy Beach (SBM), Silver Oak (SOM), Walnut (TWM), White (WHM), WC Cream (WTM) and Winter Cherry (WCM). See features column for upcharges.
- When specified with armcaps: armcaps are securely fastened with metal-to-metal connectors which allow for field replacement if required.
- For moisture barrier on seat, please specify **(MB)**. Add \$178 list upcharge per seat.
- To add sealed seams to your product contact Customer Care. Upcharges vary.
- For Primacare tables, see page 56

SUGGESTED APPLICATIONS

- Guest seating
- Patient rooms
- Lobbies
- Resident rooms
- Lounge/Waiting

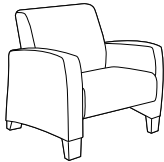
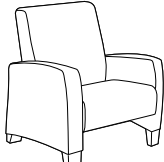
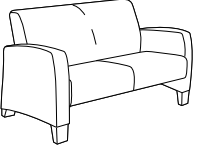
DESCRIPTION	MODEL# / FEATURES	STANDARD TEXTILE GRADES											
		COM	2	3	4	5	6	7	8	9	10	11	12
 <p><b>Lounge Chair, Fully Upholstered Arms, SSU legs</b> COM Yardage: 6.25 Freight Class: 250 Product Weight (lbs.): 95 Cubic Feet Per Carton: 29.5</p>	<b>GC3676</b>	\$2150	\$2350	\$2513	\$2753	\$3094	\$3224	\$3523	\$4085	\$4366	\$4888	\$5614	\$6511
	Active weight 350 lbs.	<b>OVERALL DIMENSIONS</b>			<b>SEAT DIMENSIONS</b>			<b>BACK DIMENSIONS</b>					
		<b>W</b>	<b>D</b>	<b>H</b>	<b>W</b>	<b>D</b>	<b>H</b>	<b>W</b>	<b>H</b>				
		32.5	29	33	23	20	17.25	23	16				
		Optional wood legs - no charge. SSU or wood armcap option - <b>Add \$410 list upcharge</b>											
 <p><b>HB Lounge Chair, Fully Upholstered Arms, SSU legs</b> COM Yardage: 6.5 Freight Class: 250 Product Weight (lbs.): 114 Cubic Feet Per Carton: 29.5</p>	<b>GC3676HB</b>	\$2205	\$2438	\$2630	\$2911	\$3309	\$3462	\$3810	\$4468	\$4796	\$5410	\$6258	\$7306
	Active weight 350 lbs.	<b>OVERALL DIMENSIONS</b>			<b>SEAT DIMENSIONS</b>			<b>BACK DIMENSIONS</b>					
		<b>W</b>	<b>D</b>	<b>H</b>	<b>W</b>	<b>D</b>	<b>H</b>	<b>W</b>	<b>H</b>				
		32.5	29	36	23	20	17.25	23	19				
		Optional wood legs - no charge. SSU or wood armcap option - <b>Add \$410 list upcharge</b>											
 <p><b>Two Seat Sofa, Fully Upholstered Arms, SSU legs</b> COM Yardage: 7.5 Freight Class: 250 Product Weight (lbs.): 135 Cubic Feet Per Carton: 56.25</p>	<b>GC3677</b>	\$3152	\$3389	\$3586	\$3873	\$4282	\$4439	\$4795	\$5469	\$5809	\$6434	\$7305	\$8381
	Active weight 350 lbs.	<b>OVERALL DIMENSIONS</b>			<b>SEAT DIMENSIONS</b>			<b>BACK DIMENSIONS</b>					
		<b>W</b>	<b>D</b>	<b>H</b>	<b>W</b>	<b>D</b>	<b>H</b>	<b>W</b>	<b>H</b>				
		55.5	29	33	45.5	20	17.25	45.5	16				
		Optional wood legs - no charge. SSU or wood armcap option - <b>Add \$410 list upcharge</b>											

# SEATING

# PRIMACARE™ FULLY UPHOLSTERED LOUNGE

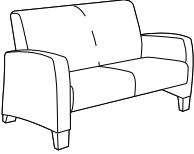
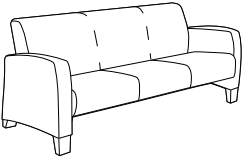
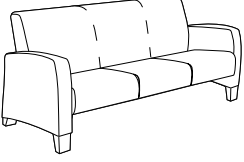
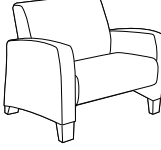
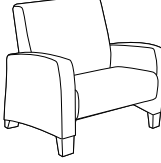
DESCRIPTION	MODEL#	STANDARD FABRIC GRADES											
		COM	2	3	4	5	6	7	8	9	10	11	12
 <p><b>HB Two Seat Sofa, Fully Upholstered Arms, SSU legs</b>                      COM Yardage: 7.75                      Freight Class: 250                      Product Weight (lbs.): 142                      Cubic Feet Per Carton: 56.25</p>	<b>GC3677HB</b>	\$3287	\$3566	\$3792	\$4130	\$4604	\$4784	\$5201	\$5986	\$6377	\$7107	\$8117	\$9369
	Active weight 350 lbs.	<b>OVERALL DIMENSIONS</b>			<b>SEAT DIMENSIONS</b>			<b>BACK DIMENSIONS</b>					
		<b>W</b>	<b>D</b>	<b>H</b>	<b>W</b>	<b>D</b>	<b>H</b>	<b>W</b>	<b>H</b>				
		55.5	29	36	45.5	20	17.25	45.5	19				
Optional wood legs - no charge. SSU or wood armcap option - <b>Add \$410 list upcharge</b>													
 <p><b>Three Seat Sofa, Fully Upholstered Arms, SSU legs</b>                      COM Yardage: 9                      Freight Class: 250                      Product Weight (lbs.): 181                      Cubic Feet Per Carton: 69.5</p>	<b>GC3678</b>	\$4366	\$4653	\$4888	\$5235	\$5725	\$5912	\$6342	\$7150	\$7555	\$8308	\$9351	\$10642
	Active weight 350 lbs.	<b>OVERALL DIMENSIONS</b>			<b>SEAT DIMENSIONS</b>			<b>BACK DIMENSIONS</b>					
		<b>W</b>	<b>D</b>	<b>H</b>	<b>W</b>	<b>D</b>	<b>H</b>	<b>W</b>	<b>H</b>				
		78.5	29	33	68.5	20	17.25	68.5	16				
Optional wood legs - no charge. SSU or wood armcap option - <b>Add \$410 list upcharge</b>													
 <p><b>HB Three Seat Sofa, Fully Upholstered Arms, SSU legs</b>                      COM Yardage: 9.25                      Freight Class: 250                      Product Weight (lbs.): 188                      Cubic Feet Per Carton: 69.5</p>	<b>GC3678HB</b>	\$4586	\$4918	\$5189	\$5589	\$6158	\$6373	\$6869	\$7805	\$8274	\$9144	\$10351	\$11843
	Active weight 350 lbs.	<b>OVERALL DIMENSIONS</b>			<b>SEAT DIMENSIONS</b>			<b>BACK DIMENSIONS</b>					
		<b>W</b>	<b>D</b>	<b>H</b>	<b>W</b>	<b>D</b>	<b>H</b>	<b>W</b>	<b>H</b>				
		78.5	29	36	68.5	20	17.25	68.5	19				
Optional wood legs - no charge. SSU or wood armcap option - <b>Add \$410 list upcharge</b>													
 <p><b>Bariatric Lounge Chair, Fully Upholstered Arms, SSU legs</b>                      COM Yardage: 6.5                      Freight Class: 250                      Product Weight (lbs.): 107                      Cubic Feet Per Carton: 37.75</p>	<b>GC3679</b>	\$2964	\$3171	\$3341	\$3592	\$3945	\$4081	\$4393	\$4975	\$5268	\$5811	\$6567	\$7496
	Active weight 500 lbs.	<b>OVERALL DIMENSIONS</b>			<b>SEAT DIMENSIONS</b>			<b>BACK DIMENSIONS</b>					
		<b>W</b>	<b>D</b>	<b>H</b>	<b>W</b>	<b>D</b>	<b>H</b>	<b>W</b>	<b>H</b>				
		42	29	33	32	20	17.25	32	16				
Optional wood legs - no charge. SSU or wood armcap option - <b>Add \$410 list upcharge</b>													
 <p><b>HB Bariatric Lounge Chair, Fully Upholstered Arms, SSU legs</b>                      COM Yardage: 6.75                      Freight Class: 250                      Product Weight (lbs.): 121                      Cubic Feet Per Carton: 37.75</p>	<b>GC3679HB</b>	\$3062	\$3304	\$3502	\$3794	\$4209	\$4367	\$4728	\$5412	\$5753	\$6388	\$7270	\$8356
	Active weight 500 lbs.	<b>OVERALL DIMENSIONS</b>			<b>SEAT DIMENSIONS</b>			<b>BACK DIMENSIONS</b>					
		<b>W</b>	<b>D</b>	<b>H</b>	<b>W</b>	<b>D</b>	<b>H</b>	<b>W</b>	<b>H</b>				
		42	29	36	32	20	17.25	32	19				
Optional wood legs - no charge. SSU or wood armcap option - <b>Add \$410 list upcharge</b>													

PRIMACARE WINGBACK



models GC3694HR and GC3696

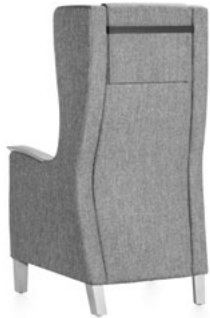

model GC3691HR

STANDARD FEATURES



- Primacare is a family of products offering the most significant return on investment approach in the industry since every component can be repaired or replaced on site.
- Standard with Black self-skinned urethane (SSU) legs and armcaps.
- Armcaps are securely fastened with metal-to-metal connectors which allow for field replacement if required.
- Easy grip forward extending armcap on models with arms.
- For added comfort, seat and back are standard with high density foam.
- Replaceable seat covers and replaceable and/or removable seat cushions are standard.
- Waterfall cleanout between the seat and back cushions.
- Models are standard with metal mesh seat deck. For mental health applications, the metal mesh seat deck can be covered with a solid moisture resistant surface, held in place with tamperproof fasteners. Contact your sales rep for a special quotation.
- Models GC3691HR, GC3692HR and GC3694HR are standard with headrest. The metal headrest retainer bar finish must be specified. Available in Toast (TOA), Mocha (J52), Shadow (SHW) and Black (BLK).
- For Globalcare textiles and finish options, visit the website at [www.globalfurnituregroup.com](http://www.globalfurnituregroup.com)
- Can be upholstered in standard Global textiles if healthcare compliance is not required.



OPTIONAL FEATURES

- Optional self-skinned urethane (SSU) legs and armcaps available in the following finishes: Latte (LAB), Kalua (KAL), (Mocha (J52), Shadow (SHW) and Toast (TOA). No upcharge.
- For optional wood legs and armcaps, refer to the Seating wood finishes in the Textiles + Finishes section.
- Additional headrest colors are available based on quantity. Please contact your Global representative for a special quotation.
- For moisture barrier on seat, please specify (MB). For single seater, add \$183. For two seater, add \$363. For bariatric models, add \$243.
- As an option, seams can be sealed to prevent penetration of fluids through the stitching. Please contact customer care for more information.
- For Primacare tables, see page 56

SUGGESTED APPLICATIONS

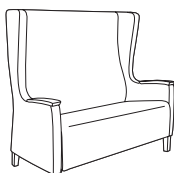
- Bariatric seating
- Guest seating
- Lobbies
- Patient rooms
- Lounge/Waiting
- Resident rooms

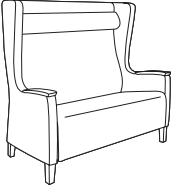
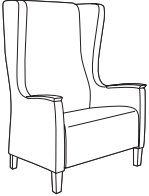
DESCRIPTION	MODEL# / FEATURES	STANDARD TEXTILE GRADES											
		COM	2	3	4	5	6	7	8	9	10	11	12
 <p>No headrest, cannot be retrofitted.</p> <p><b>Single Seater Wingback Armchair</b> COM Yardage: 7 Freight Class: 250 Product weight (lbs.): 98 Cubic Feet Per Carton: 32</p>	<b>GC3691</b>	\$3253	\$3474	\$3655	\$3923	\$4302	\$4484	\$4827	\$5376	\$5800	\$6271	\$7239	\$8272
	Active weight 350 lbs.	<b>OVERALL DIMENSIONS</b>			<b>SEAT DIMENSIONS</b>			<b>BACK DIMENSIONS</b>					
	Standard leg and armcap is Black SSU.	<b>W</b>	<b>D</b>	<b>H</b>	<b>W</b>	<b>D</b>	<b>H</b>	<b>W</b>	<b>H</b>				
	Optional SSU colors or wood legs/armcaps. No upcharge.	30.5	28.5	50.5	22.5	18	19	19	32				
 <p><b>Single Seater Wingback Armchair w/Headrest</b> COM Yardage: 7.5 Freight Class: 250 Product weight (lbs.): 98 Cubic Feet Per Carton: 32</p>	<b>GC3691HR</b>	\$3385	\$3621	\$3814	\$4104	\$4511	\$4700	\$5071	\$5660	\$6112	\$6618	\$7656	\$8765
	Active weight 350 lbs.	<b>OVERALL DIMENSIONS</b>			<b>SEAT DIMENSIONS</b>			<b>BACK DIMENSIONS</b>					
	Standard leg and armcap is Black SSU.	<b>W</b>	<b>D</b>	<b>H</b>	<b>W</b>	<b>D</b>	<b>H</b>	<b>W</b>	<b>H</b>				
	Optional SSU colors or wood legs/armcaps. No upcharge.	30.5	28.5	50.5	22.5	18	19	19	32				
 <p>No headrests, cannot be retrofitted.</p> <p><b>Two Seater Wingback Armchair</b> COM Yardage: 11 Freight Class: 250 Product weight (lbs.): 169 Cubic Feet Per Carton: 58</p>	<b>GC3692</b>	\$4473	\$4820	\$5104	\$5523	\$6122	\$6402	\$6945	\$7808	\$8474	\$9213	\$10737	\$12360
	Active weight 350 lbs./seat.	<b>OVERALL DIMENSIONS</b>			<b>SEAT DIMENSIONS</b>			<b>BACK DIMENSIONS</b>					
	Standard leg and armcap is Black SSU.	<b>W</b>	<b>D</b>	<b>H</b>	<b>W</b>	<b>D</b>	<b>H</b>	<b>W</b>	<b>H</b>				
	Optional SSU colors or wood legs/armcaps. No upcharge.	57.5	28.5	50.5	50	18	19	45	32				

DESCRIPTION	MODEL#	STANDARD FABRIC GRADES											
		COM	2	3	4	5	6	7	8	9	10	11	12
 <p><b>Two Seater Wingback Armchair w/Headrests</b>                      COM Yardage: 11.5                      Freight Class: 250                      Product weight (lbs.): 169                      Cubic Feet Per Carton: 58</p>	<b>GC3692HR</b>	\$4745	\$5109	\$5404	\$5845	\$6471	\$6764	\$7331	\$8234	\$8929	\$9701	\$11294	\$12992
	Active weight 350 lbs/seat.	<b>OVERALL DIMENSIONS</b>			<b>SEAT DIMENSIONS</b>			<b>BACK DIMENSIONS</b>					
	Standard leg and armcap is Black SSU.	<b>W</b>	<b>D</b>	<b>H</b>	<b>W</b>	<b>D</b>	<b>H</b>	<b>W</b>	<b>H</b>				
	Optional SSU colors or wood legs/armcaps. No upcharge.	57.5	28.5	50.5	50	18	19	45	32				
 <p>No headrest, cannot be retrofitted.</p> <p><b>Bariatric Single Seater Wingback Armchair</b>                      COM Yardage: 8.75                      Freight Class: 250                      Product weight (lbs.): 134                      Cubic Feet Per Carton: 39.25</p>	<b>GC3694</b>	\$3696	\$3973	\$4199	\$4533	\$5009	\$5232	\$5664	\$6350	\$6880	\$7467	\$8680	\$9971
	Active weight 500 lbs.	<b>OVERALL DIMENSIONS</b>			<b>SEAT DIMENSIONS</b>			<b>BACK DIMENSIONS</b>					
	Standard leg and armcap is Black SSU.	<b>W</b>	<b>D</b>	<b>H</b>	<b>W</b>	<b>D</b>	<b>H</b>	<b>W</b>	<b>H</b>				
	Optional SSU colors or wood legs/armcaps. No upcharge.	38	28.5	50.5	31	18	19	26.5	32				
 <p><b>Bariatric Single Seater Wingback Armchair w/Headrest</b>                      COM Yardage: 9.5                      Freight Class: 250                      Product weight (lbs.): 134                      Cubic Feet Per Carton: 39.25</p>	<b>GC3694HR</b>	\$3875	\$4176	\$4420	\$4786	\$5300	\$5543	\$6009	\$6758	\$7331	\$7969	\$9284	\$10687
	Active weight 500 lbs.	<b>OVERALL DIMENSIONS</b>			<b>SEAT DIMENSIONS</b>			<b>BACK DIMENSIONS</b>					
	Standard leg and armcap is Black SSU.	<b>W</b>	<b>D</b>	<b>H</b>	<b>W</b>	<b>D</b>	<b>H</b>	<b>W</b>	<b>H</b>				
	Optional SSU colors or wood legs/armcaps. No upcharge.	38	28.5	50.5	31	18	19	26.5	32				

PRIMACARE RECLINERS



model GC3608



model GC3609

STANDARD FEATURES

- Primacare is a family of products offering the most significant return on investment approach in the industry since every component can be repaired or replaced on site.
- Solid hardwood frame with die cast zinc connectors and metal-to-metal fastening. Available in the following finishes: Absolute (AAM), Charcoal Java (CJM), Cherry (ACM), Empire Mahogany (EMM), English Oak (EOM), Espresso Cafe (ECM), Fruitwood (TFM), Gray (HGM), Harvest Oak (HOM), Honey (AHM), Jet Onyx (JOM), Light Honey (LHM), Mahogany (TMM), Maple (AVM), Medium Walnut (MWM), Natural Walnut (NLW), Night (ASM), Noce Biondo (NBM), Noce Grigio (NGM), Noce Leggero (NEM), Noce Medio (NMM), Sandy Beach (SBM), Shaker Cherry (SKM), Silver Oak (SOM), Walnut (TWM), White (WHM), WC Cream (WTM) and Winter Cherry (WCM).
- Armcaps are securely fastened with metal-to-metal connectors which allow for field replacement if required.
- Easy grip forward extending armcap on models with arms.
- For Globalcare textile options, visit the website at [www.globalfurnituregroup.com](http://www.globalfurnituregroup.com).
- Can be upholstered in standard Global textiles if healthcare compliance is not required.
- Shipped easy to assemble.

OPTIONAL FEATURES

- Self-skinned urethane (SSU) armcaps are available in the following finishes: Black (BLK), Latte (LAB), Kalua (KAL), Mocha (J52), Shadow (SHW) and Toast (TOA). Please specify. Add \$239 list upcharge.
- For moisture barrier on seat, please specify **(MB)**. Add \$178 list upcharge per seat.
- For Primacare tables, see page 56

GC3608 AND GC3609 ONLY

- Tablet arm with spill collector on the edge is available, offered in Black Phenolic material. Tablet rotates so it can be positioned for any user activity and can fold down to store beside the chair when not being used. From seated position, specify **(LT)** for left hand tablet or **(RT)** for right hand tablet. Add \$964.
- Footrest in Grey thermally fused laminate with a Black edge is available. Specify **(FT)**. Add \$333.

SUGGESTED APPLICATIONS

- Guest seating
- Lobbies
- Lounge/Waiting
- Patient rooms
- Resident rooms
- Treatment/Exam rooms

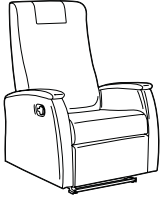
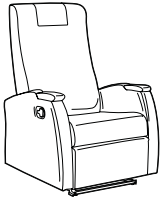
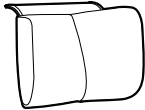
DESCRIPTION	MODEL# / FEATURES	STANDARD TEXTILE GRADES														
		COM	2	3	4	5	6	7	8	9	10	11	12			
 <p><b>Recliner, Solid Wood Armcaps, Full Span</b> COM Yardage: 6.5 Freight Class: 150 Product Weight (lbs.): 110 Cubic Feet Per Carton: 22.75</p>	GC3605	\$3001	\$3197	\$3520	\$3771	\$4124	\$4261	\$4570	\$5155	\$5448	\$5991	\$6743	\$7678			
	<b>OVERALL DIMENSIONS</b>		<b>SEAT DIMENSIONS</b>			<b>BACK DIMENSIONS</b>										
	W	D	H	W	D	H	W	H								
			29.5	34.5	45.5	21.5	20	17	21.5	28						
 <p><b>Recliner, Solid Wood Armcaps, Front Only</b> COM Yardage: 6.5 Freight Class: 150 Product Weight (lbs.): 110 Cubic Feet Per Carton: 22.75</p>	GC3606	\$2846	\$3042	\$3357	\$3609	\$3962	\$4097	\$4408	\$4992	\$5287	\$5828	\$6583	\$7516			
	<b>OVERALL DIMENSIONS</b>		<b>SEAT DIMENSIONS</b>			<b>BACK DIMENSIONS</b>										
	W	D	H	W	D	H	W	H								
			29.5	34.5	45.5	21.5	20	17	21.5	28						
 <p><b>Headrest for Primacare Recliners</b> COM Yardage: 1.25 Freight Class: 250 Product Weight (lbs.): 3 Cubic Feet Per Carton: 1</p>	GC3607	\$124	\$161	\$205	\$252	\$322	\$347	\$407	\$518	\$575	\$680	\$823	\$1003			
	<b>OVERALL DIMENSIONS</b>		<b>SEAT DIMENSIONS</b>			<b>BACK DIMENSIONS</b>										
	W	D	H	W	D	H	W	H								
			14	4	9.5											

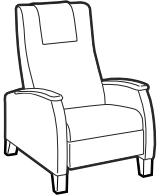
DESCRIPTION	MODEL#	STANDARD FABRIC GRADES											
		COM	2	3	4	5	6	7	8	9	10	11	12
 <p><b>Motion Recliner, Solid Wood Armcaps, Full Span</b>                      COM Yardage: 6.5                      Freight Class: 150                      Product Weight (lbs.): 120                      Cubic Feet Per Carton: 27.75</p>	<b>GC3608</b>	<b>\$3408</b>	<b>\$3604</b>	<b>\$3947</b>	<b>\$4198</b>	<b>\$4551</b>	<b>\$4685</b>	<b>\$4997</b>	<b>\$5580</b>	<b>\$5875</b>	<b>\$6417</b>	<b>\$7172</b>	<b>\$8102</b>
		<b>OVERALL DIMENSIONS</b> W D H			<b>SEAT DIMENSIONS</b> W D H			<b>BACK DIMENSIONS</b> W H					
		30	39	46.5	23.5	20	19	22.5	29				

Active weight 400 lbs.  
 SSU armcap option - **Add \$239 list upcharge**  
 Optional 4 manual locking casters w/push bar.  
 Specify **(MRC)** - no upcharge.

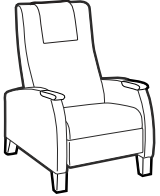
DESCRIPTION	MODEL#	STANDARD FABRIC GRADES											
		COM	2	3	4	5	6	7	8	9	10	11	12
 <p><b>Motion Recliner, Solid Wood Armcaps, Front Only</b>                      COM Yardage: 6.5                      Freight Class: 150                      Product Weight (lbs.): 120                      Cubic Feet Per Carton: 27.75</p>	<b>GC3609</b>	<b>\$3254</b>	<b>\$3450</b>	<b>\$3784</b>	<b>\$4036</b>	<b>\$4389</b>	<b>\$4523</b>	<b>\$4835</b>	<b>\$5418</b>	<b>\$5713</b>	<b>\$6256</b>	<b>\$7010</b>	<b>\$7944</b>
		<b>OVERALL DIMENSIONS</b> W D H			<b>SEAT DIMENSIONS</b> W D H			<b>BACK DIMENSIONS</b> W H					
		30	39	46.5	23.5	20	19	22.5	29				

Active weight 400 lbs.  
 Optional 4 manual locking casters w/push bar.  
 Specify **(MRC)** - no upcharge.

PRIMACARE SLEEPERS



model GC3611



model GC3611 (pulled out)

STANDARD FEATURES



- Primacare is a family of products offering the most significant return on investment approach in the industry since every component can be repaired or replaced on site.
- Solid hardwood frame with die cast zinc connectors and metal-to-metal fastening. Available in the following finishes: Absolute (AAM), Charcoal Java (CJM), Cherry (ACM), Empire Mahogany (EMM), English Oak (EOM), Espresso Cafe (ECM), Fruitwood (TFM), Gray (HGM), Harvest Oak (HOM), Honey (AHM), Jet Onyx (JOM), Light Honey (LHM), Mahogany (TMM), Maple (AVM), Medium Walnut (MWM), Natural Walnut (NLW), Night (ASM), Noce Biondo (NBM), Noce Grigio (NGM), Noce Leggero (NEM), Noce Medio (NMM), Sandy Beach (SBM), Shaker Cherry (SKM), Silver Oak (SOM), Walnut (TWM), White (WHM), WC Cream (WTM) and Winter Cherry (WCM).
- Armcaps are securely fastened with metal-to-metal connectors which allow for field replacement if required.
- Easy grip forward extending armcap on models with arms.
- For Globalcare textile options, visit the website at [www.globalfurnituregroup.com](http://www.globalfurnituregroup.com).
- Can be upholstered in standard Global textiles if healthcare compliance is not required.
- Shipped fully assembled.

OPTIONAL FEATURES

- Self-skinned urethane (SSU) armcaps are available in the following finishes: Black (BLK), Latte (LAB), Kalua (KAL), Mocha (J52), Shadow (SHW) and Toast (TOA). Please specify. Add \$239 list upcharge.
- For moisture barrier on seat, please specify **(MB)**. Add \$178 list upcharge per seat.
- For Primacare tables, see page 56

SUGGESTED APPLICATIONS

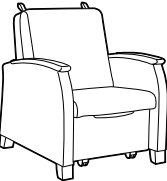
- Guest seating
- Lounge/Waiting
- Patient rooms
- Resident rooms
- Treatment/Exam rooms

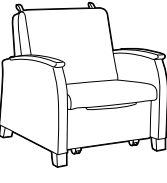
DESCRIPTION	MODEL# / FEATURES	STANDARD TEXTILE GRADES											
		COM	2	3	4	5	6	7	8	9	10	11	12
 <p><b>Single Sleeper Chair, Wood Legs</b> COM Yardage: 7.5 Freight Class: 250 Product Weight (lbs.): 116 Cubic Feet Per Carton: 32.25</p>	<b>GC3610</b>	\$3086	\$3325	\$3689	\$3993	\$4420	\$4583	\$4960	\$5669	\$6024	\$6684	\$7596	\$8724
		<b>OVERALL DIMENSIONS</b>			<b>SEAT DIMENSIONS</b>			<b>BACK DIMENSIONS</b>					
		<b>W</b>	<b>D</b>	<b>H</b>	<b>W</b>	<b>D</b>	<b>H</b>	<b>W</b>	<b>H</b>				
		31.5	37.5	38	24	20	18	24	21				
		Sleep surface is 24.5"W x 77"L Active weight 350 lbs. SSU armcap option - <b>Add \$239 list upcharge</b>											
 <p><b>Single Sleeper Chair, Casters</b> COM Yardage: 7.5 Freight Class: 250 Product Weight (lbs.): 116 Cubic Feet Per Carton: 32.25</p>	<b>GC3610C</b>	\$3086	\$3325	\$3689	\$3993	\$4420	\$4583	\$4960	\$5669	\$6024	\$6684	\$7596	\$8724
		<b>OVERALL DIMENSIONS</b>			<b>SEAT DIMENSIONS</b>			<b>BACK DIMENSIONS</b>					
		<b>W</b>	<b>D</b>	<b>H</b>	<b>W</b>	<b>D</b>	<b>H</b>	<b>W</b>	<b>H</b>				
		31.5	37.5	38	24	20	18	24	21				
		Sleep surface is 24.5"W x 77"L Active weight 350 lbs. SSU armcap option - <b>Add \$239 list upcharge</b>											
 <p><b>Single Sleeper Chair, Wide, Wood Legs</b> COM Yardage: 9 Freight Class: 250 Product Weight (lbs.): 140 Cubic Feet Per Carton: 36.75</p>	<b>GC3611</b>	\$3756	\$4029	\$4455	\$4802	\$5295	\$5481	\$5909	\$6719	\$7124	\$7878	\$8920	\$10214
		<b>OVERALL DIMENSIONS</b>			<b>SEAT DIMENSIONS</b>			<b>BACK DIMENSIONS</b>					
		<b>W</b>	<b>D</b>	<b>H</b>	<b>W</b>	<b>D</b>	<b>H</b>	<b>W</b>	<b>H</b>				
		37	37.5	38	30	20	18	30	21				
		Sleep surface is 30"W x 77"L Active weight 350 lbs. SSU armcap option - <b>Add \$239 list upcharge</b>											

DESCRIPTION	MODEL#	STANDARD FABRIC GRADES											
		COM	2	3	4	5	6	7	8	9	10	11	12
 <p><b>Single Sleeper Chair, Wide, Casters</b>                      COM Yardage: 9                      Freight Class: 250                      Product Weight (lbs.): 140                      Cubic Feet Per Carton: 36.75</p>	GC3611C	\$3756	\$4029	\$4455	\$4802	\$5295	\$5481	\$5909	\$6719	\$7124	\$7878	\$8920	\$10214
		<b>OVERALL DIMENSIONS</b>			<b>SEAT DIMENSIONS</b>			<b>BACK DIMENSIONS</b>					
		<b>W</b>	<b>D</b>	<b>H</b>	<b>W</b>	<b>D</b>	<b>H</b>	<b>W</b>	<b>H</b>				
		37	37.5	38	30	20	18	30	21				
 <p><b>Double Sleeper Chair, Wood Legs</b>                      COM Yardage: 11.75                      Freight Class: 250                      Product Weight (lbs.): 215                      Cubic Feet Per Carton: 60</p>	GC3612	\$4877	\$5234	\$5791	\$6245	\$6883	\$7127	\$7688	\$8743	\$9273	\$10255	\$11619	\$13303
		<b>OVERALL DIMENSIONS</b>			<b>SEAT DIMENSIONS</b>			<b>BACK DIMENSIONS</b>					
		<b>W</b>	<b>D</b>	<b>H</b>	<b>W</b>	<b>D</b>	<b>H</b>	<b>W</b>	<b>H</b>				
		56	36	38	48	19.5	18	48	21				
 <p><b>Double Sleeper Chair, Casters</b>                      COM Yardage: 11.75                      Freight Class: 250                      Product Weight (lbs.): 215                      Cubic Feet Per Carton: 60</p>	GC3612C	\$4877	\$5234	\$5791	\$6245	\$6883	\$7127	\$7688	\$8743	\$9273	\$10255	\$11619	\$13303
		<b>OVERALL DIMENSIONS</b>			<b>SEAT DIMENSIONS</b>			<b>BACK DIMENSIONS</b>					
		<b>W</b>	<b>D</b>	<b>H</b>	<b>W</b>	<b>D</b>	<b>H</b>	<b>W</b>	<b>H</b>				
		56	36	38	48	19.5	18	48	21				



PRIMACARE BENCHES



model GC3651 (HT)



model GC3652W (Wood)

STANDARD FEATURES

- Primacare is a family of products offering the most significant return on investment approach in the industry since every component can be repaired or replaced on site.
- **Wood models:** Solid hardwood frame with die cast zinc connectors and metal-to-metal fastening. Available in the following finishes: Absolute (AAM), Charcoal Java (CJM), Cherry (ACM), Empire Mahogany (EMM), English Oak (EOM), Espresso Cafe (ECM), Fruitwood (TFM), Gray (HGM), Harvest Oak (HOM), Honey (AHM), Jet Onyx (JOM), Light Honey (LHM), Mahogany (TMM), Maple (AVM), Medium Walnut (MWM), Natural Walnut (NLW), Night (ASM), Noce Biondo (NBM), Noce Grigio (NGM), Noce Leggero (NEM), Noce Medio (NMM), Sandy Beach (SBM), Shaker Cherry (SKM), Silver Oak (SOM), Walnut (TWM), White (WHM), WC Cream (WTM) and Winter Cherry (WCM).
- Replaceable and/or removable cushions are standard.

- For textile options, visit the website at [www.globalfurnituregroup.com](http://www.globalfurnituregroup.com).
- Can be upholstered in standard Global textiles if healthcare compliance is not required.
- It is recommended that High Traffic (HT) models be specified in textiles that meet or exceed 100,000 double rubs for added abrasion performance.
- Shipped fully assembled.
- **High traffic (HT) models are listed first, followed by wood models.**

OPTIONAL FEATURES

- For moisture barrier on seat, please specify **(MB)**. Add \$119 per seat.
- To add sealed seams to your product contact Customer Care. Upcharges vary.
- For Primacare tables, see page 56

SUGGESTED APPLICATIONS

- Guest seating
- Patient rooms
- Lounge/Waiting
- Resident rooms

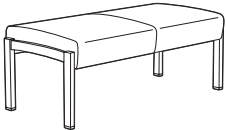
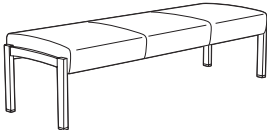
DESCRIPTION	MODEL# / FEATURES	STANDARD TEXTILE GRADES											
		COM	2	3	4	5	6	7	8	9	10	11	12
 <b>Single Seat Bench (HT)</b> COM Yardage: 1.25 Freight Class: 250 Product Weight (lbs.): 31 Cubic Feet Per Carton: 9.75	GC3651 Metal	\$1627	\$1668	\$1707	\$1758	\$1832	\$1868	\$1935	\$2042	\$2125	\$2217	\$2405	\$2608
	Active weight 350 lbs.	OVERALL DIMENSIONS			SEAT DIMENSIONS			BACK DIMENSIONS					
		W	D	H	W	D	H	W	H				
		26.5	22.5	19									
 <b>Two Seat Bench</b> COM Yardage: 2 Freight Class: 250 Product Weight (lbs.): 48 Cubic Feet Per Carton: 20.25	GC3652 Metal	\$2565	\$2632	\$2691	\$2773	\$2894	\$2948	\$3055	\$3227	\$3359	\$3506	\$3810	\$4132
	Active weight 350 lbs./seat	OVERALL DIMENSIONS			SEAT DIMENSIONS			BACK DIMENSIONS					
		W	D	H	W	D	H	W	H				
		49.5	22.5	19									
 <b>Three Seat Bench</b> COM Yardage: 2.75 Freight Class: 250 Product Weight (lbs.): 66 Cubic Feet Per Carton: 28.75	GC3653 Metal	\$3504	\$3597	\$3677	\$3790	\$3955	\$4032	\$4180	\$4416	\$4597	\$4801	\$5216	\$5660
	Active weight 350 lbs./seat	OVERALL DIMENSIONS			SEAT DIMENSIONS			BACK DIMENSIONS					
		W	D	H	W	D	H	W	H				
		72.5	22.5	19									

# SEATING

# PRIMACARE™ BENCHES

P

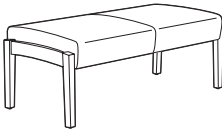
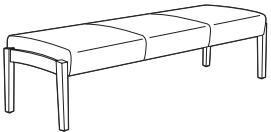
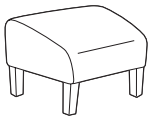
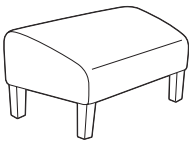
DESCRIPTION	MODEL#	STANDARD FABRIC GRADES											
		COM	2	3	4	5	6	7	8	9	10	11	12
 <b>Single Seat Bench (Wood)</b> COM Yardage: 1.25 Freight Class: 250 Product Weight (lbs.): 26 Cubic Feet Per Carton: 9.75	<b>GC3651W</b> Wood  Active weight 350 lbs./seat	\$1399	\$1438	\$1477	\$1528	\$1603	\$1638	\$1705	\$1813	\$1895	\$1987	\$2177	\$2378
		OVERALL DIMENSIONS			SEAT DIMENSIONS			BACK DIMENSIONS					
		W	D	H	W	D	H	W	H				
			26.5	22.5	19								
 <b>Two Seat Bench (Wood)</b> COM Yardage: 2 Freight Class: 250 Product Weight (lbs.): 41 Cubic Feet Per Carton: 20.25	<b>GC3652W</b> Wood  Active weight 350 lbs./seat	\$2237	\$2302	\$2362	\$2446	\$2564	\$2619	\$2728	\$2898	\$3030	\$3179	\$3481	\$3803
		OVERALL DIMENSIONS			SEAT DIMENSIONS			BACK DIMENSIONS					
		W	D	H	W	D	H	W	H				
			49.5	22.5	19								
 <b>Three Seat Bench (Wood)</b> COM Yardage: 2.75 Freight Class: 250 Product Weight (lbs.): 61 Cubic Feet Per Carton: 28.75	<b>GC3653W</b> Wood  Active weight 350 lbs./seat	\$3070	\$3164	\$3244	\$3360	\$3523	\$3599	\$3749	\$3983	\$4165	\$4367	\$4784	\$5226
		OVERALL DIMENSIONS			SEAT DIMENSIONS			BACK DIMENSIONS					
		W	D	H	W	D	H	W	H				
			72.5	22.5	19								
 <b>Standard Size Ottoman</b> COM Yardage: 1.25 Freight Class: 250 Product weight (lbs.): 17 Cubic Feet Per Carton: 4.7	<b>GC3695</b>  Active weight 350 lbs.  Standard leg is Black SSU.  Optional SSU colors or wood legs. No upcharge.	\$812	\$849	\$884	\$932	\$1001	\$1032	\$1094	\$1192	\$1268	\$1352	\$1525	\$1710
		OVERALL DIMENSIONS			SEAT DIMENSIONS			BACK DIMENSIONS					
		W	D	H	W	D	H	W	H				
			23	18	15.75	-	-	-	-	-			
 <b>Bariatric Ottoman</b> COM Yardage: 1.75 Freight Class: 250 Product Weight (lbs.): 20 Cubic Feet Per Carton: 9	<b>GC3696</b>  Active weight 500 lbs.  Standard leg is Black SSU.  Optional SSU colors or wood legs. No upcharge.	\$1025	\$1079	\$1125	\$1194	\$1288	\$1334	\$1419	\$1555	\$1664	\$1781	\$2023	\$2280
		OVERALL DIMENSIONS			SEAT DIMENSIONS			BACK DIMENSIONS					
		W	D	H	W	D	H	W	H				
			31.25	18	15.75	-	-	-	-	-			

## PRIMACARE MODULAR



## STANDARD FEATURES

- Modular seating tops: Linking applications are available for medium and high back patient top units, low back guest top units and lounge top units.
- All modular seating top units are complete with frame and cushions. Leg/arm frames are ordered separately according to the desired specification.
- Frame design features a wall saver leg to prevent damage to walls. Frame construction ensures metal-to-metal fastening.
- For leg/arm frames and modular tables with power/USB module, refer to models ending in "M". Module includes two power outlets, four USB charging ports and a 6 foot long power cord. Available in Black or White (must be specified at time of order).
- Replaceable and/or removable seat and back cushions with replaceable cushion covers are standard.
- Seat cushion has a seamless waterfall front and clean out between and around the seat and back cushions.
- All (CA) models have closed upholstered arm panel inserts at each arm position.
- For added comfort, seats are standard with high density foam.
- Active weight capacity up to 500 lbs/seat when using metal frame, fully upholstered frame or on bariatric models; up to 350 lbs/seat when using wood frame.
- For textile options, visit the website at [www.globalfurnituregroup.com](http://www.globalfurnituregroup.com).
- Can be upholstered in standard Global textiles if healthcare compliance is not required.
- Left and right position reference is determined from the seated position.

## SUGGESTED APPLICATIONS

- Bariatric seating
- Guest seating
- Lobbies
- Lounge/Waiting

## OPTIONAL FEATURES

- Self-skinned urethane (SSU) finishes are available on armcaps and on models with SSU legs in the following: Black (BLK), Latte (LAB), Kalua (KAL), Mocha (J52), Shadow (SHW) and Toast (TOA). Refer to individual models for availability and pricing.
- Metal leg/arm frames are available in the following finishes: Black (BLK), Latte (LAB), Kalua (KAL), Mocha (J52), Shadow (SHW), Toast (TOA) and Tungsten (TUN). Please specify.
- Wood legs and armcaps available in the following finishes: Absolute (AAM), Charcoal Java (CJM), Cherry (ACM), Empire Mahogany (EMM), English Oak (EOM), Espresso Cafe (ECM), Fruitwood (TFM), Gray (HGM), Harvest Oak (HOM), Honey (AHM), Jet Onyx (JOM), Light Honey (LHM), Mahogany (TMM), Maple (AVM), Medium Walnut (MWM), Natural Walnut (NLW), Night (ASM), Noce Biondo (NBM), Noce Grigio (NGM), Noce Leggero (NEM), Noce Medio (NMM), Sandy Beach (SBM), Shaker Cherry (SKM), Silver Oak (SOM), Walnut (TWM), White (WHM), WC Cream (WTM) and Winter Cherry (WCM). Refer to individual models for availability and pricing.
- Armcaps are securely fastened with metal-to-metal connectors which allows for field replacement if required. *Armcaps cannot be retrofitted in the field on units with no existing armcaps.*
- For moisture barrier on seat, please specify (MB). Add \$119 per seat. For bariatric/lounge models, - Add \$183 per seat.
- To add sealed seams to your product contact Customer Care. Upcharges vary.

For Primacare freestanding tables, see page 56

For Primacare Modular tables, see page 199

For Primacare Modular lounge tables, see page 210

## MODULAR TABLES

Modular tables are offered with wood or metal legs. 1" thick table tops are available in thermally fused laminate (LP) and high pressure laminate (HP). Please select the appropriate model number for the finish you prefer.

**Note:** Modular tables are shipped KD (knock down) as per the published cube and weight. For Primacare freestanding tables, see page 56.

## Thermally fused laminate (LP):

Absolute Acajou (ACJ)	Noce Biondo (NBL)
Asian Night (ASN)	Noce Grigio (NGL)
Avant Cherry (AWC)	Noce Leggero (NEL)
Avant Honey (AWH)	Noce Medio (NML)
Brushed Cobalt (BRC)	Quartered Mahogany (QTM)
Clear Maple (CMB)	Tiger Fruitwood (TFW)
Dark Espresso (DES)	Tiger Walnut (TWL)
Designer White (DWT)	Walnut Heights (WHE)
Hayden Grey (HGT)	White Chocolate (WHC)
	Winter Cherry (WCR)

## High pressure laminate (HP):

Absolute Acajou (ACJ)	Noce Grigio (NGL)
Asian Night (ASN)	Noce Leggero (NEL)
Avant Cherry (W357)	Noce Medio (NML)
Avant Honey (W356)	Quartered Mahogany (QTM)
Brushed Cobalt (BRC)	Tiger Fruitwood (TFW)
Clear Maple (CMB)	Tiger Walnut (W819)
Dark Espresso (W142)	Walnut Heights (WHE)
Designer White (DWT)	White Chocolate (WHC)
Hayden Grey (HGT)	Winter Cherry (WCR)
Noce Biondo (NBL)	

## Metal leg and frame finishes:

Available in Black (BLK), Latte (LAB), Kalua (KAL), Mocha (J52), Shadow (SHW), Toast (TOA) and Tungsten (TUN). Please specify.

## SHIPPING INFORMATION:

Product components and parts will be shipped knocked down (KD). Weight and volume are indicated with each item KD. They will not be shipped assembled.

## Assembled with drawing:

Product orders that are part of a linked application may require a combination of complete units and components for build up to achieve the limitless configurations that are possible. CAD drawing must be submitted with order when requesting units ship assembled.

Globalcare will provide assembled units under the following conditions:

1. Detailed drawing clearly indicating:
  - The layout and location of each model number being ordered (see sample following).
  - If multiple textiles are used - textile color codes must be clearly identified on drawing.
2. Globalcare will carton assemble orders to a maximum of 3 regular seat positions, which is the largest carton available.
3. Globalcare reserves the right to determine the best method of assembly based on the information provided with the order.

PACKAGE 1 - Primacare HT

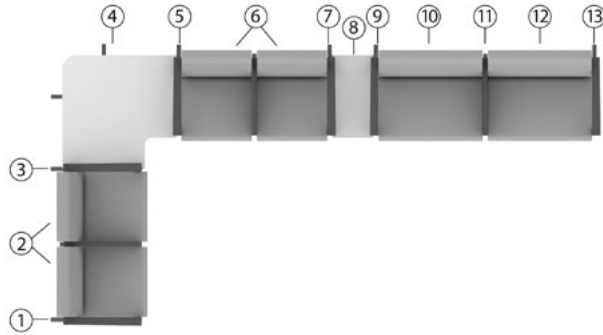

Always call out components as if seated in the chairs.

Item	Description	Qty.	Model #	Dimensions (D x W x H)	Ydg.	Frts. Class	Wt. Lbs.	Cu. Ft.	List Price	Ext. Price
1	Right End Frame with Right Armcap	1	GC3620RA	27 x 2.5 x 26.5	--	125	10	1.4	\$544	\$544
2, 6	Guest Low Back Two Seat Top w/Half Center Arm	2	GC3623TOP	25 x 42 x 19	3.25	300	68	43	\$2541	\$5082
3, 7	Seat to Table Center Linking Frame w/Left Armcap	2	GC3622TLA	27 x 2.5 x 26.5	--	125	10	1.4	\$593	\$1186
4	Right Corner Table	1	GC3671R-HP	33 x 33 x 17	--	125	45	6	\$1391	\$1391
5, 9	Seat to Table Center Linking Frame w/Right Armcap	2	GC3622TRA	27 x 2.5 x 26.5	--	125	10	1.4	\$593	\$1186
8	Narrow Center Table	1	GC3673-HP	23.87 x 12 x 5.5	--	100	18	2.1	\$760	\$760
10, 12	Bariatric Top, Guest Low Back	2	GC3637TOP	25 x 30 x 19	2.5	250	53	26.5	\$1601	\$3202
11	Seat to Seat Center Linking Frame w/Narrow Armcap	1	GC3622LA	27 x 2.5 x 26.5	--	125	10	1.4	\$607	\$607
13	Left End Frame with Left Armcap	1	GC3620LA	27 x 2.5 x 26.5	--	125	10	1.4	\$544	\$544

PACKAGE TOTAL

\$14,502

(\*Please Note: List Prices shown are for the standard Grade 2 vinyl/standard finishes.)

PACKAGE 2 - Primacare HT

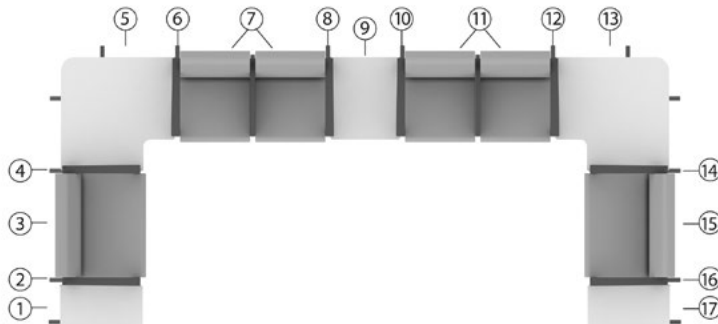

Always call out components as if seated in the chairs.

Item	Description	Qty.	Model #	Dimensions (D x W x H)	Ydg.	Frts. Class	Wt. Lbs.	Cu. Ft.	List Price	Ext. Price
1	Narrow Right End Table	1	GC3675R-HP	23.87 x 12 x 17	--	100	18	2.1	\$1136	\$1136
2, 6, 10, 14	Seat to Table Center Linking Frame w/Right Armcap	4	GC3622TRA	27 x 2.5 x 26.5	--	125	10	1.4	\$593	\$2372
3, 15	Guest Low Back Bariatric Top	2	GC3637TOP	25 x 30 x 19	2.5	250	53	26.5	\$1601	\$3202
4, 8, 12, 16	Seat to Table Center Linking Frame w/Left Armcap	4	GC3622TLA	27 x 2.5 x 26.5	--	125	10	1.4	\$593	\$2372
5	Right Corner Table	1	GC3671R-HP	33 x 33 x 17	--	125	45	6	\$1391	\$1391
7, 11	Guest Low Back Two Seat Top w/Half Center Arm	2	GC3623TOP	25 x 42 x 19	3.25	300	68	43	\$2541	\$5082
9	Regular Center Table	1	GC3672-HP	23.87 x 20.25 x 5.5	--	150	20	3.4	\$782	\$782
13	Left Corner Table	1	GC3671L-HP	33 x 33 x 17	--	100	54	6	\$1391	\$1391
17	Narrow Left End Table	1	GC3675L-HP	23.87 x 12 x 17	--	100	18	2.1	\$1136	\$1136

PACKAGE TOTAL

\$18,864

(\*Please Note: List Prices shown are for the standard Grade 2 vinyl/standard finishes.)

PACKAGE 3 - Primacare Wood

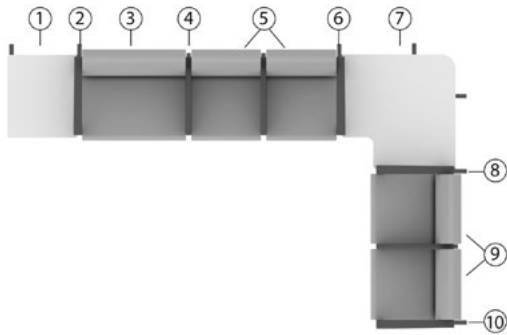

Always call out components as if seated in the chairs.

Item	Description	Qty.	Model #	Dimensions (D x W x H)	Ydg.	Frts. Class	Wt. Lbs.	Cu. Ft.	List Price	Ext. Price
1	Right End Run Table	1	GC3674WR-LP	23.87 x 20.25 x 17	--	150	19	3.4	\$1042	\$1042
2, 8	Seat to Table Center Linking Frame w/Right Armcap	2	GC3622WTRA	27 x 2.5 x 26.5	--	150	8	1.4	\$437	\$874
3	Guest Low Back Bariatric Top	1	GC3637TOP	25 x 30 x 19	2.5	250	53	26.5	\$1601	\$1601
4	Seat to Seat Center Linking Frame w/Narrow Armcap	1	GC3622WLA	27 x 2.5 x 26.5	--	150	8	1.4	\$403	\$403
5, 9	Guest Low Back Two Seat Top w/Half Center Arm	2	GC3623WTOP	25 x 42 x 19	3.25	300	68	43	\$2260	\$4520
6	Seat to Table Center Linking Frame w/Left Armcap	1	GC3622WTLA	27 x 2.5 x 26.5	--	150	8	1.4	\$437	\$437
7	Left Corner Table	1	GC3671WL-HP	33 x 33 x 17	--	100	54	6	\$1317	\$1317
10	Left End Frame w/Left Armcap	1	GC3620WLA	23 x 2 x 26	--	125	10	1.4	\$389	\$389

**PACKAGE TOTAL**

**\$10,583**

(\*Please Note: List Prices shown are for the standard Grade 2 vinyl/standard finishes.)

MODULAR TOP UNITS	SINGLE SEAT		SINGLE SEAT		TWO SEATER, NO CENTER ARM	TWO SEATER, CENTER ARM		THREE SEATER, NO CENTER ARMS	THREE SEATER, TWO ARMS	
	medium back	bariatric	medium back	bariatric	medium back	medium back	high back	medium back	medium back	high back
<b>Guest seating</b>	GC3620TOP 	GC3637TOP 	GC3655TOP 	GC3656TOP 	GC3621TOP 	GC3623TOP GC3623WTOP 	GC3623HB-TOP GC3623WHB-TOP 	GC3624TOP 	GC3626TOP GC3626WTOP 	GC3626HB-TOP GC3626WHB-TOP 
<b>Patient seating</b>	GC3631TOP 	GC3638TOP 	GC3655TOP 	GC3656TOP 		GC3623CATOP GC3623WCATOP 	GC3623HBCA-TOP GC3623WHBCA-TOP 		GC3626CATOP GC3626WCATOP 	GC3626HBCA-TOP GC3626WHBCA-TOP 

## LEG / ARM FRAMES

**Wood frame: Must select armcap**  
**Metal frame: Standard with Black SSU armcap (see notes for wood and SSU finish options)**

	LEFT, OPEN		RIGHT, OPEN		LEFT, CLOSED		RIGHT, CLOSED		LEFT, CLOSED LAMINATE PANEL	RIGHT, CLOSED LAMINATE PANEL
<b>Metal (HT) End</b>	GC3620LA 	GC3620LAM 	GC3620RA 	GC3620RAM 	GC3620LCA 	GC3620LCAM 	GC3620RCA 	GC3620RCAM 	GC3620LCAL 	GC3620RCAL 
<b>Wood End</b>	GC3620WLA 	GC3620WLAM 	GC3620WRA 	GC3620WRAM 	GC3620WLCA 	GC3620WLCAM 	GC3620WRCA 	GC3620WRCAM 		
<b>Metal (HT) Center</b>	GC3622LA 				GC3622LCA 				GC3622LCAL 	
<b>Wood Center</b>	GC3622WLA 				GC3622WLCA 					
<b>Metal (HT) Center table linking</b>	GC3622TLA 		GC3622TRA 		GC3622TLCA 		GC3622TRCA 		GC3622TLCAL 	GC3622TRCAL 
<b>Wood Center table linking</b>	GC3622WTLA 		GC3622WTRA 		GC3622WTLCA 		GC3622WTRCA 			

For frame with power/USB module\*, refer to models ending in "M"

### End Frame: Armless

	LEFT	RIGHT
<b>Metal End</b>	GC3620LNA 	GC3620RNA 
<b>Wood End</b>	GC3620WLNA 	GC3620WRNA 

### Central Linking Frame: Armless

	CENTER
<b>Metal</b>	GC3622LNA 
<b>Wood</b>	GC3622WLNA 

(Center = link both sides)

\*Power module includes two power outlets, four USB charging ports and a 6 foot long power cord. Available in Black or White (must be specified at time of order). Power module is mounted on the frame below seat support rail.

**MODULAR TABLES**

Tables include legs to support table top (except for center tables). All tables have a metal frame.

LEFT

RIGHT

**Corner**  
(laminated top with metal legs)

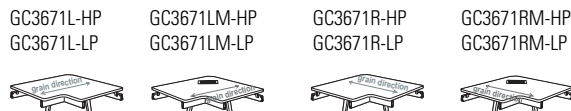

**Corner**  
(laminated top with wood legs)



**Center**  
(laminated top, connects to metal or wood frame)



For table with power/USB module\*, refer to models ending in "M"

**Narrow Center**  
(laminated top, connects to metal or wood frame)

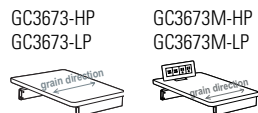

**End**  
(laminated top with metal legs)

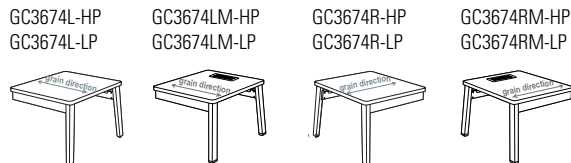

**End**  
(laminated top with wood legs)

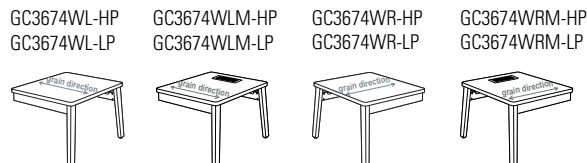

**Narrow End**  
(laminated top with metal legs)

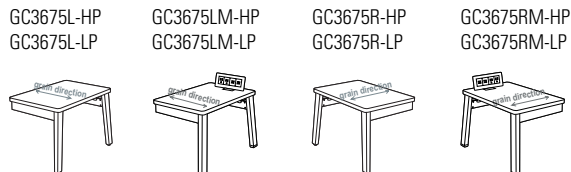

**Narrow End**  
(laminated top with wood legs)

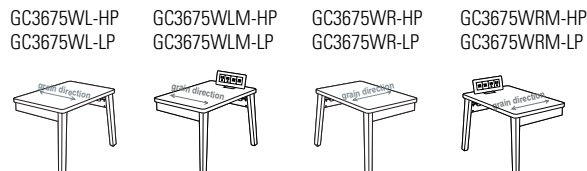

\*Power module includes two power outlets, four USB charging ports and a 6 foot long power cord. Available in Black or White (must be specified at time of order). Power module is mounted **on surface** on narrow tables; mounted **in surface** on larger tables (as shown above).

# SEATING

# PRIMACARE™ MODULAR - GUEST/PATIENT

P

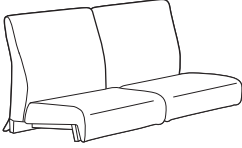
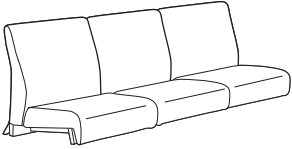
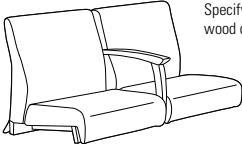
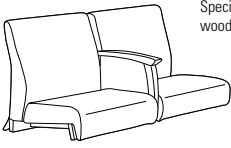
DESCRIPTION	MODEL#	STANDARD FABRIC GRADES											
		COM	2	3	4	5	6	7	8	9	10	11	12
  <b>LB Guest Single Seat Top</b> COM Yardage: 1.75 Freight Class: 250 Product Weight (lbs.): 36 Cubic Feet Per Carton: 10	<b>GC3620TOP</b>	\$952	\$1006	\$1052	\$1120	\$1215	\$1251	\$1336	\$1494	\$1573	\$1719	\$1922	\$2172
		<b>OVERALL DIMENSIONS</b> W    D    H			<b>SEAT DIMENSIONS</b> W    D    H			<b>BACK DIMENSIONS</b> W    H					
		20.5	25	19	20.5	17.5	--	20.5	15				
Single frame guest top unit with 1 low back cushion and 1 seat cushion. <b>Must be connected to a full arm/leg frame.</b>													
  <b>LB Guest Two Seat Top, No Center Arm</b> COM Yardage: 3.25 Freight Class: 300 Product Weight (lbs.): 72 Cubic Feet Per Carton: 43	<b>GC3621TOP</b>	\$2111	\$2213	\$2299	\$2424	\$2603	\$2670	\$2824	\$3116	\$3262	\$3534	\$3913	\$4376
		<b>OVERALL DIMENSIONS</b> W    D    H			<b>SEAT DIMENSIONS</b> W    D    H			<b>BACK DIMENSIONS</b> W    H					
		40	25	19	40	17.5	--	40	15				
Double frame guest top unit with 2 low back cushions and 2 seat cushions. <b>Must be connected to a full arm/leg frame.</b>													
  <b>LB Guest Three Seat Top, No Center Arm</b> COM Yardage: 4.25 Freight Class: 300 Product Weight (lbs.): 82 Cubic Feet Per Carton: 65.25	<b>GC3624TOP</b>	\$3213	\$3347	\$3457	\$3621	\$3853	\$3941	\$4144	\$4525	\$4718	\$5073	\$5567	\$6175
		<b>OVERALL DIMENSIONS</b> W    D    H			<b>SEAT DIMENSIONS</b> W    D    H			<b>BACK DIMENSIONS</b> W    H					
		60	25	19	60	17.5	--	60	15				
Triple frame guest top unit with 3 low back cushions and 3 seat cushions. <b>Must be connected to a full arm/leg frame.</b>													
 Specify armcap: wood or SSU.	<b>GC3623TOP</b>	\$2438	\$2541	\$2627	\$2755	\$2931	\$2997	\$3153	\$3446	\$3590	\$3862	\$4241	\$4705
	<b>GC3623WTOP</b>	\$2157	\$2260	\$2345	\$2471	\$2650	\$2717	\$2872	\$3163	\$3309	\$3581	\$3960	\$4424
		<b>OVERALL DIMENSIONS</b> W    D    H			<b>SEAT DIMENSIONS</b> W    D    H			<b>BACK DIMENSIONS</b> W    H					
	42	25	19	20.5	17.5	--	20.5	15					
Double low back frame guest top, 2 back and 2 seat cushions. SSU armcap option - <b>Add \$49 list upcharge</b> <b>Must be connected to a full arm/leg frame.</b>													
 Specify armcap: wood or SSU.	<b>GC3623CATOP</b>	\$2570	\$2681	\$2773	\$2907	\$3098	\$3172	\$3340	\$3654	\$3811	\$4104	\$4510	\$5011
	<b>GC3623WCATOP</b>	\$2268	\$2379	\$2471	\$2604	\$2797	\$2869	\$3037	\$3352	\$3508	\$3802	\$4207	\$4708
		<b>OVERALL DIMENSIONS</b> W    D    H			<b>SEAT DIMENSIONS</b> W    D    H			<b>BACK DIMENSIONS</b> W    H					
	42	25	19	20.5	17.5	--	20.5	15					
Double low back frame guest top, 2 back and 2 seat cushions. SSU armcap option - <b>Add \$49 list upcharge</b> <b>Must be connected to a full arm/leg frame.</b>													

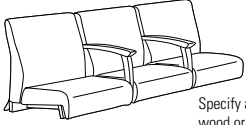

DESCRIPTION	MODEL#	STANDARD FABRIC GRADES											
		COM	2	3	4	5	6	7	8	9	10	11	12
 <p>Specify armcap: wood or SSU.</p>	<b>GC3626TOP</b>	\$3871	\$4021	\$4146	\$4330	\$4588	\$4687	\$4913	\$5341	\$5554	\$5951	\$6504	\$7185
	Metal												
	<b>GC3626WTOP</b>	\$3346	\$3497	\$3622	\$3806	\$4064	\$4162	\$4388	\$4815	\$5029	\$5427	\$5979	\$6659
	Wood												

**LB Guest Three Seat Top, Open Center Arms**  
 COM Yardage: 4.75  
 Freight Class: 300  
 Product Weight (lbs.): 77  
 Cubic Feet Per Carton: 65.25

Triple low back frame guest top, 3 back and 3 seat cushions.  
 Due to the size and weight, this top requires at least 3 installers.  
 SSU armcap option - **Add \$96 list upcharge**  
**Must be connected to a full arm/leg frame.**

OVERALL DIMENSIONS			SEAT DIMENSIONS			BACK DIMENSIONS	
W	D	H	W	D	H	W	H
64	25	19	20.5	17.5	--	20.5	15



**LB Guest Three Seat Top, Closed Center Arms**  
 COM Yardage: 5.5  
 Freight Class: 300  
 Product Weight (lbs.): 83  
 Cubic Feet Per Carton: 65.25

Triple low back frame guest top, 3 back and 3 seat cushions.  
 Due to the size and weight, this top requires at least 3 installers.  
 SSU armcap option - **Add \$96 list upcharge**  
**Must be connected to a full arm/leg frame.**

STANDARD FABRIC GRADES												
COM	2	3	4	5	6	7	8	9	10	11	12	
<b>GC3626CATOP</b>	\$4132	\$4307	\$4451	\$4664	\$4962	\$5076	\$5339	\$5834	\$6082	\$6541	\$7180	\$7968
Metal												
<b>GC3626WCATOP</b>	\$3557	\$3732	\$3876	\$4089	\$4390	\$4502	\$4764	\$5259	\$5507	\$5967	\$6606	\$7394
Wood												

OVERALL DIMENSIONS			SEAT DIMENSIONS			BACK DIMENSIONS	
W	D	H	W	D	H	W	H
64	25	19	20.5	17.5	--	20.5	15

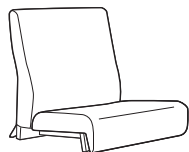

**MB Patient Top**  
 COM Yardage: 1.75  
 Freight Class: 150  
 Product Weight (lbs.): 42  
 Cubic Feet Per Carton: 10

Single mid back frame patient top, with 1 back and 1 seat cushion.  
**Must be connected to a full arm/leg frame.**

STANDARD FABRIC GRADES												
COM	2	3	4	5	6	7	8	9	10	11	12	
<b>GC3631TOP</b>	\$1005	\$1059	\$1105	\$1172	\$1269	\$1304	\$1387	\$1546	\$1624	\$1772	\$1974	\$2224

OVERALL DIMENSIONS			SEAT DIMENSIONS			BACK DIMENSIONS	
W	D	H	W	D	H	W	H
20.5	25	22	20.5	17.5	--	20.5	18

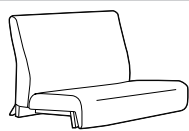

**LB Bariatric Guest Top**  
 COM Yardage: 2.5  
 Freight Class: 250  
 Product Weight (lbs.): 53  
 Cubic Feet Per Carton: 26.5

Single low back frame bariatric guest top, with 1 back and 1 seat cushion.  
**Must be connected to a full arm/leg frame.**

STANDARD FABRIC GRADES												
COM	2	3	4	5	6	7	8	9	10	11	12	
<b>GC3637TOP</b>	\$1523	\$1601	\$1667	\$1765	\$1900	\$1953	\$2073	\$2297	\$2409	\$2618	\$2907	\$3267

OVERALL DIMENSIONS			SEAT DIMENSIONS			BACK DIMENSIONS	
W	D	H	W	D	H	W	H
30	25	19	30	17.5	--	30	15

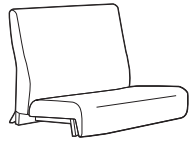

**MB Bariatric Patient Top**  
 COM Yardage: 2.75  
 Freight Class: 250  
 Product Weight (lbs.): 62  
 Cubic Feet Per Carton: 30.5

Single mid back frame bariatric patient top, with 1 back and 1 seat cushion.  
**Must be connected to a full arm/leg frame.**

STANDARD FABRIC GRADES												
COM	2	3	4	5	6	7	8	9	10	11	12	
<b>GC3638TOP</b>	\$1624	\$1710	\$1783	\$1888	\$2038	\$2096	\$2228	\$2475	\$2599	\$2828	\$3148	\$3542

OVERALL DIMENSIONS			SEAT DIMENSIONS			BACK DIMENSIONS	
W	D	H	W	D	H	W	H
30	25	22	30	17.5	--	30	18

# SEATING

# PRIMACARE™ MODULAR - GUEST/PATIENT

P

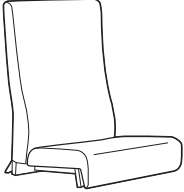
DESCRIPTION	MODEL#	STANDARD FABRIC GRADES											
		COM	2	3	4	5	6	7	8	9	10	11	12
 <p><b>HB Patient Top</b> COM Yardage: 2.5 Freight Class: 250 Product Weight (lbs.): 52 Cubic Feet Per Carton: 13.25</p>	<b>GC3655TOP</b>	\$1086	\$1165	\$1232	\$1328	\$1464	\$1515	\$1635	\$1860	\$1973	\$2182	\$2471	\$2832
	<b>OVERALL DIMENSIONS</b>			<b>SEAT DIMENSIONS</b>			<b>BACK DIMENSIONS</b>						
	<b>W</b>	<b>D</b>	<b>H</b>	<b>W</b>	<b>D</b>	<b>H</b>	<b>W</b>	<b>H</b>					
	20.5	25	34	20.5	17.5	--	20.5	30					
<p>Single high back frame patient top with 1 back and 1 seat cushion.</p> <p><b>Must be connected to a full arm/leg frame.</b></p>													

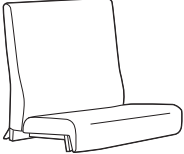
DESCRIPTION	MODEL#	STANDARD FABRIC GRADES											
		COM	2	3	4	5	6	7	8	9	10	11	12
 <p><b>HB Bariatric Patient Top</b> COM Yardage: 3.5 Freight Class: 300 Product Weight (lbs.): 62 Cubic Feet Per Carton: 33</p>	<b>GC3656TOP</b>	\$1703	\$1814	\$1906	\$2040	\$2231	\$2304	\$2473	\$2787	\$2943	\$3236	\$3643	\$4144
	<b>OVERALL DIMENSIONS</b>			<b>SEAT DIMENSIONS</b>			<b>BACK DIMENSIONS</b>						
	<b>W</b>	<b>D</b>	<b>H</b>	<b>W</b>	<b>D</b>	<b>H</b>	<b>W</b>	<b>H</b>					
	30	25	34	30	17.5	--	30	30					
<p>Single high back frame bariatric patient top with 1 back and 1 seat cushion.</p> <p><b>Must be connected to a full arm/leg frame.</b></p>													

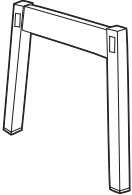
DESCRIPTION	MODEL#	STANDARD FABRIC GRADES												
		COM	2	3	4	5	6	7	8	9	10	11	12	
 <p><b>Left End Frame, Armless</b> COM Yardage: -- Freight Class: 150 Product Weight (lbs.): 5 Cubic Feet Per Carton: 1.2</p>		List Price												
	<b>GC3620LNA</b>		\$452											
	Metal													
<b>GC3620WLNA</b>		\$241												
Wood														
<b>OVERALL DIMENSIONS</b>			<b>SEAT DIMENSIONS</b>			<b>BACK DIMENSIONS</b>								
<b>W</b>	<b>D</b>	<b>H</b>	<b>W</b>	<b>D</b>	<b>H</b>	<b>W</b>	<b>H</b>							
	1.25	24.25	16											
<p>For use in <b>left</b> side finished position of guest and/or patient seating units.</p> <p><b>Does not allow linking to other units or tables.</b></p>														

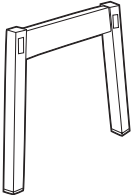
DESCRIPTION	MODEL#	STANDARD FABRIC GRADES												
		COM	2	3	4	5	6	7	8	9	10	11	12	
 <p><b>Right End Frame, Armless</b> COM Yardage: -- Freight Class: 150 Product Weight (lbs.): 5 Cubic Feet Per Carton: 1.2</p>		List Price												
	<b>GC3620RNA</b>		\$452											
	Metal													
<b>GC3620WRNA</b>		\$241												
Wood														
<b>OVERALL DIMENSIONS</b>			<b>SEAT DIMENSIONS</b>			<b>BACK DIMENSIONS</b>								
<b>W</b>	<b>D</b>	<b>H</b>	<b>W</b>	<b>D</b>	<b>H</b>	<b>W</b>	<b>H</b>							
	1.25	24.25	16											
<p>For use in <b>right</b> side finished position of guest and/or patient seating units.</p> <p><b>Does not allow linking to other units or tables.</b></p>														

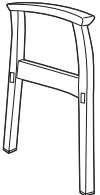
DESCRIPTION	MODEL#	STANDARD FABRIC GRADES												
		COM	2	3	4	5	6	7	8	9	10	11	12	
 <p><b>Left End Frame, Open Arm</b> COM Yardage: -- Freight Class: 125 Product Weight (lbs.): 10 Cubic Feet Per Carton: 1.4</p>		List Price												
	<b>GC3620LA</b>		\$544											
	<b>GC3620LAM</b> (w/power)		\$1762											
<b>GC3620WLA</b>		\$389												
<b>GC3620WLAM</b> (w/power)		\$1579												
Specify armcap: wood or SSU.														
<b>OVERALL DIMENSIONS</b>			<b>SEAT DIMENSIONS</b>			<b>BACK DIMENSIONS</b>								
<b>W</b>	<b>D</b>	<b>H</b>	<b>W</b>	<b>D</b>	<b>H</b>	<b>W</b>	<b>H</b>							
	2.5	27	26.5											
<p>For use in <b>left</b> side finished position of guest and/or patient seating units.</p> <ul style="list-style-type: none"> <li>Models GC3620LAM and GC3620WLAM have <b>power/USB</b> module (not shown).</li> </ul> <p><b>Does not allow linking to other units or tables.</b> SSU armcap option - <b>Add \$49 list upcharge</b></p>														

DESCRIPTION

MODEL#

STANDARD FABRIC GRADES

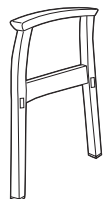

**Right End Frame, Open Arm**  
 COM Yardage: --  
 Freight Class: 125  
 Product Weight (lbs.): 10  
 Cubic Feet Per Carton: 1.4

List Price	
<b>GC3620RA</b> (Metal)	<b>\$544</b>
<b>GC3620RAM</b> (w/power)	<b>\$1762</b>
<b>GC3620WRA</b> (Wood)	<b>\$389</b>
<b>GC3620WRAM</b> (w/power)	<b>\$1579</b>

Specify armcap:  
wood or SSU.

OVERALL DIMENSIONS			SEAT DIMENSIONS			BACK DIMENSIONS	
W	D	H	W	D	H	W	H
2.5	27	26.5					

For use in **right** side finished position of guest and/or patient seating units.  
 • Models GC3620RAM and GC3620WRAM have **power/USB** module (not shown).  
**Does not allow linking to other units or tables.**  
 SSU armcap option - **Add \$49 list upcharge**

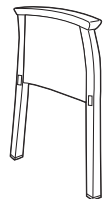

**Left End Frame, Closed Arm**  
 COM Yardage: 0.65  
 Freight Class: 92.5  
 Product Weight (lbs.): 15  
 Cubic Feet Per Carton: 1.4

COM	2	3	4	5	6	7	8	9	10	11	12	
<b>GC3620LCA</b> (Metal)	<b>\$669</b>	<b>\$689</b>	<b>\$708</b>	<b>\$733</b>	<b>\$768</b>	<b>\$783</b>	<b>\$811</b>	<b>\$872</b>	<b>\$900</b>	<b>\$956</b>	<b>\$1032</b>	<b>\$1032</b>
<b>GC3620LCAM</b> (w/power)	<b>\$1908</b>	<b>\$1927</b>	<b>\$1946</b>	<b>\$1971</b>	<b>\$2007</b>	<b>\$2023</b>	<b>\$2056</b>	<b>\$2108</b>	<b>\$2146</b>	<b>\$2190</b>	<b>\$2280</b>	<b>\$2377</b>
<b>GC3620WLCA</b> (Wood)	<b>\$488</b>	<b>\$507</b>	<b>\$526</b>	<b>\$551</b>	<b>\$587</b>	<b>\$602</b>	<b>\$630</b>	<b>\$690</b>	<b>\$721</b>	<b>\$774</b>	<b>\$850</b>	<b>\$942</b>
<b>GC3620WLCAM</b> (w/power)	<b>\$1698</b>	<b>\$1717</b>	<b>\$1738</b>	<b>\$1761</b>	<b>\$1797</b>	<b>\$1814</b>	<b>\$1848</b>	<b>\$1899</b>	<b>\$1937</b>	<b>\$1980</b>	<b>\$2073</b>	<b>\$2170</b>

Specify armcap:  
wood or SSU.

OVERALL DIMENSIONS			SEAT DIMENSIONS			BACK DIMENSIONS	
W	D	H	W	D	H	W	H
2.5	27	26.5					

For use in **left** side finished position of guest and/or patient seating units.  
 • Models GC3620LCAM and GC3620WLCAM have **power/USB** module (not shown).  
**Does not allow linking to other units or tables.**  
 SSU armcap option - **Add \$49 list upcharge**

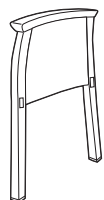

**Right End Frame, Closed Arm**  
 COM Yardage: 0.65  
 Freight Class: 92.5  
 Product Weight (lbs.): 15  
 Cubic Feet Per Carton: 1.4

COM	2	3	4	5	6	7	8	9	10	11	12	
<b>GC3620RCA</b> (metal)	<b>\$669</b>	<b>\$689</b>	<b>\$708</b>	<b>\$733</b>	<b>\$768</b>	<b>\$783</b>	<b>\$811</b>	<b>\$872</b>	<b>\$900</b>	<b>\$956</b>	<b>\$1032</b>	<b>\$1124</b>
<b>GC3620RCAM</b> (w/power)	<b>\$1908</b>	<b>\$1927</b>	<b>\$1946</b>	<b>\$1971</b>	<b>\$2007</b>	<b>\$2023</b>	<b>\$2056</b>	<b>\$2108</b>	<b>\$2146</b>	<b>\$2190</b>	<b>\$2280</b>	<b>\$2377</b>
<b>GC3620WRCA</b> (wood)	<b>\$488</b>	<b>\$507</b>	<b>\$526</b>	<b>\$551</b>	<b>\$587</b>	<b>\$602</b>	<b>\$630</b>	<b>\$690</b>	<b>\$721</b>	<b>\$774</b>	<b>\$850</b>	<b>\$942</b>
<b>GC3620WRCAM</b> (w/power)	<b>\$1698</b>	<b>\$1717</b>	<b>\$1738</b>	<b>\$1761</b>	<b>\$1797</b>	<b>\$1814</b>	<b>\$1848</b>	<b>\$1899</b>	<b>\$1937</b>	<b>\$1980</b>	<b>\$2073</b>	<b>\$2170</b>

Specify armcap:  
wood or SSU.

OVERALL DIMENSIONS			SEAT DIMENSIONS			BACK DIMENSIONS	
W	D	H	W	D	H	W	H
2.5	27	26.5					

For use in **right** side finished position of guest and/or patient seating units.  
 • Models GC3620RCAM and GC3620WRCAM have **power/USB** module (not shown).  
**Does not allow linking to other units or tables.**  
 SSU armcap option - **Add \$49 list upcharge**

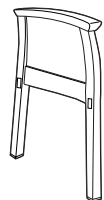

**Left End Frame, Closed Arm, Laminate Panel**  
 COM Yardage: --  
 Freight Class: 85  
 Product Weight (lbs.): 18  
 Cubic Feet Per Carton: 1.4

List Price	
<b>GC3620LCAL</b>	<b>\$885</b>

Metal

Specify armcap:  
wood or SSU.

OVERALL DIMENSIONS			SEAT DIMENSIONS			BACK DIMENSIONS	
W	D	H	W	D	H	W	H
2.5	27	26.5					

For use in **left** side finished position of guest and/or patient seating units.  
**Does not allow linking to other units or tables.**  
 SSU armcap option - **Add \$49 list upcharge**

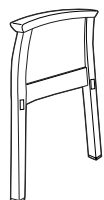

**Right End Frame, Closed Arm, Laminate Panel**  
 COM Yardage: --  
 Freight Class: 85  
 Product Weight (lbs.): 18  
 Cubic Feet Per Carton: 1.4

List Price	
<b>GC3620RCAL</b>	<b>\$885</b>

Metal

Specify armcap:  
wood or SSU.

OVERALL DIMENSIONS			SEAT DIMENSIONS			BACK DIMENSIONS	
W	D	H	W	D	H	W	H
2.5	27	26.5					

For use in **left** side finished position of guest and/or patient seating units.  
**Does not allow linking to other units or tables.**  
 SSU armcap option - **Add \$49 list upcharge**

# SEATING

# PRIMACARE™ MODULAR - GUEST/PATIENT

P

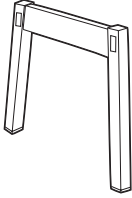
DESCRIPTION	MODEL#	STANDARD FABRIC GRADES										
		List Price										
	<b>GC3622LNA</b>	<b>\$469</b>										
	Metal											
	<b>GC3622WLNA</b>	<b>\$258</b>										
	Wood											
		OVERALL DIMENSIONS			SEAT DIMENSIONS			BACK DIMENSIONS				
		W	D	H	W	D	H	W	H			
		1.25	24.25	16								
<b>Seat to Seat Central Linking Frame, Armless</b>		For <b>linking</b> guest and/or patient top seating units.										
COM Yardage: -- Freight Class: 150 Product Weight (lbs.): Metal: 5 / Wood: 4 Cubic Feet Per Carton: 1.2		<b>Does not allow linking to other units or tables.</b>										

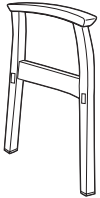
DESCRIPTION	MODEL#	STANDARD FABRIC GRADES										
		List Price										
	<b>GC3622LA</b>	<b>\$607</b>										
	Metal											
	<b>GC3622WLA</b>	<b>\$403</b>										
	Wood											
		OVERALL DIMENSIONS			SEAT DIMENSIONS			BACK DIMENSIONS				
		W	D	H	W	D	H	W	H			
		2.5	27	26.5								
<b>Center Frame, Open Arm</b>		For <b>linking</b> guest and/or patient top seating units.										
COM Yardage: -- Freight Class: 125 Product Weight (lbs.): Metal: 10 / Wood: 8 Cubic Feet Per Carton: 1.4		SSU armcap option - <b>Add \$49 list upcharge</b>										

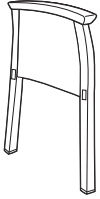

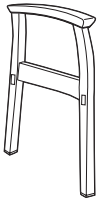

DESCRIPTION	MODEL#	STANDARD FABRIC GRADES											
		COM	2	3	4	5	6	7	8	9	10	11	12
	<b>GC3622LCA</b>	<b>\$684</b>	<b>\$703</b>	<b>\$720</b>	<b>\$747</b>	<b>\$783</b>	<b>\$797</b>	<b>\$826</b>	<b>\$886</b>	<b>\$914</b>	<b>\$968</b>	<b>\$1044</b>	<b>\$1138</b>
	Metal												
	<b>GC3622WLCA</b>	<b>\$502</b>	<b>\$521</b>	<b>\$540</b>	<b>\$565</b>	<b>\$602</b>	<b>\$615</b>	<b>\$644</b>	<b>\$704</b>	<b>\$732</b>	<b>\$788</b>	<b>\$862</b>	<b>\$956</b>
	Wood												
		OVERALL DIMENSIONS			SEAT DIMENSIONS			BACK DIMENSIONS					
		W	D	H	W	D	H	W	H				
		2.5	27	26.5									
<b>Center Frame, Closed Arm</b>		For <b>linking</b> guest and/or patient top seating units.											
COM Yardage: 0.65 Freight Class: 92.5 Product Weight (lbs.): Metal: 15 / Wood: 10 Cubic Feet Per Carton: 1.4		SSU armcap option - <b>Add \$49 list upcharge</b>											

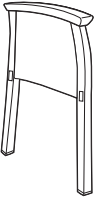

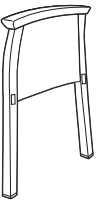
DESCRIPTION	MODEL#	STANDARD FABRIC GRADES										
		List Price										
	<b>GC3622TLA</b>	<b>\$593</b>										
	Metal											
	<b>GC3622WTLA</b>	<b>\$437</b>										
	Wood											
		OVERALL DIMENSIONS			SEAT DIMENSIONS			BACK DIMENSIONS				
		W	D	H	W	D	H	W	H			
		2.5	27	26.5								
<b>Center Frame, Open Arm</b>		For <b>linking</b> guest and/or patient top seating units to modular table on the <b>left</b> side of the frame.										
COM Yardage: -- Freight Class: 125 Product Weight (lbs.): Metal: 10 / Wood: 8 Cubic Feet Per Carton: 1.4		SSU armcap option - <b>Add \$49 list upcharge</b>										

DESCRIPTION	MODEL#	STANDARD FABRIC GRADES										
		List Price										
	<b>GC3622TRA</b>	<b>\$593</b>										
	Metal											
	<b>GC3622WTRA</b>	<b>\$437</b>										
	Wood											
		OVERALL DIMENSIONS			SEAT DIMENSIONS			BACK DIMENSIONS				
		W	D	H	W	D	H	W	H			
		2.5	27	26.5								
<b>Center Frame, Open Arm</b>		For <b>linking</b> guest and/or patient top seating units to modular table on the <b>right</b> side of the frame.										
COM Yardage: -- Freight Class: 125 Product Weight (lbs.): Metal: 10 / Wood: 8 Cubic Feet Per Carton: 1.4		SSU armcap option - <b>Add \$49 list upcharge</b>										

DESCRIPTION	MODEL#	STANDARD FABRIC GRADES											
		COM	2	3	4	5	6	7	8	9	10	11	12
	<b>GC3622TLCA</b>	<b>\$715</b>	<b>\$735</b>	<b>\$754</b>	<b>\$779</b>	<b>\$814</b>	<b>\$829</b>	<b>\$858</b>	<b>\$918</b>	<b>\$946</b>	<b>\$1002</b>	<b>\$1078</b>	<b>\$1170</b>
	Metal												
	<b>GC3622WTLCA</b>	<b>\$534</b>	<b>\$553</b>	<b>\$572</b>	<b>\$597</b>	<b>\$634</b>	<b>\$647</b>	<b>\$678</b>	<b>\$736</b>	<b>\$767</b>	<b>\$820</b>	<b>\$896</b>	<b>\$988</b>
	Wood												
Specify armcap: wood or SSU.		<b>OVERALL DIMENSIONS</b>			<b>SEAT DIMENSIONS</b>			<b>BACK DIMENSIONS</b>					
		<b>W</b>	<b>D</b>	<b>H</b>	<b>W</b>	<b>D</b>	<b>H</b>	<b>W</b>	<b>H</b>				
		2.5	27	26.5									
<b>Center Frame, Closed Arm</b> COM Yardage: 0.65 Freight Class: 92.5 Product Weight (lbs.) Metal: 15/ Wood: 10 Cubic Feet Per Carton: 1.4		For <b>linking</b> guest and/or patient top seating units to modular table on the <b>left</b> side of the frame.  SSU armcap option - <b>Add \$49 list upcharge</b>											

DESCRIPTION	MODEL#	STANDARD FABRIC GRADES											
		COM	2	3	4	5	6	7	8	9	10	11	12
	<b>GC3622TRCA</b>	<b>\$715</b>	<b>\$735</b>	<b>\$754</b>	<b>\$779</b>	<b>\$814</b>	<b>\$829</b>	<b>\$858</b>	<b>\$918</b>	<b>\$946</b>	<b>\$1002</b>	<b>\$1078</b>	<b>\$1170</b>
	Metal												
	<b>GC3622WTRCA</b>	<b>\$534</b>	<b>\$553</b>	<b>\$572</b>	<b>\$597</b>	<b>\$634</b>	<b>\$647</b>	<b>\$678</b>	<b>\$736</b>	<b>\$767</b>	<b>\$820</b>	<b>\$896</b>	<b>\$988</b>
	Wood												
Specify armcap: wood or SSU.		<b>OVERALL DIMENSIONS</b>			<b>SEAT DIMENSIONS</b>			<b>BACK DIMENSIONS</b>					
		<b>W</b>	<b>D</b>	<b>H</b>	<b>W</b>	<b>D</b>	<b>H</b>	<b>W</b>	<b>H</b>				
		2.5	27	26.5									
<b>Center Frame, Closed Arm</b> COM Yardage: 0.65 Freight Class: 92.5 Product Weight (lbs.) Metal: 15 / Wood: 10 Cubic Feet Per Carton: 1.4		For <b>linking</b> guest and/or patient top seating units to modular table on the <b>right</b> side of the frame.  SSU armcap option - <b>Add \$49 list upcharge</b>											

DESCRIPTION	MODEL#	STANDARD FABRIC GRADES							
  <b>Dining Armcap, Left</b> COM Yardage: -- Freight Class: 250 Product Weight (lbs.) SSU: 2 / Wood: 1.5 Cubic Feet Per Carton: 0.6		List Price							
	<b>GC3616SSULACAP</b>	<b>\$163</b>							
	SSU								
	<b>GC3616WLACAP</b>	<b>\$195</b>							
		OVERALL DIMENSIONS			SEAT DIMENSIONS			BACK DIMENSIONS	
		W	D	H	W	D	H	W	H
		0	0	0					
		Armcap with hardware for dining top seating units. <i>For field replacement only.</i>							
  <b>Dining Armcap, Right</b> COM Yardage: -- Freight Class: 250 Product Weight (lbs.) SSU: 2 / Wood: 1.5 Cubic Feet Per Carton: 0.6		List Price							
	<b>GC3616SSURACAP</b>	<b>\$163</b>							
	SSU								
	<b>GC3616WRACAP</b>	<b>\$195</b>							
		OVERALL DIMENSIONS			SEAT DIMENSIONS			BACK DIMENSIONS	
		W	D	H	W	D	H	W	H
		0	0	0					
		Armcap with hardware dining top seating units. <i>For field replacement only.</i>							
  <b>Guest/Patient Armcap, Left</b> COM Yardage: -- Freight Class: 150 Product Weight (lbs.) SSU: 2.5 / Wood: 2 Cubic Feet Per Carton: 0.6		List Price							
	<b>GC3620SSULACAP</b>	<b>\$163</b>							
	SSU								
	<b>GC3620WLACAP</b>	<b>\$195</b>							
		OVERALL DIMENSIONS			SEAT DIMENSIONS			BACK DIMENSIONS	
		W	D	H	W	D	H	W	H
		0	0	0					
		Armcap with hardware for guest/patient top seating units. <i>For field replacement only.</i>							
  <b>Guest/Patient Armcap, Right</b> COM Yardage: -- Freight Class: 150 Product Weight (lbs.) SSU: 2.5 / Wood: 2 Cubic Feet Per Carton: 0.6		List Price							
	<b>GC3620SSURACAP</b>	<b>\$163</b>							
	(SSU)								
	<b>GC3620WRACAP</b>	<b>\$195</b>							
		OVERALL DIMENSIONS			SEAT DIMENSIONS			BACK DIMENSIONS	
		W	D	H	W	D	H	W	H
		0	0	0					
		Armcap with hardware for guest/patient top seating units. <i>For field replacement only.</i>							
  <b>Narrow Center Armcap</b> COM Yardage: -- Freight Class: 70 Product Weight (lbs.) SSU: 1.5 / Wood: 1.5 Cubic Feet Per Carton: 0.6		List Price							
	<b>GC3622SSULACAP</b>	<b>\$163</b>							
	(SSU)								
	<b>GC3622WLACAP</b>	<b>\$195</b>							
		OVERALL DIMENSIONS			SEAT DIMENSIONS			BACK DIMENSIONS	
		W	D	H	W	D	H	W	H
		0	0	0					
		Armcap with hardware for guest/patient top seating units. <i>For field replacement only.</i>							

DESCRIPTION	MODEL#	STANDARD FABRIC GRADES								
		List Price								
	<b>GC3641SSULACAP</b>	<b>\$184</b>								
	SSU									
	<b>GC3641WLACAP</b>	<b>\$231</b>								
	Wood									
		OVERALL DIMENSIONS			SEAT DIMENSIONS			BACK DIMENSIONS		
		W	D	H	W	D	H	W	H	
		3	26.75	1.5						
<b>Lounge Armcap, Left</b> COM Yardage: -- Freight Class: 150 Product Weight (lbs.) SSU: 2.5 / Wood: 2 Cubic Feet Per Carton: 0.6		Armcap with hardware <b>for Lounge chair</b> For field replacement only.								
		List Price								
	<b>GC3641SSURACAP</b>	<b>\$184</b>								
	SSU									
	<b>GC3641WRACAP</b>	<b>\$231</b>								
	Wood									
		OVERALL DIMENSIONS			SEAT DIMENSIONS			BACK DIMENSIONS		
		W	D	H	W	D	H	W	H	
		3	26.75	1.5						
<b>Lounge Armcap, Right</b> COM Yardage: -- Freight Class: 150 Product Weight (lbs.) SSU: 2.5 / Wood: 2 Cubic Feet Per Carton: 0.6		Armcap with hardware <b>for Lounge chair</b> For field replacement only.								

**Modular tables:**

Tops are 1" thick.

**Wooden leg tables:**

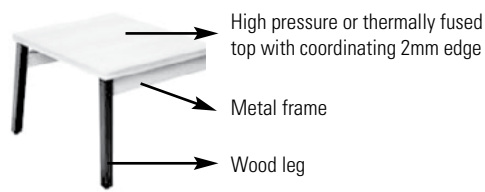

**Metal leg tables:**

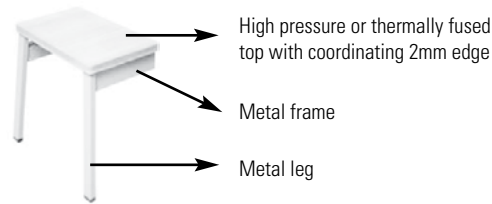

**Table top finishes:**

**Thermally Fused Laminate (LP)**

- Absolute Acajou (ACJ)
- Asian Night (ASN)
- Avant Cherry (AWC)
- Avant Honey (AWH)
- Brushed Cobalt (BRC)
- Clear Maple (CMB)
- Dark Espresso (DES)
- Designer White (DWT)
- Hayden Grey (HGT)
- Noce Biondo (NBL)
- Noce Grigio (NGL)
- Noce Leggero (NEL)
- Noce Medio (NML)
- Quartered Mahogany (QTM)
- Tiger Fruitwood (TFW)
- Tiger Walnut (TWL)
- Walnut Heights (WHE)
- White Chocolate (WHC)
- Winter Cherry (WCR)

**High Pressure Laminate (HP)**

- Absolute Acajou (ACJ)
- Asian Night (ASN)
- Avant Cherry (W357)
- Avant Honey (W356)
- Brushed Cobalt (BRC)
- Clear Maple (CMB)
- Dark Espresso (W142)
- Designer White (DWT)
- Hayden Grey (HGT)
- Noce Biondo (NBL)
- Noce Grigio (NGL)
- Noce Leggero (NEL)
- Noce Medio (NML)
- Quartered Mahogany (QTM)
- Tiger Fruitwood (TFW)
- Tiger Walnut (W819)
- Walnut Heights (WHE)
- White Chocolate (WHC)
- Winter Cherry (WCR)

**Wooden leg finishes (top, base, legs & apron):**

- |                       |                      |                     |
|-----------------------|----------------------|---------------------|
| Absolute (AAM)        | Jet Onyx (JOM)       | Noce Medio (NMM)    |
| Charcoal Java (CJM)   | Light Honey (LHM)    | Sandy Beach (SBM)   |
| Cherry (ACM)          | Mahogany (TMM)       | Shaker Cherry (SKM) |
| Empire Mahogany (EMM) | Maple (AVM)          | Silver Oak (SOM)    |
| English Oak (EOM)     | Medium Walnut (MWM)  | Walnut (TWM)        |
| Espresso Cafe (ECM)   | Natural Walnut (NLW) | White (WHM)         |
| Fruitwood (TFM)       | Night (ASM)          | WC Cream (WTM)      |
| Gray (HGM)            | Noce Biondo (NBM)    | Winter Cherry (WCM) |
| Harvest Oak (HOM)     | Noce Grigio (NGM)    |                     |
| Honey (AHM)           | Noce Leggero (NEM)   |                     |

**Metal leg finishes:**

Black (BLK), Latte (LAB), Kalua (KAL), Mocha (J52), Shadow (SHW), Toast (TOA) and Tungsten (TUN). Please specify.

**Metal frame finishes:**

Black (BLK), Latte (LAB), Kalua (KAL), Mocha (J52), Shadow (SHW), Toast (TOA) and Tungsten (TUN). Please specify.

**Power/USB modules:**

For modular tables with power/USB module, refer to models ending in "M". Power module includes two power outlets, four USB charging ports and a 6 foot long power cord. Available in Black or White (must be specified at time of order). Power module is mounted **on surface** on narrow tables; mounted **in surface** on larger tables.



On surface power module on narrow tables

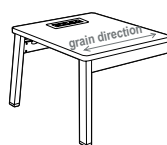

In surface power module on larger tables

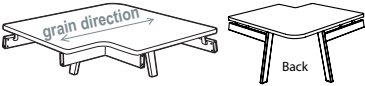

DESCRIPTION	MODEL#	STANDARD FABRIC GRADES				
	GC3671WL-LP	33 x 33 x 17	100	54	6	<b>\$1233</b>
	GC3671WLM-LP					<b>\$2462</b>
	GC3671WL-HP	33 x 33 x 17	100	54	6	<b>\$1317</b>
	GC3671WLM-HP					<b>\$2560</b>

- For a thermally fused laminate top (LP), specify model GC3671WL-LP.
- For a high pressure laminate top (HP), specify model GC3671WL-HP.
- Models GC3671WLM-LP and GC3671WLM-HP have a **power/USB** module mounted in surface.

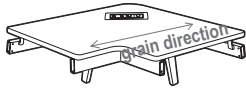

Left Corner Table, for Wood Frame

Coordinating 2mm edge. Must be connected to full arm and leg with **wood** frames. (GC3622WTLA/WTRA, GC3622WTLCA/WTRCA). This table allows for kneespace when specifying chairs in a corner position. 1 per carton.  
 • Includes 2 rear wood legs (not shown)

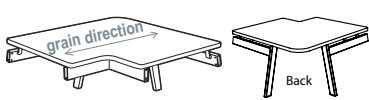

Left Corner Table, for Metal Frame

GC3671L-LP	33 x 33 x 17	100	53	6	<b>\$1307</b>
GC3671LM-LP					<b>\$2549</b>
GC3671L-HP	33 x 33 x 17	100	54	6	<b>\$1391</b>
GC3671LM-HP					<b>\$2647</b>

- For a thermally fused laminate top (LP), specify model GC3671L-LP.
- For a high pressure laminate top (HP), specify model GC3671L-HP.
- Models GC3671LM-LP and GC3671LM-HP have a **power/USB** module mounted in surface.



Coordinating 2mm edge. Must be connected to full arm and leg with **metal** frames. (GC3622TLA/TRA, GC3622TLCA/TRCA). This table allows for kneespace when specifying chairs in a corner position. 1 per carton.  
 • Includes 2 rear metal legs (not shown)

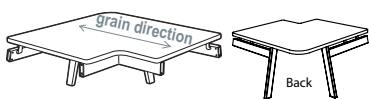

Right Corner Table, for Wood Frame

GC3671WR-LP	33 x 33 x 17	100	54	6	<b>\$1233</b>
GC3671WRM-LP					<b>\$2462</b>
GC3671WR-HP	33 x 33 x 17	100	54	6	<b>\$1317</b>
GC3671WRM-HP					<b>\$2560</b>

- For a thermally fused laminate top (LP), specify model GC3671WR-LP.
- For a high pressure laminate top (HP), specify model GC3671WR-HP.
- Models GC3671WRM-LP and GC3671WRM-HP have a **power/USB** module mounted in surface.



Coordinating 2mm edge. Must be connected to full arm and leg with **wood** frames. (GC3622WTLA/WTRA, GC3622WTLCA/WTRCA). This table allows for kneespace when specifying chairs in a corner position. 1 per carton.  
 • Includes 2 rear wood legs (not shown)

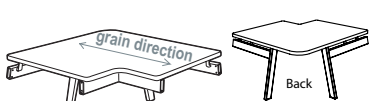

Right Corner Table, for Metal Frame

GC3671R-LP	33 x 33 x 17	100	54	6	<b>\$1307</b>
GC3671RM-LP					<b>\$2549</b>
GC3671R-HP	33 x 33 x 17	125	45	6	<b>\$1391</b>
GC3671RM-HP					<b>\$2647</b>

- For a thermally fused laminate top (LP), specify model GC3671R-LP.
- For a high pressure laminate top (HP), specify model GC3671R-HP.
- Models GC3671RM-LP and GC3671RM-HP have a **power/USB** module mounted in surface.



Coordinating 2mm edge. Must be connected to full arm and leg with **metal** frames (GC3622TLA/TRA, GC3622TLCA/TRCA). This table allows for kneespace when specifying chairs in a corner position. 1 per carton.  
 • Includes 2 rear metal legs (not shown).



Center Table

GC3672-LP	23.87 x 20.25 x 5.5	150	20	3.4	<b>\$745</b>
GC3672M-LP					<b>\$1927</b>
GC3672-HP	23.87 x 20.25 x 5.5	150	20	3.4	<b>\$782</b>
GC3672M-HP					<b>\$1971</b>

- For a thermally fused laminate top (LP), specify model GC3672-LP.
- For a high pressure laminate top (HP), specify model GC3672-HP.
- Models GC3672M-LP and GC3672M-HP have a **power/USB** module mounted in surface.



Coordinating 2mm edge. Regular center table for **wood** or **metal** (HT) frame. Must be connected to full arm and leg with **metal** or **wood** frames (GC3622TLA/TRA, GC3622TLCA/TRCA, GC3622WTLA/WTRA, GC3622WTLCA/WTRCA). 1 per carton.

DESCRIPTION	MODEL#	STANDARD FABRIC GRADES				
-------------	--------	------------------------	--	--	--	--



GC3673-LP	23.87 x 12 x 5.5	100	18	2.1	<b>\$725</b>
GC3673M-LP					<b>\$2061</b>
GC3673-HP	23.87 x 12 x 5.5	100	18	2.1	<b>\$760</b>
GC3673M-HP					<b>\$2106</b>



- For a thermally fused laminate top (LP), specify model GC3673-LP.
- For a high pressure laminate top (HP), specify model GC3673-HP.
- Models GC3673M-LP and GC3673M-HP have a **power/USB** module mounted on surface.

**Narrow Center Table**

Coordinating 2mm edge. Narrow center table for **wood or metal** (HT) frame. Must be connected to full arm and leg with **metal or wood** frames (GC3622TLA/TRA, GC3622TLCA/TRCA, GC3622WTLA/WTRA, GC3622WTLCA/WTRCA).  
1 per carton

GC3674WL-LP	23.87 x 20.25 x 17	150	19	3.4	<b>\$1042</b>
GC3674WLM-LP					<b>\$2253</b>
GC3674WL-HP	23.87 x 20.25 x 17	150	20	3.4	<b>\$1079</b>
GC3674WLM-HP					<b>\$2296</b>

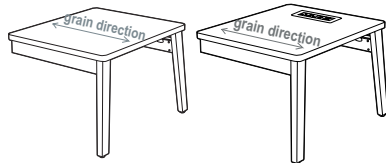

- For a thermally fused laminate top (LP), specify model GC3674WL-LP.
- For a high pressure laminate top (HP), specify model GC3674WL-HP.
- Models GC3674WLM-LP and GC3674WLM-HP have a **power/USB** module mounted in surface.

**Left End Table, for Wood Frame**

Coordinating 2mm edge. Must be connected to full arm and leg with **wood** frames (GC3622WTLA or GC3622WTLCA).  
1 per carton.

GC3674L-LP	23.87 x 20.25 x 17	150	19	3.4	<b>\$1118</b>
GC3674LM-LP					<b>\$2338</b>
GC3674L-HP	23.87 x 20.25 x 17	150	20	3.4	<b>\$1157</b>
GC3674LM-HP					<b>\$2381</b>

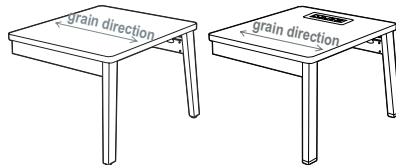

- For a thermally fused laminate top (LP), specify model GC3674L-LP.
- For a high pressure laminate top (HP), specify model GC3674L-HP.
- Models GC3674LM-LP and GC3674LM-HP have a **power/USB** module mounted in surface.

**Left End Table, for Metal Frame**

Coordinating 2mm edge. Must be connected to full arm and leg with **metal** frames. (GC3622TLA or GC3622TLCA).  
1 per carton.

GC3674WR-LP	23.87 x 20.25 x 17	150	19	3.4	<b>\$1042</b>
GC3674WRM-LP					<b>\$2253</b>
GC3674WR-HP	23.87 x 20.25 x 17	150	20	3.4	<b>\$1079</b>
GC3674WRM-HP					<b>\$2296</b>

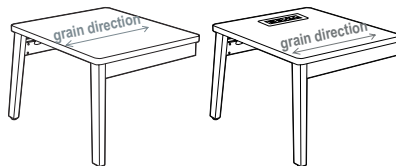

- For a thermally fused laminate top (LP), specify model GC3674WR-LP.
- For a high pressure laminate top (HP), specify model GC3674WR-HP.
- Models GC3674WRM-LP and GC3674WRM-HP have a **power/USB** module mounted in surface.

**Right End Table, for Wood Frame**

Coordinating 2mm edge. Must be connected to full arm and leg with **wood** frames. (GC3622WTRA or GC3622WTRCA).  
1 per carton.

GC3674R-LP	23.87 x 20.25 x 17	150	19	3.4	<b>\$1118</b>
GC3674RM-LP					<b>\$2338</b>
GC3674R-HP	23.87 x 20.25 x 17	150	20	3.4	<b>\$1157</b>
GC3674RM-HP					<b>\$2381</b>

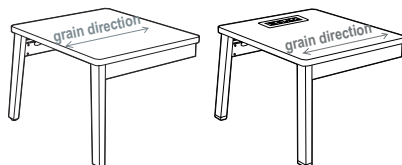

- For a thermally fused laminate top (LP), specify model GC3674R-LP.
- For a high pressure laminate top (HP), specify model GC3674R-HP.
- Models GC3674RM-LP and GC3674RM-HP have a **power/USB** module mounted in surface.

**Right End Table, for Metal Frame**

Coordinating 2mm edge. Must be connected to full arm and leg with **metal** frames. (GC3622TRA or GC3622TRCA).  
1 per carton.

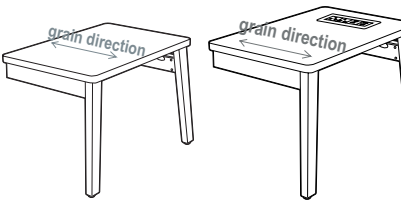
MODULAR TABLES	MODEL#	DIMENSIONS D x W x H	FREIGHT CLASS	WT/LBS.	CUBIC FT.	LIST PRICE
	GC3675WL-LP	23.87 x 12 x 17	100	18	2.1	<b>\$1019</b>
	GC3675WLM-LP					<b>\$2413</b>
	GC3675WL-HP	23.87 x 12 x 17	100	18	2.1	<b>\$1058</b>
	GC3675WLM-HP					<b>\$2460</b>

**Narrow Left End Table, for Wood Frame**

- For a thermally fused laminate top (LP), specify model GC3675WL-LP.
- For a high pressure laminate top (HP), specify model GC3675WL-HP.
- Models GC3675WLM-LP and GC3675WLM-HP have a **power/USB** module mounted on surface.

Coordinating 2mm edge. Must be connected to full arm and leg with **wood** frames. (GC3622WTLA or GC3622WTLCA).  
1 per carton.

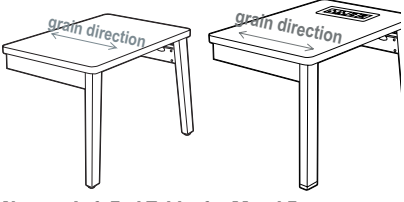
	GC3675L-LP	23.87 x 12 x 17	100	18	2.1	<b>\$1097</b>
	GC3675LM-LP					<b>\$2507</b>
	GC3675L-HP	23.87 x 12 x 17	100	18	2.1	<b>\$1136</b>
	GC3675LM-HP					<b>\$2553</b>

**Narrow Left End Table, for Metal Frame**

- For a thermally fused laminate top (LP), specify model GC3675L-LP.
- For a high pressure laminate top (HP), specify model GC3675L-HP.
- Models GC3675LM-LP and GC3675LM-HP have a **power/USB** module mounted on surface.

Coordinating 2mm edge. Must be connected to full arm and leg with **metal** frames. (GC3622TLA or GC3622TLCA).  
1 per carton.

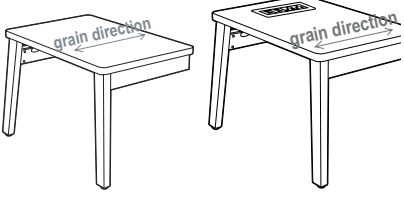
	GC3675WR-LP	23.87 x 12 x 17	100	18	2.1	<b>\$1019</b>
	GC3675WRM-LP					<b>\$2413</b>
	GC3675WR-HP	23.87 x 12 x 17	100	18	2.1	<b>\$1058</b>
	GC3675WRM-HP					<b>\$2460</b>

**Narrow Right End Table, for Wood Frame**

- For a thermally fused laminate top (LP), specify model GC3675WR-LP.
- For a high pressure laminate top (HP), specify model GC3675WR-HP.
- Models GC3675WRM-LP and GC3675WRM-HP have a **power/USB** module mounted on surface.

Coordinating 2mm edge. Must be connected to full arm and leg with **wood** frames. (GC3622WTLA or GC3622WTLCA).  
1 per carton.

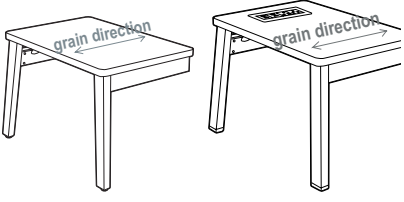
	GC3675R-LP	23.87 x 12 x 17	100	18	2.1	<b>\$1097</b>
	GC3675RM-LP					<b>\$2507</b>
	GC3675R-HP	23.87 x 12 x 17	100	18	2.1	<b>\$1136</b>
	GC3675RM-HP					<b>\$2553</b>

**Narrow Right End Table, for Metal Frame**

- For a thermally fused laminate top (LP), specify model GC3675R-LP.
- For a high pressure laminate top (HP), specify model GC3675R-HP.
- Models GC3675RM-LP and GC3675RM-HP have a **power/USB** module mounted on surface.

Coordinating 2mm edge. Must be connected to full arm and leg with **metal** frames. (GC3622TLA or GC3622TLCA).  
1 per carton.

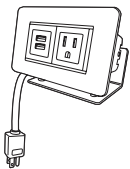

**On Surface Power/Data Module**

GC36410	-- x -- x --	250	2	1	<b>\$680</b>
---------	--------------	-----	---	---	--------------

Surface top mount power/data module with one power outlet, two USB charging ports. 6 foot cord. White. Can be mounted to all freestanding and modular tables.

DESCRIPTION MODEL# / FEATURES STANDARD TEXTILE GRADES

MODULAR TOP UNITS

FOR MODULAR LOUNGE AND FULLY UPHOLSTERED LOUNGE

SINGLE SEAT BARIATRIC TWO SEATER THREE SEATER  
 GC3641TOP GC3640TOP GC3642TOP GC3643TOP



LEG / ARM FRAMES

FOR MODULAR LOUNGE

Metal frame: Standard with Black SSU armcap (see notes for wood and SSU finish options) | Wood frame: Must select armcap

	LEFT, OPEN	RIGHT, OPEN	LEFT, CLOSED	RIGHT, CLOSED	LEFT, CLOSED LAMINATE PANEL	RIGHT, CLOSED LAMINATE PANEL
<b>Metal (HT) End</b>	GC3641LA 	GC3641LAM 	GC3641RA 	GC3641RAM 	GC3641LCA 	GC3641RCAM 
<b>Wood End</b>	GC3641WLA 	GC3641WLAM 	GC3641WRA 	GC3641WRAM 	GC3641WLCA 	GC3641WLCAM 
<b>Metal (HT) Center</b>	GC36406LA 		GC36406LCA 		GC36406LCAL 	
<b>Wood, Center</b>	GC36406WLA 		GC36406WLCAL 			
<b>Metal (HT) Center table linking</b>	GC36406TLA 	GC3622TRA 	GC36406TLCA 	GC36406TRCA 	GC36406TLCAL 	GC36406TRCAL 
<b>Wood Center table linking</b>	GC36406WTLA 	GC3622WTRA 	GC36406WTLCA 	GC36406WTRCA 		

For frame with power/USB module\*, add "M" after model number

LEG / ARM FRAMES

FOR FULLY UPHOLSTERED MODULAR LOUNGE

Standard with Black SSU legs (see notes for wood and SSU finish options)  
 Optional armcap in wood or SSU (cannot be retrofitted in the field if the frame is ordered without armcap)

	LEFT	RIGHT
<b>Fully Upholstered End</b>	GC3676LA 	GC3676RA 
<b>Fully Upholstered Center</b>	GC3676CFA 	

(Center = link both sides)

\*Power module includes two power outlets, four USB charging ports and a 6 foot long power cord. Available in Black or White (must be specified at time of order). Power module is mounted on the frame below seat support rail.

DESCRIPTION

MODEL# / FEATURES

STANDARD TEXTILE GRADES





**MODULAR TABLES FOR MODULAR LOUNGE AND FULLY UPHOLSTERED LOUNGE**

Tables include legs to support table top (except for center tables). All tables have a metal frame.



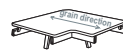

LEFT

RIGHT



**Corner**  
(laminated top with metal legs)

GC36403L-HP	GC36403LM-HP	GC36403R-HP	GC36403RM-HP
GC36403L-LP	GC36403LM-LP	GC36403R-LP	GC36403RM-LP
			



**Corner**  
(laminated top with wood legs)

GC36403WL-HP	GC36403WLM-HP	GC36403WR-HP	GC36403WRM-HP
GC36403WL-LP	GC36403WLM-LP	GC36403WR-LP	GC36403WRM-LP
			



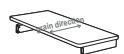

**Center**  
(laminated top, connects to metal or wood frame)

GC36401-HP	GC36401M-HP
GC36401-LP	GC36401M-LP
	





**Narrow Center**  
(laminated top, connects to metal or wood frame)

GC36402-HP	GC36402M-HP
GC36402-LP	GC36402M-LP
	





**End**  
(laminated top with metal legs)

GC36404L-HP	GC36404LM-HP	GC36404R-HP	GC36404RM-HP
GC36404L-LP	GC36404LM-LP	GC36404R-LP	GC36404RM-LP
			



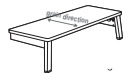

**End**  
(laminated top with wood legs)

GC36404WL-HP	GC36404WLM-HP	GC36404WR-HP	GC36404WRM-HP
GC36404WL-LP	GC36404WLM-LP	GC36404WR-LP	GC36404WRM-LP
			

**Narrow End**  
(laminated top with metal legs)

GC36405L-HP	GC36405LM-HP	GC36405R-HP	GC36405RM-HP
GC36405L-LP	GC36405LM-LP	GC36405R-LP	GC36405RM-LP
			

**Narrow End**  
(laminated top with wood legs)

GC36405WL-HP	GC36405WLM-HP	GC36405WR-HP	GC36405WRM-HP
GC36405WL-LP	GC36405WLM-LP	GC36405WR-LP	GC36405WRM-LP
			

For table with power/USB module\*, refer to models ending in "M"

\* Power module includes two power outlets, four USB charging ports and a 6 foot long power cord. Available in Black or White (must be specified at time of order). Power module is mounted on surface on narrow tables; mounted in surface on larger tables (as shown above).

# SEATING

# PRIMACARE™ MODULAR - LOUNGE P

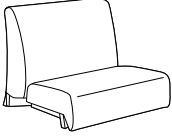
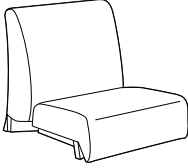
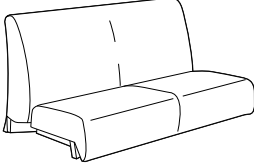
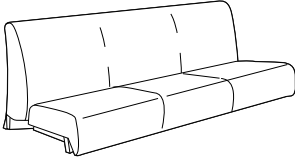
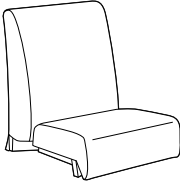
DESCRIPTION	MODEL# / FEATURES	STANDARD TEXTILE GRADES												
		COM	2	3	4	5	6	7	8	9	10	11	12	
 <p><b>Lounge Bariatric Top</b> COM Yardage: 3.25 Freight Class: 300 Product Weight (lbs.): 97 Cubic Feet Per Carton: 49.5</p>	<b>GC3640TOP</b>	\$2106	\$2209	\$2294	\$2420	\$2600	\$2682	\$2843	\$3102	\$3300	\$3522	\$3975	\$4460	
	Active weight: see notes.	<b>OVERALL DIMENSIONS</b>			<b>SEAT DIMENSIONS</b>			<b>BACK DIMENSIONS</b>						
	Single frame lounge top unit with 1 back and 1 seat cushion.	<b>W</b>	<b>D</b>	<b>H</b>	<b>W</b>	<b>D</b>	<b>H</b>	<b>W</b>	<b>H</b>					
		36	32	25	36	20	-	36	16					
		<b>Must be connected to a full arm/leg frame.</b>												
 <p><b>Lounge Single Seater Top</b> COM Yardage: 2.5 Freight Class: 250 Product Weight (lbs.): 66 Cubic Feet Per Carton: 29.5</p>	<b>GC3641TOP</b>	\$1511	\$1590	\$1654	\$1753	\$1890	\$1955	\$2078	\$2276	\$2429	\$2600	\$2947	\$3320	
	Active weight: see notes.	<b>OVERALL DIMENSIONS</b>			<b>SEAT DIMENSIONS</b>			<b>BACK DIMENSIONS</b>						
	Single frame lounge top unit with 1 back and 1 seat cushion.	<b>W</b>	<b>D</b>	<b>H</b>	<b>W</b>	<b>D</b>	<b>H</b>	<b>W</b>	<b>H</b>					
		25	32	25	23	20	-	22.5	16					
		<b>Must be connected to a full arm/leg frame.</b>												
 <p><b>Lounge Two Seater Top</b> COM Yardage: 4 Freight Class: 250 Product Weight (lbs.): 110 Cubic Feet Per Carton: 49.5</p>	<b>GC3642TOP</b>	\$2679	\$2804	\$2912	\$3065	\$3286	\$3389	\$3589	\$3904	\$4149	\$4420	\$4977	\$5575	
	Active weight: see notes.	<b>OVERALL DIMENSIONS</b>			<b>SEAT DIMENSIONS</b>			<b>BACK DIMENSIONS</b>						
	Double frame lounge top unit with 2 back and 2 seat cushions.	<b>W</b>	<b>D</b>	<b>H</b>	<b>W</b>	<b>D</b>	<b>H</b>	<b>W</b>	<b>H</b>					
		48	32	25	48	20	-	48	16					
		<b>Must be connected to a full arm/leg frame.</b>												
 <p><b>Lounge Three Seater Top</b> COM Yardage: 6.25 Freight Class: 250 Product Weight (lbs.): 161 Cubic Feet Per Carton: 69.5</p>	<b>GC3643TOP</b>	\$4419	\$4619	\$4782	\$5024	\$5366	\$5529	\$5838	\$6332	\$6716	\$7139	\$8011	\$8944	
	<b>Due to the size and weight, this top requires at least 3 installers.</b>													
	Active weight: see notes.	<b>OVERALL DIMENSIONS</b>			<b>SEAT DIMENSIONS</b>			<b>BACK DIMENSIONS</b>						
	Triple frame lounge top unit with 3 back and 3 seat cushions.	<b>W</b>	<b>D</b>	<b>H</b>	<b>W</b>	<b>D</b>	<b>H</b>	<b>W</b>	<b>H</b>					
	71	32	25	71	20	-	71	16						
		<b>Must be connected to a full arm/leg frame.</b>												
 <p><b>HB Lounge Single Seater Top</b> COM Yardage: 6.5 Freight Class: 250 Product Weight (lbs.): 92 Cubic Feet Per Carton: 29.5</p>	<b>GC3676HB-TOP</b>	\$1467	\$1671	\$1840	\$2089	\$2441	\$2607	\$2928	\$3437	\$3831	\$4267	\$5167	\$6129	
	Active weight: see notes.	<b>OVERALL DIMENSIONS</b>			<b>SEAT DIMENSIONS</b>			<b>BACK DIMENSIONS</b>						
	Single high back frame lounge top, 1 back and 1 seat cushion.	<b>W</b>	<b>D</b>	<b>H</b>	<b>W</b>	<b>D</b>	<b>H</b>	<b>W</b>	<b>H</b>					
		23	29	36	23	20	-	23	19					
		<b>Must be connected to a full arm/leg frame.</b>												

DESCRIPTION MODEL# / FEATURES STANDARD TEXTILE GRADES

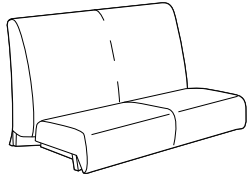

**HB Lounge Two Seater Top**  
 COM Yardage: 7.75  
 Freight Class: 250  
 Product Weight (lbs.): 117  
 Cubic Feet Per Carton: 56.25

MODEL# / FEATURES	COM	2	3	4	5	6	7	8	9	10	11	12
<b>GC3677HB-TOP</b>	<b>\$2728</b>	<b>\$2972</b>	<b>\$3172</b>	<b>\$3469</b>	<b>\$3889</b>	<b>\$4089</b>	<b>\$4470</b>	<b>\$5078</b>	<b>\$5547</b>	<b>\$6067</b>	<b>\$7140</b>	<b>\$8285</b>

Active weight: see notes.

Double high back frame lounge top unit with 2 back and 2 seat cushions.

**Must be connected to a full arm/leg frame.**

OVERALL DIMENSIONS			SEAT DIMENSIONS			BACK DIMENSIONS	
W	D	H	W	D	H	W	H
45.5	29	36	45.5	20	-	45.5	19

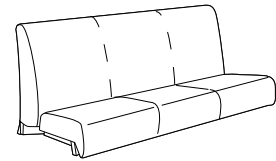

**HB Lounge Three Seater Top**  
 COM Yardage: 9.25  
 Freight Class: 250  
 Product Weight (lbs.): 158  
 Cubic Feet Per Carton: 69.5

MODEL# / FEATURES	COM	2	3	4	5	6	7	8	9	10	11	12
<b>GC3678HB-TOP</b>	<b>\$4575</b>	<b>\$4867</b>	<b>\$5105</b>	<b>\$5460</b>	<b>\$5961</b>	<b>\$6198</b>	<b>\$6653</b>	<b>\$7379</b>	<b>\$7939</b>	<b>\$8561</b>	<b>\$9841</b>	<b>\$11206</b>

Active weight: see notes.

Triple high back frame lounge top unit with 3 back and 3 seat cushions.

**Must be connected to a full arm/leg frame.**

OVERALL DIMENSIONS			SEAT DIMENSIONS			BACK DIMENSIONS	
W	D	H	W	D	H	W	H
68.5	29	36	68.5	20	--	71	19

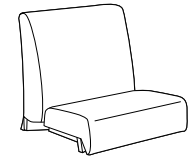

**HB Lounge Bariatric Top**  
 COM Yardage: 6.75  
 Freight Class: 250  
 Product Weight (lbs.): 96  
 Cubic Feet Per Carton: 37.75

MODEL# / FEATURES	COM	2	3	4	5	6	7	8	9	10	11	12
<b>GC3679HB-TOP</b>	<b>\$2294</b>	<b>\$2508</b>	<b>\$2682</b>	<b>\$2941</b>	<b>\$3307</b>	<b>\$3479</b>	<b>\$3812</b>	<b>\$4341</b>	<b>\$4751</b>	<b>\$5204</b>	<b>\$6138</b>	<b>\$7135</b>

Active weight: see notes.



Single high back frame bariatric lounge top, 1 back and 1 seat cushion.



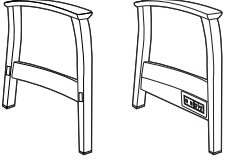
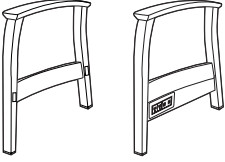
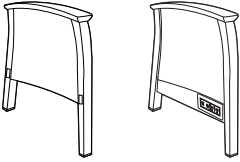
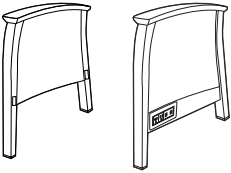
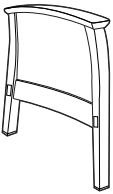

**Must be connected to a full arm/leg frame.**

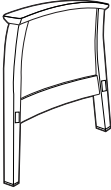
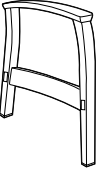
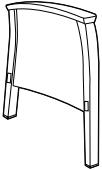
OVERALL DIMENSIONS			SEAT DIMENSIONS			BACK DIMENSIONS	
W	D	H	W	D	H	W	H
32	29	36	32	20	--	32	19

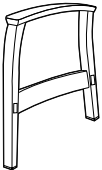
DESCRIPTION	MODEL# / FEATURES	STANDARD TEXTILE GRADES											
	List price												
	<b>GC3641LA</b> (metal) <b>\$710</b> <b>GC3641LAM</b> (w/power) <b>\$1871</b>  <b>GC3641WLA</b> (wood) <b>\$478</b> <b>GC3641WLAM</b> (wood) <b>\$1639</b> Specify armcap: wood or SSU.	OVERALL DIMENSIONS			SEAT DIMENSIONS			BACK DIMENSIONS					
<b>Lounge Left End Frame, Open Arm</b> COM Yardage: -- Freight Class: 150 Product Weight (lbs.): metal: 9.67   wood: 11 Cubic Feet Per Carton: 2.1	For use in <b>left</b> side finished position of lounge seating units. • Models GC3641LAM and GC3641WLAM have <b>power/USB module</b> <b>Does not allow linking to other units or tables.</b> SSU armcap option - <b>Add \$49 list upcharge</b>	3.5	29	25.25	-	-	-	-	-	-	-	-	
	List price												
	<b>GC3641RA</b> (metal) <b>\$710</b> <b>GC3641RAM</b> (w/power) <b>\$1871</b>  <b>GC3641WRA</b> (wood) <b>\$478</b> <b>GC3641WRAM</b> (w/power) <b>\$1639</b> Specify armcap: wood or SSU.	OVERALL DIMENSIONS			SEAT DIMENSIONS			BACK DIMENSIONS					
<b>Lounge Right End Frame, Open Arm</b> COM Yardage: -- Freight Class: 150 Product Weight (lbs.): metal: 9.67   wood: 11 Cubic Feet Per Carton: 2.1	For use in <b>right</b> side finished position of lounge seating units. • Models GC3641RAM and GC3641WRAM have <b>power/USB module</b> <b>Does not allow linking to other units or tables.</b> SSU armcap option - <b>Add \$49 list upcharge</b>	3.5	29	25.25	-	-	-	-	-	-	-	-	
	COM 2 3 4 5 6 7 8 9 10 11 12												
	<b>GC3641LCA</b> (metal) <b>\$894</b> <b>GC3641LCAM</b> (w/power) <b>\$2065</b>  <b>GC3641WLCA</b> (wood) <b>\$619</b> <b>GC3641WLCAM</b> (w/power) <b>\$1781</b> Specify armcap: wood or SSU.	\$916	\$937	\$965	\$1007	\$1026	\$1062	\$1122	\$1168	\$1218	\$1321	\$1432	
<b>Lounge Left End Frame, Closed Arm</b> COM Yardage: 0.75 Freight Class: 150 Product Weight (lbs.): metal: 10.17   wood: 11 Cubic Feet Per Carton: 2.1	For use in <b>left</b> side finished position of lounge seating units. • Models GC3641LCAM and GC3641WLCAM have <b>power/USB module</b> <b>Does not allow linking to other units or tables.</b> SSU armcap option - <b>Add \$49 list upcharge</b>	3.5	29	25.25	-	-	-	-	-	-	-	-	
	COM 2 3 4 5 6 7 8 9 10 11 12												
	<b>GC3641RCA</b> (metal) <b>\$894</b> <b>GC3641RCAM</b> (w/power) <b>\$2065</b>  <b>GC3641WRCA</b> (wood) <b>\$619</b> <b>GC3641WRCAM</b> (w/power) <b>\$1781</b> Specify armcap: wood or SSU.	\$916	\$937	\$965	\$1007	\$1026	\$1062	\$1122	\$1168	\$1218	\$1321	\$1432	
<b>Lounge Right End Frame, Closed Arm</b> COM Yardage: 0.75 Freight Class: 150 Product Weight (lbs.): metal: 10.17   wood: 11 Cubic Feet Per Carton: 2.1	For use in <b>right</b> side finished position of lounge seating units. • Models GC3641RCAM and GC3641WRCAM have <b>power/USB module</b> <b>Does not allow linking to other units or tables.</b> SSU armcap option - <b>Add \$49 list upcharge</b>	3.5	29	25.25	-	-	-	-	-	-	-	-	
	List Price												
	<b>GC3641LCAL</b> <b>\$1009</b> Metal  Specify armcap: wood or SSU.	OVERALL DIMENSIONS			SEAT DIMENSIONS			BACK DIMENSIONS					
<b>Lounge Left End Frame, Closed Arm, Laminate Panel</b> COM Yardage: -- Freight Class: 100 Product Weight (lbs.): 18 Cubic Feet Per Carton: 2.1	For use in <b>left</b> side finished position of lounge seating units. <b>Does not allow linking to other units or tables.</b> SSU armcap option - <b>Add \$49 list upcharge</b>	3.5	29	25.25	-	-	-	-	-	-	-	-	

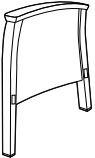

DESCRIPTION	MODEL# / FEATURES	STANDARD TEXTILE GRADES											
		List Price											
	<b>GC3641RCAL</b> Metal	<b>\$1009</b>											
	Specify armcap: wood or SSU.	<b>OVERALL DIMENSIONS</b>			<b>SEAT DIMENSIONS</b>			<b>BACK DIMENSIONS</b>					
		<b>W</b>	<b>D</b>	<b>H</b>	<b>W</b>	<b>D</b>	<b>H</b>	<b>W</b>	<b>H</b>				
<b>Lounge Right End Frame, Closed Arm, Laminate Panel</b> COM Yardage: -- Freight Class: 100 Product Weight (lbs.): 18 Cubic Feet Per Carton: 2.1	For use in <b>right</b> side finished position of lounge seating units.  <b>Does not allow linking to other units or tables.</b> SSU armcap option - <b>Add \$49 list upcharge</b>	3.5	29	25.25									
		List price											
	<b>GC36406LA</b> (metal)	<b>\$710</b>											
	<b>GC36406WLA</b> (wood)	<b>\$478</b>											
Specify armcap: wood or SSU.	<b>OVERALL DIMENSIONS</b>			<b>SEAT DIMENSIONS</b>			<b>BACK DIMENSIONS</b>						
		<b>W</b>	<b>D</b>	<b>H</b>	<b>W</b>	<b>D</b>	<b>H</b>	<b>W</b>	<b>H</b>				
<b>Lounge Center Frame, Open Arm</b> COM Yardage: -- Freight Class: 300 Product Weight (lbs.): metal: 2.24   wood: 11 Cubic Feet Per Carton: 2.1	For linking lounge top seating units together only.  SSU armcap option - <b>Add \$49 list upcharge</b>	3.5	29	25.25	-	-	-	-	-				
		COM	2	3	4	5	6	7	8	9	10	11	12
	<b>GC36406LCA</b> (metal)	<b>\$904</b>	<b>\$926</b>	<b>\$948</b>	<b>\$976</b>	<b>\$1018</b>	<b>\$1037</b>	<b>\$1073</b>	<b>\$1134</b>	<b>\$1181</b>	<b>\$1232</b>	<b>\$1336</b>	<b>\$1447</b>
	<b>GC36406WLCA</b> (wood)	<b>\$619</b>	<b>\$649</b>	<b>\$677</b>	<b>\$715</b>	<b>\$771</b>	<b>\$796</b>	<b>\$846</b>	<b>\$924</b>	<b>\$988</b>	<b>\$1054</b>	<b>\$1194</b>	<b>\$1344</b>
Specify armcap: wood or SSU.	<b>OVERALL DIMENSIONS</b>			<b>SEAT DIMENSIONS</b>			<b>BACK DIMENSIONS</b>						
		<b>W</b>	<b>D</b>	<b>H</b>	<b>W</b>	<b>D</b>	<b>H</b>	<b>W</b>	<b>H</b>				
<b>Lounge Center Frame, Closed Arm</b> COM Yardage: 0.75 Freight Class: 150 Product Weight (lbs.): metal: 8.87   wood: 11 Cubic Feet Per Carton: 2.1	For linking lounge top seating units together only.  SSU armcap option - <b>Add \$49 list upcharge</b>	3.5	29	25.25	-	-	-	-	-				
		List price											
	<b>GC36406TLA</b> (metal)	<b>\$710</b>											
	<b>GC36406WTLA</b> (wood)	<b>\$478</b>											
Specify armcap: wood or SSU.	<b>OVERALL DIMENSIONS</b>			<b>SEAT DIMENSIONS</b>			<b>BACK DIMENSIONS</b>						
		<b>W</b>	<b>D</b>	<b>H</b>	<b>W</b>	<b>D</b>	<b>H</b>	<b>W</b>	<b>H</b>				
<b>Lounge Center Frame, Open Arm</b> COM Yardage: -- Freight Class: 300 Product Weight (lbs.): metal: 11   wood: 11 Cubic Feet Per Carton: 2.1	For linking lounge top seating units to modular table on the <b>left</b> side of the frame.  SSU armcap option - <b>Add \$49 list upcharge</b>	3.5	29	25.25	-	-	-	-	-				
		List price											
	<b>GC36406TRA</b> (metal)	<b>\$710</b>											
	<b>GC36406WTRA</b> (wood)	<b>\$478</b>											
Specify armcap: wood or SSU.	<b>OVERALL DIMENSIONS</b>			<b>SEAT DIMENSIONS</b>			<b>BACK DIMENSIONS</b>						
		<b>W</b>	<b>D</b>	<b>H</b>	<b>W</b>	<b>D</b>	<b>H</b>	<b>W</b>	<b>H</b>				
<b>Lounge Center Frame, Open Arm</b> COM Yardage: -- Freight Class: 300 Product Weight (lbs.): metal: 11   wood: 11 Cubic Feet Per Carton: 2.1	For linking lounge top seating units to modular table on the <b>right</b> side of the frame.  SSU armcap option - <b>Add \$49 list upcharge</b>	3.5	29	25.25	-	-	-	-	-				

DESCRIPTION	MODEL# / FEATURES	STANDARD TEXTILE GRADES											
		COM	2	3	4	5	6	7	8	9	10	11	12
 <p><b>Lounge Center Frame, Closed Arm</b> COM Yardage: 0.75 Freight Class: 150 Product Weight (lbs.): metal: 8.87   wood: 11 Cubic Feet Per Carton: 2.1</p>	GC36406TLCA (metal)	\$904	\$926	\$948	\$976	\$1018	\$1037	\$1073	\$1134	\$1181	\$1232	\$1336	\$1447
	GC36406WTLCA (wood)	\$619	\$649	\$677	\$715	\$771	\$796	\$846	\$924	\$988	\$1054	\$1194	\$1344
	Specify armcap: wood or SSU.	OVERALL DIMENSIONS			SEAT DIMENSIONS			BACK DIMENSIONS					
		W	D	H	W	D	H	W	H				
	3.5	29	25.25	-	-	-	-	-					
	SSU armcap option - Add \$49 list upcharge												
 <p><b>Lounge Center Frame, Closed Arm</b> COM Yardage: 0.75 Freight Class: 150 Product Weight (lbs.): metal: 8.87   wood: 11 Cubic Feet Per Carton: 2.1</p>	GC36406TRCA (metal)	\$904	\$926	\$948	\$976	\$1018	\$1037	\$1073	\$1134	\$1181	\$1232	\$1336	\$1447
	GC36406WTRCA (wood)	\$619	\$649	\$677	\$715	\$771	\$796	\$846	\$924	\$988	\$1054	\$1194	\$1344
	Specify armcap: wood or SSU.	OVERALL DIMENSIONS			SEAT DIMENSIONS			BACK DIMENSIONS					
		W	D	H	W	D	H	W	H				
	3.5	29	25.25	-	-	-	-	-					
	SSU armcap option - Add \$49 list upcharge												
 <p><b>Center Frame, Fully Upholstered Arm</b> COM Yardage: 1.75 Freight Class: 150 Product Weight (lbs.): 35 Cubic Feet Per Carton: 6</p>	GC3676CFA	\$571	\$625	\$671	\$740	\$834	\$880	\$965	\$1101	\$1210	\$1325	\$1569	\$1826
	Specify leg finish: wood or SSU.	OVERALL DIMENSIONS			SEAT DIMENSIONS			BACK DIMENSIONS					
	Optional wood or SSU armcap. Please specify. Add \$190.	W	D	H	W	D	H	W	H				
		5	29	25.25	-	-	-	-	-				
	For linking lounge top seating units together or to modular table.												
	SSU armcap option - Add \$49 list upcharge												
 <p><b>Left End Frame, Fully Upholstered Arm</b> COM Yardage: 1.75 Freight Class: 250 Product Weight (lbs.): 20 Cubic Feet Per Carton: 6</p>	GC3676LA	\$571	\$625	\$671	\$740	\$834	\$880	\$965	\$1101	\$1210	\$1325	\$1569	\$1826
	Specify leg finish: wood or SSU.	OVERALL DIMENSIONS			SEAT DIMENSIONS			BACK DIMENSIONS					
	Optional wood or SSU armcap. Please specify. Add \$190.	W	D	H	W	D	H	W	H				
		5	29	25.25	-	-	-	-	-				
	For use in left side finished position of lounge seating units. <b>Does not allow linking to other units or tables.</b>												
 <p><b>Right End Frame, Fully Upholstered Arm</b> COM Yardage: 1.75 Freight Class: 250 Product Weight (lbs.): 20 Cubic Feet Per Carton: 6</p>	GC3676RA	\$571	\$625	\$671	\$740	\$834	\$880	\$965	\$1101	\$1210	\$1325	\$1569	\$1826
	Specify leg finish: wood or SSU.	OVERALL DIMENSIONS			SEAT DIMENSIONS			BACK DIMENSIONS					
	Optional wood or SSU armcap. Please specify. Add \$190.	W	D	H	W	D	H	W	H				
		5	29	25.25	-	-	-	-	-				
	For use in right side finished position of lounge seating units. <b>Does not allow linking to other units or tables.</b>												

**Modular tables for use with modular lounge and fully upholstered lounge units:**

Tops are 1" thick.

**Wooden leg tables:**

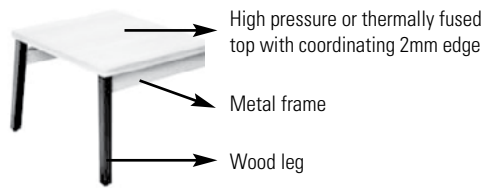

**Metal leg tables:**

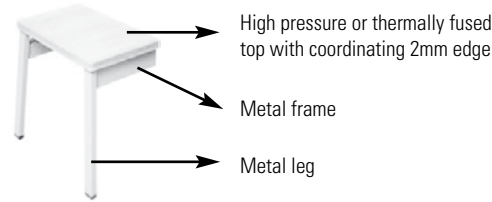

**Table top finishes:**

**Thermally Fused Laminate (LP)**

- Absolute Acajou (ACJ)
- Asian Night (ASN)
- Avant Cherry (AWC)
- Avant Honey (AWH)
- Brushed Cobalt (BRC)
- Clear Maple (CMB)
- Dark Espresso (DES)
- Designer White (DWT)
- Hayden Grey (HGT)
- Noce Biondo (NBL)
- Noce Grigio (NGL)
- Noce Leggero (NEL)
- Noce Medio (NML)
- Quartered Mahogany (QTM)
- Tiger Fruitwood (TFW)
- Tiger Walnut (TWL)
- Walnut Heights (WHE)
- White Chocolate (WHC)
- Winter Cherry (WCR)

**High Pressure Laminate (HP)**

- Absolute Acajou (ACJ)
- Asian Night (ASN)
- Avant Cherry (W357)
- Avant Honey (W356)
- Brushed Cobalt (BRC)
- Clear Maple (CMB)
- Dark Espresso (W142)
- Designer White (DWT)
- Hayden Grey (HGT)
- Noce Biondo (NBL)
- Noce Grigio (NGL)
- Noce Leggero (NEL)
- Noce Medio (NML)
- Quartered Mahogany (QTM)
- Tiger Fruitwood (TFW)
- Tiger Walnut (W819)
- Walnut Heights (WHE)
- White Chocolate (WHC)
- Winter Cherry (WCR)

**Wooden leg finishes (top, base, legs & apron):**

- |                       |                      |                     |
|-----------------------|----------------------|---------------------|
| Absolute (AAM)        | Jet Onyx (JOM)       | Noce Medio (NMM)    |
| Charcoal Java (CJM)   | Light Honey (LHM)    | Sandy Beach (SBM)   |
| Cherry (ACM)          | Mahogany (TMM)       | Shaker Cherry (SKM) |
| Empire Mahogany (EMM) | Maple (AVM)          | Silver Oak (SOM)    |
| English Oak (EOM)     | Medium Walnut (MWM)  | Walnut (TWM)        |
| Espresso Cafe (ECM)   | Natural Walnut (NLW) | White (WHM)         |
| Fruitwood (TFM)       | Night (ASM)          | WC Cream (WTM)      |
| Gray (HGM)            | Noce Biondo (NBM)    | Winter Cherry (WCM) |
| Harvest Oak (HOM)     | Noce Grigio (NGM)    |                     |
| Honey (AHM)           | Noce Leggero (NEM)   |                     |

**Metal leg finishes:**

Black (BLK), Latte (LAB), Kalua (KAL), Mocha (J52), Shadow (SHW), Toast (TOA) and Tungsten (TUN). Please specify.

**Metal frame finishes:**

Black (BLK), Latte (LAB), Kalua (KAL), Mocha (J52), Shadow (SHW), Toast (TOA) and Tungsten (TUN). Please specify.

**Power/USB modules:**



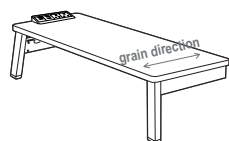



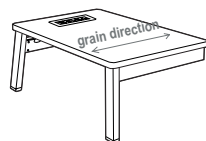

For modular tables with power/USB module, refer to models ending in "M". Module includes two power outlets, four USB charging ports and a 6 foot long power cord. Available in Black or White (must be specified at time of order). Power module is mounted **on surface** on narrow tables; mounted **in surface** on larger tables.



On surface power module on narrow tables



In surface power module on larger tables

MODULAR TABLES	MODEL#	DIMENSIONS	FREIGHT CLASS	WT/LBS.	CUBIC FT.	LIST PRICE
	GC36401-LP	<sup>D x W x H</sup> 28 x 20.25 x 13	125	23	3.5	<b>\$981</b>
	GC36401M-LP With power					<b>\$2074</b>
	GC36401-HP	28 x 20.25 x 13	125	23	3.5	<b>\$1023</b>
	GC36401M-HP With power					<b>\$2118</b>
<b>Center Table</b>	<p>Coordinating 2mm edge. Regular center table for <b>wood or metal lounge</b> frame. Must be connected to full arm and leg with <b>lounge</b> frames (GC36406TLA/TRA, GC36406TLCA/TRCA, GC36406WTLA/TRA, GC36406WTLCA/TRCA). 1 per carton.</p>					
	GC36402-LP	28 x 12 x 13	100	20	2.1	<b>\$936</b>
	GC36402M-LP With power					<b>\$2032</b>
	GC36402-HP	28 x 12 x 13	100	20	2.1	<b>\$981</b>
	GC36402M-HP With power					<b>\$2074</b>
<b>Narrow Center Table</b>	<p>Coordinating 2mm edge. Narrow center table for <b>wood or metal lounge</b> frame. Must be connected to full arm and leg with <b>lounge</b> frames (GC36406TLA/TRA, GC36406TLCA/TRCA, GC36406WTLA/TRA, GC36406TLCA/TRCA). 1 per carton.</p>					
	GC36403WL-LP	37.12 x 37.12 x 13	125	46	6	<b>\$1674</b>
	GC36403WLM-LP With power					<b>\$2771</b>
	GC36403WL-HP	37.12 x 37.12 x 13	125	46	6	<b>\$1773</b>
	GC36403WLM-HP With power					<b>\$2868</b>
<b>Left Corner Table, Wood Legs</b>	<p>Coordinating 2mm edge. Must be connected to full arm and leg with <b>wood lounge</b> frames (GC36406WTLA/TRA, GC36406WTLCA/TRCA). This table allows for kneespace when specifying chairs in a corner position. 1 per carton.</p> <ul style="list-style-type: none"> <li>Includes 2 rear wood legs (not shown).</li> </ul>					
	GC36403L-LP	37.12 x 37.12 x 13	125	46	6	<b>\$1761</b>
	GC36403LM-LP With power					<b>\$2854</b>
	GC36403L-HP	37.12 x 37.12 x 13	125	46	6	<b>\$1860</b>
	GC36403LM-HP With power					<b>\$2955</b>
<b>Left Corner Table, Metal Legs</b>	<p>Coordinating 2mm edge. Must be connected to full arm and leg with <b>metal lounge</b> frames (GC36406TLA/TRA, GC36406TLCA/TRCA). This table allows for kneespace when specifying chairs in a corner position. 1 per carton.</p> <ul style="list-style-type: none"> <li>Includes 2 rear metal legs (not shown).</li> </ul>					

- For a thermally fused laminate top (LP), specify model GC36401-LP.
- For a high pressure laminate top (HP), specify model GC36401-HP.

- Models GC36401M-LP and GC36401M-HP have **power/USB** module mounted in surface.

- For a thermally fused laminate top (LP), specify model GC36402-LP.
- For a high pressure laminate top (HP), specify model GC36402-HP.

- Models GC36402M-LP and GC36402M-HP have **power/USB** module mounted in surface.

- For a thermally fused laminate top (LP), specify model GC36403WL-LP.
- For a high pressure laminate top (HP), specify model GC36403WL-HP.

- Models GC36403WLM-LP and GC36403WLM-HP have **power/USB** module mounted in surface.

- For a thermally fused laminate top (LP), specify model GC36403L-LP.
- For a high pressure laminate top (HP), specify model GC36403L-HP.

- Models GC36403LM-LP and GC36403LM-HP have **power/USB** module mounted in surface.

MODULAR TABLES

MODEL# DIMENSIONS FREIGHT CLASS WT/LBS. CUBIC FT. LIST PRICE



Right Corner Table, Wood Legs



Right Corner Table, Metal Legs

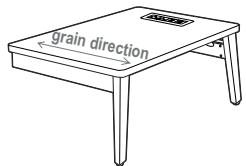
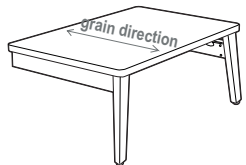

Left End Table, Wood Legs

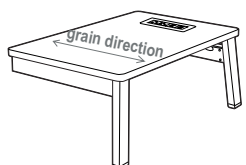
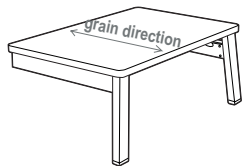

Left End Table, Metal Legs

D x W x H						
GC36403WR-LP	37.12 x 37.12 x 13	125	46	6		\$1674
GC36403WRM-LP						\$2771
With power						

GC36403WR-HP	37.12 x 37.12 x 13	125	46	6		\$1773
GC36403WRM-HP						\$2868
With power						

- For a thermally fused laminate top (LP), specify model GC36403WR-LP.
- For a high pressure laminate top (HP), specify model GC36403WR-HP.

- Models GC36403WRM-LP and GC36403WRM-HP have **power/USB** module mounted in surface.

Coordinating 2mm edge. Must be connected to full arm and leg with **wood lounge** frames (GC36406WTLA/TRA, GC36406WTLCA/TRCA). This table allows for kneespace when specifying chairs in a corner position. 1 per carton.

- Includes 2 rear wood legs (not shown).

GC36403R-LP	37.12 x 37.12 x 13	125	46	6		\$1761
GC36403RM-LP						\$2854
With power						

GC36403R-HP	37.12 x 37.12 x 13	125	46	6		\$1860
GC36403RM-HP						\$2955
With power						

- For a thermally fused laminate top (LP), specify model GC36403R-LP.
- For a high pressure laminate top (HP), specify model GC36403R-HP.

- Models GC36403RM-LP and GC36403RM-HP have **power/USB** module mounted in surface.

Coordinating 2mm edge. Must be connected to full arm and leg with **metal lounge** frames (GC36406TLA/TRA, GC36406TLCA/TRCA). This table allows for kneespace when specifying chairs in a corner position. 1 per carton.

- Includes 2 rear metal legs (not shown).

GC36404WL-LP	28 x 20.25 x 13	125	23	3.5		\$1311
GC36404WLM-LP						\$2407
With power						

GC36404WL-HP	28 x 20.25 x 13	125	23	3.5		\$1362
GC36404WLM-HP						\$2457
With power						

- For a thermally fused laminate top (LP), specify model GC36404WL-LP.
- For a high pressure laminate top (HP), specify model GC36404WL-HP.

- Models GC36404WLM-LP and GC36404WLM-HP have **power/USB** module mounted in surface.

Coordinating 2mm edge. Must be connected to full arm and leg with **wood lounge** frames (GC36406WTLA or GC36406WTLCA). 1 per carton.



GC36404L-LP	28 x 20.25 x 13	125	23	3.5		\$1399
GC36404LM-LP						\$2492
With power						

GC36404L-HP	28 x 20.25 x 13	125	23	3.5		\$1447
GC36404LM-HP						\$2541
With power						

- For a thermally fused laminate top (LP), specify model GC36404L-LP.
- For a high pressure laminate top (HP), specify model GC36404L-HP.

- Models GC36404LM-LP and GC36404LM-HP have **power/USB** module mounted in surface.

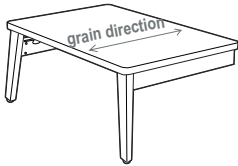
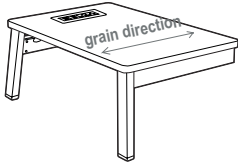
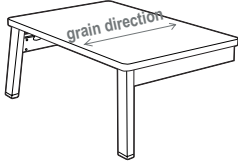
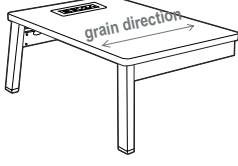
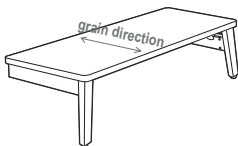
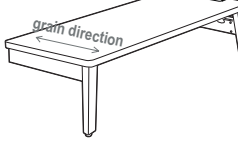
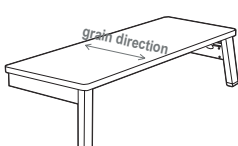
Coordinating 2mm edge. Must be connected to full arm and leg with **metal lounge** frames (GC36406TLA or GC36406TLCA). 1 per carton.

MODULAR TABLES	MODEL#	DIMENSIONS D x W x H	FREIGHT CLASS	WT/LBS.	CUBIC FT.	LIST PRICE
	GC36404WR-LP	28 x 20.25 x 13	125	23	3.5	<b>\$1311</b>
	GC36404WRM-LP With power					<b>\$2407</b>
	GC36404WR-HP	28 x 20.25 x 13	125	23	3.5	<b>\$1362</b>
	GC36404WRM-HP With power					<b>\$2457</b>
<ul style="list-style-type: none"> <li>• For a thermally fused laminate top (LP), specify model GC36404WR-LP.</li> <li>• For a high pressure laminate top (HP), specify model GC36404WR-HP.</li> <li>• Models GC36404WRM-LP and GC36404WRM-HP have <b>power/USB</b> module mounted in surface.</li> </ul> <p>Coordinating 2mm edge. Must be connected to full arm and leg with <b>wood lounge</b> frames (GC36406WTRA or GC36406WTRCA). 1 per carton.</p>						
	GC36404R-LP	28 x 20.25 x 13	125	23	3.5	<b>\$1399</b>
	GC36404RM-LP With power					<b>\$2492</b>
	GC36404R-HP	28 x 20.25 x 13	125	23	3.5	<b>\$1447</b>
	GC36404RM-HP With power					<b>\$2541</b>
<ul style="list-style-type: none"> <li>• For a thermally fused laminate top (LP), specify model GC36404R-LP.</li> <li>• For a high pressure laminate top (HP), specify model GC36404R-HP.</li> <li>• Models GC36404RM-LP and GC36404RM-HP have <b>power/USB</b> module mounted in surface.</li> </ul> <p>Coordinating 2mm edge. Must be connected to full arm and leg with <b>metal lounge</b> frames (GC36406TRA or GC36406TRCA). 1 per carton.</p>						
	GC36405WL-LP	28 x 12 x 13	100	20	2.1	<b>\$1257</b>
	GC36405WLM-LP With power					<b>\$2350</b>
	GC36405WL-HP	28 x 12 x 13	100	20	2.1	<b>\$1300</b>
	GC36405WLM-HP With power					<b>\$2393</b>
<ul style="list-style-type: none"> <li>• For a thermally fused laminate top (LP), specify model GC36405WL-LP.</li> <li>• For a high pressure laminate top (HP), specify model GC36405WL-HP.</li> <li>• Models GC36405WLM-LP and GC36405WLM-HP have <b>power/USB</b> module mounted on surface.</li> </ul> <p>Coordinating 2mm edge. Must be connected to full arm and leg with <b>wood lounge</b> frames (GC36406WTLA or GC36406WTLCA). 1 per carton.</p>						
	GC36405L-LP	28 x 12 x 13	100	20	2.1	<b>\$1341</b>
	GC36405LM-LP With power					<b>\$2437</b>
	GC36405L-HP	28 x 12 x 13	100	20	2.1	<b>\$1386</b>
	GC36405LM-HP With power					<b>\$2481</b>
<ul style="list-style-type: none"> <li>• For a thermally fused laminate top (LP), specify model GC36405L-LP.</li> <li>• For a high pressure laminate top (HP), specify model GC36405L-HP.</li> <li>• Models GC36405LM-LP and GC36405LM-HP have <b>power/USB</b> module mounted on surface.</li> </ul> <p>Coordinating 2mm edge. Must be connected to full arm and leg with <b>metal lounge</b> frames (GC36406TLA or GC36406TLCA). 1 per carton.</p>						

MODULAR TABLES	MODEL#	DIMENSIONS	FREIGHT CLASS	WT/LBS.	CUBIC FT.	LIST PRICE
----------------	--------	------------	---------------	---------	-----------	------------

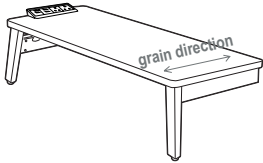

**Narrow Right End Table, Wood Legs**

	D x W x H					
GC36405WR-LP	28 x 12 x 13	100	20	2.1	<b>\$1257</b>	
GC36405WRM-LP					<b>\$2350</b>	
With power						

GC36405WR-HP	28 x 12 x 13	100	20	2.1	<b>\$1300</b>	
GC36405WRM-HP					<b>\$2393</b>	
With power						

- For a thermally fused laminate top (LP), specify model GC36405WR-LP.
- For a high pressure laminate top (HP), specify model GC36405WR-HP.
- Models GC36405WRM-LP and GC36405WRM-HP have **power/USB** module mounted on surface.

Coordinating 2mm edge. Must be connected to full arm and leg with **wood lounge** frames (GC36406WTRA or GC36406WTRCA). 1 per carton.

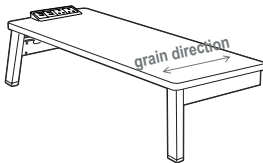
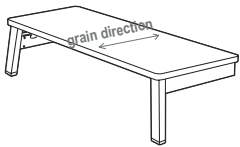

**Narrow Right End Table, Metal Legs**

GC36405R-LP	28 x 12 x 13	100	20	2.1	<b>\$1341</b>	
GC36405RM-LP					<b>\$2437</b>	
With power						

GC36405R-HP	28 x 12 x 13	100	20	2.1	<b>\$1386</b>	
GC36405RM-HP					<b>\$2481</b>	
With power						

- For a thermally fused laminate top (LP), specify model GC36405R-LP.
- For a high pressure laminate top (HP), specify model GC36405R-HP.
- Models GC36405RM-LP and GC36405RM-HP have **power/USB** module mounted on surface.

Coordinating 2mm edge. Must be connected to full arm and leg with **metal lounge** frames (GC36406TRA or GC36406TRCA). 1 per carton.

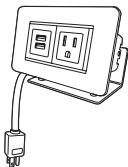

**On Surface Power/Data Module**

GC36410	-- x -- x --	250	2	1	<b>\$680</b>	
---------	--------------	-----	---	---	--------------	--

Surface top mount power/data module with one power outlet, two USB charging ports. 6 foot cord. White. Can be mounted to all freestanding and modular tables.





Meet River+™, the next generation of our highly popular River lounge series. Now with industry-leading support for workplace, education and healthcare, River+ performs at three times the BIFMA standard for true 24/7 applications in demanding environments. All models have been active weight tested to 600 lbs. including bariatric use. Multiple back and seat heights, 120-degree configurations and modular Aluminum arms are just a few of the many options that will make it yours.

To see the full River+ series, please refer to the Seating price list at: [globalfurnituregroup.com/workplace/resources/price-lists](http://globalfurnituregroup.com/workplace/resources/price-lists)

#### Features and Benefits

- A modular series that is composed of straight, curved and corner lounge sections, a wide assortment of benches and tables, and media hearths.
- Lounge and linking tables can be linked together in any combination to create a wide variety of layouts. Ganging hardware is standard and is factory installed. Ganging hardware swivels out of the way when not in use.
- Seating frames are constructed of heavy duty plywood, and are made for active environments. Seats are high density with highly resilient foam.
- River+ seating is rated for an active weight up to 600 lbs. per seat and 24/7 use.
- For 24/7 use and/or heavy duty application use, Global's Heavy Duty warranty is only on models specified with performance textiles, rated for 150,000 double rubs or more.
- A clean-out gap is created by seat-to-back connector brackets available in three finishes.
- The tapered legs are made of welded steel. The standard leg height is 6.5" with optional 3" and 8" legs available on select models. The leg height makes it easy to clean under the product.
- Modular, polished Aluminum loop arms can be relocated and retrofit to support changing layouts.
- A back shelf is available on most units in many laminate finishes.
- For improved safety, housekeeping and infection control, optional features include: sealed seams, sealed seat underside, and tamperproof bottom enclosures.
- For easy user access, optional power units are available for specification in a variety of locations across most River+ lounges, benches, and tables.
- For environmental certifications, please visit [globalfurnituregroup.com](http://globalfurnituregroup.com).



## SENATOR



model GC3392



## STANDARD FEATURES

- The flared back design and creative curves enhance any healthcare environment without sacrificing comfort.
- Waterfall seamless front upholstered design with removable seat cushions for easy cleaning and protecting against bacteria.
- For added comfort, seats are standard with high density foam.
- Standard with wood legs.
- For healthcare textiles and wood finish options, visit the website at [globalfurnituregroup.com](http://globalfurnituregroup.com).
- Can be upholstered in standard Global textiles if healthcare compliance is not required.
- Shipped fully assembled.

## OPTIONAL FEATURES

- Optional metal legs are available in Black (BLK), Latte (LAB), Kalua (KAL), Mocha (J52), Shadow (SHW), Toast (TOA) and Tungsten (TUN). Please specify. No upcharge.
- For non-slip glides specify **(NS)** - Add \$32.
- For moisture barrier on seat, please specify **(MB)**. Add \$178 per seat.

## SUGGESTED APPLICATIONS

- Lobbies
- Lounge/Waiting
- Patient rooms
- Resident rooms

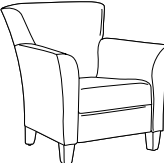
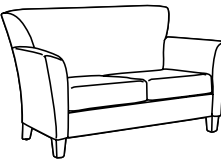
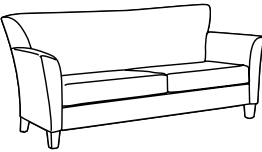
DESCRIPTION	MODEL# / FEATURES	STANDARD TEXTILE GRADES											
		COM	2	3	4	5	6	7	8	9	10	11	12
 <p><b>Armchair</b> COM Yardage: 5.25 Freight Class: 250 Product Weight (lbs.): 66 Cubic Feet Per Carton: 28.5</p>	GC3391	\$2514	\$2660	\$2921	\$3118	\$3400	\$3506	\$3753	\$4213	\$4446	\$4875	\$5471	\$6206
	Active weight 300lbs.	OVERALL DIMENSIONS			SEAT DIMENSIONS			BACK DIMENSIONS					
		W	D	H	W	D	H	W	H				
		34	32.25	36	19.5	19	17.5	28	18.5				
 <p><b>Two Seat Sofa</b> COM Yardage: 8.25 Freight Class: 300 Product Weight (lbs.): 100 Cubic Feet Per Carton: 55.75</p>	GC3392	\$3536	\$3771	\$4161	\$4470	\$4913	\$5078	\$5466	\$6191	\$6554	\$7231	\$8170	\$9324
	Active weight 300lbs./seat.	OVERALL DIMENSIONS			SEAT DIMENSIONS			BACK DIMENSIONS					
		W	D	H	W	D	H	W	H				
		61	32.25	36	46	19	17.5	56	18.5				
 <p><b>Three Seat Sofa</b> COM Yardage: 9.5 Freight Class: 250 Product Weight (lbs.): 125 Cubic Feet Per Carton: 62.25</p>	GC3393	\$4566	\$4831	\$5305	\$5665	\$6171	\$6365	\$6808	\$7645	\$8063	\$8841	\$9921	\$11255
	Active weight 300lbs./seat.	OVERALL DIMENSIONS			SEAT DIMENSIONS			BACK DIMENSIONS					
		W	D	H	W	D	H	W	H				
		76	32.25	36	61	19	17.5	71	18.5				

**SLEEP-EEZ**



model GC3614

**STANDARD FEATURES**

- Sleep-Eez provides incredible comfort, requires zero wall clearance and can be easily opened and closed by one person.
- It can be adjusted to create three functional positions: a chair, a chaise lounge and a sleep surface.
- The heavy duty steel mechanism will provide long-term performance.
- Commercial grade casters are standard. Front casters are non-swivel manual locking. Back casters are non-locking and swivel for better steering when moving the chair.
- Clean out space is provided between the seat and back cushions for housekeeping and infection prevention control.
- Sleep-Eez's construction allows for on-site replacement of all components, eliminating down time and enhancing the product's life.
- Standard with Black self-skinned urethane (SSU) fully extended arms with a grip for ease of entry and exit from chair.
- For Globalcare textile options, visit the website at [www.globalfurnituregroup.com](http://www.globalfurnituregroup.com).
- Can be upholstered in standard Global textiles if healthcare compliance is not required.
- Ships fully assembled.
- Measurements:  
Chair: 34.5"W x 37"D x 34.25"H  
Chaise lounge: 34.5"W x 64"D x 34.25"H  
Sleep surface: 24"W x 77"D

**OPTIONAL FEATURES**

- For moisture barrier on seat, please specify **(MB)**. Add \$178.
- To add sealed seams to your product, please specify **(SS)**. Add \$317.

**SUGGESTED APPLICATIONS**

- Lobbies
- Lounge/Waiting
- Office/Meeting
- Patient rooms
- Resident rooms
- Treatment/Exam rooms

Please add option codes in the following order:

- **Model number**  
**GC3614** Single sleeper chair
- **Textile**  
Specify fabric code.
- **Armcap finish**  
**(SS)** Black SSU armcap  
**(KL)** Kalua SSU armcap  
**(LT)** Latte SSU armcap  
**(MC)** Mocha SSU armcap  
**(SW)** Shadow SSU armcap  
**(TO)** Toast SSU armcap  
**(AB)** Absolute wood armcap  
**(CJ)** Charcoal Java wood armcap  
**(AC)** Cherry wood armcap  
**(EP)** Empire Mahogany wood armcap  
**(EM)** English Oak wood armcap  
**(EC)** Espresso Cafe wood armcap  
**(HG)** Gray wood armcap  
**(HA)** Harvest Oak wood armcap  
**(AH)** Honey wood armcap  
**(JO)** Jet Onyx wood armcap  
**(LH)** Light Honey wood armcap  
**(AV)** Maple wood armcap  
**(MW)** Medium Walnut wood armcap  
**(NL)** Natural Walnut wood armcap  
**(AT)** Night wood armcap  
**(BI)** Noce Biondo wood armcap  
**(GI)** Noce Grigio wood armcap  
**(EI)** Noce Leggero wood armcap  
**(MI)** Noce Medio wood armcap  
**(SB)** Sandy Beach wood armcap  
**(SK)** Shaker Cherry wood armcap  
**(SM)** Silver Oak wood armcap  
**(TF)** Tiger Fruitwood wood armcap  
**(TM)** Tiger Mahogany wood armcap  
**(TL)** Tiger Walnut wood armcap  
**(WR)** WC Cream wood armcap  
**(WH)** White wood armcap  
**(WC)** Winter Cherry wood armcap
- **Moisture Barrier**  
**(MB)** Seat only
- **Sealed Seams**  
**(SS)** All sealed seams

**EXAMPLE SLEEP-EEZ ORDER CODE:**

GC3614	-LX21	-PT	-MB	-SS
Model #	Textile	Armcaps	Moisture Barrier	Sealed Seams

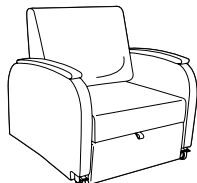
DESCRIPTION	MODEL#	STANDARD TEXTILE GRADES											
		COM	2	3	4	5	6	7	8	9	10	11	12
 <p><b>Single Sleeper Chair</b> COM Yardage: 8.5 Freight Class: 150 Product weight (lbs.): 160 Cubic Feet per Carton: 38</p>	GC3614	\$4617	\$4889	\$5110	\$5438	\$5906	\$6122	\$6546	\$7218	\$7741	\$8316	\$9503	\$10770
	Active weight 350 lbs.	<b>OVERALL DIMENSIONS</b>			<b>SEAT DIMENSIONS</b>			<b>BACK DIMENSIONS</b>					
		W	D	H	W	D	H	W	H				
		35	37	35	27.5	21	17.5	27.5	18.5				

**STRAND**



model GC3707HB



model GC3702

**FEATURES**

- Strand is the perfect synthesis of versatility, comfort, durability and value pricing. Strand offers a pleasing look in a diverse range of solutions from single patient room chairs to waiting areas and public spaces.
- All models are standard in oval metal tube frame.
- Frame available in Black (BLK), Latte (LAB), Kalua (KAL), Mocha (J52), Shadow (SHW), Toast (TOA) and Tungsten (TUN). Please specify.
- The frame can be weighted and made with tamper proof fasteners for greater security in more challenging mental health spaces or correctional facilities.
- Armcaps are standard in Black self-skinned urethane (SSU).
- **Left and Right Position Reference** is determined based on being seated in the chair.
- The seat and back are removable and field replaceable.
- For added comfort, seats are standard with high density foam.
- All seat frames feature a wall saver design to prevent back contact with wall. Footstool and benches do not have wall saver legs.
- Standard seat height on all models is 18".
- Cleanout space is provided between the seat and back cushions for easy housekeeping.
- Standard with Black plastic glides.
- Select models are offered with rear tip and move wheels. To activate wheels, tilt the chair back so the casters are in contact with the floor. This feature makes it easy to relocate the chair while unoccupied.
- Flex back models allow the back to move in a soothing rocking motion.
- Active weight capacity for standard single seat is 350 lbs. and 750 lbs for bariatric seating.
- For Globalcare textiles and finish options, visit the website at [www.globalfurnituregroup.com](http://www.globalfurnituregroup.com)
- Can be upholstered in standard Global textiles if healthcare compliance is not required.



**OPTIONAL FEATURES**

- Wood armcaps are also available in all healthcare wood seating finishes.  
Single Seat - Add \$165  
Two Seater - Add \$244.  
Three Seater - Add \$326.
- Non-marking White glides are available. Please specify **(WH)**. No upcharge.
- For moisture barrier on seat, add **\$119** per seat. For bariatric models - Add **\$183** per seat.
- As an option, seams can be sealed to prevent penetration of fluids through the stitching. Contact Customer Care for approved textiles.  
For Low Back Models - Add \$75 per seat.  
For Low Back Bariatric Models - Add \$80 per seat.  
For High Back Models - Add \$87 per seat.  
For High Back Bariatric Models - Add \$90 per seat.  
For Split-Back models - Add \$131  
For Ottoman - Add \$23  
For Single Seat Bench - Add \$30  
For Two Seat Bench - Add \$59  
For Three Seat Bench - Add \$87
- For complementary tables, please refer to the GC-Belong **freestanding** tables, page 41 (*Not for use with GC-Belong table bridges.*)



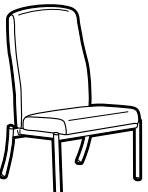

**SUGGESTED APPLICATIONS**

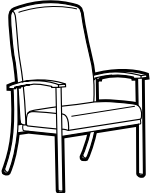
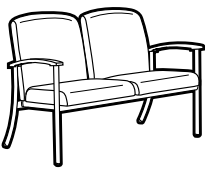
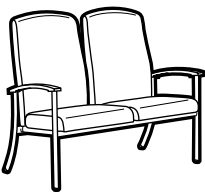
- Bariatric seating (some models)
- Guest seating
- Lobbies
- Lounge/Waiting
- Patient rooms
- Resident rooms
- Treatment/Exam rooms

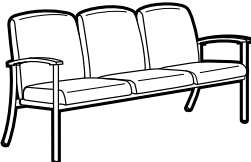
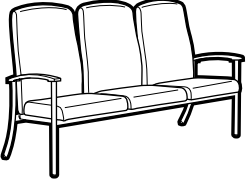
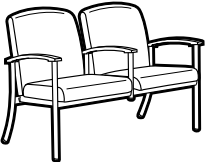
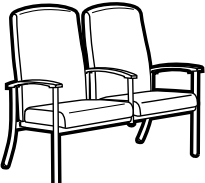
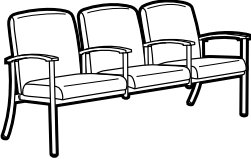
DESCRIPTION	MODEL#	STANDARD FABRIC GRADES												
		COM	2	3	4	5	6	7	8	9	10	11	12	
 <b>Low Back Single Seat Armless Chair</b> COM Yardage: 1.75 Freight Class: 250 Product Weight (lbs.): 43 Cubic Feet Per Carton: 17.5	GC3700	\$1162	\$1216	\$1262	\$1331	\$1425	\$1463	\$1546	\$1704	\$1781	\$1929	\$2131	\$2382	
	Active weight 350 lbs.	<b>OVERALL DIMENSIONS</b>			<b>SEAT DIMENSIONS</b>			<b>BACK DIMENSIONS</b>						
		<b>W</b>	<b>D</b>	<b>H</b>	<b>W</b>	<b>D</b>	<b>H</b>	<b>W</b>	<b>H</b>					
		24.5	27.5	34.5	22	18.5	18	21.5	17					
 <b>High Back Single Seat Armless Chair</b> COM Yardage: 2 Freight Class: 250 Product Weight (lbs.): 51 Cubic Feet Per Carton: 20	GC3700HB	\$1374	\$1434	\$1490	\$1567	\$1677	\$1718	\$1815	\$1994	\$2084	\$2251	\$2482	\$2768	
	Active weight 350 lbs.	<b>OVERALL DIMENSIONS</b>			<b>SEAT DIMENSIONS</b>			<b>BACK DIMENSIONS</b>						
		<b>W</b>	<b>D</b>	<b>H</b>	<b>W</b>	<b>D</b>	<b>H</b>	<b>W</b>	<b>H</b>					
		24.5	27.5	42.5	22	18	18	21.5	25					

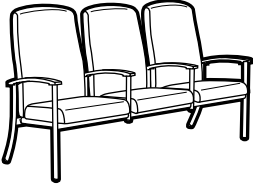
DESCRIPTION	MODEL#	STANDARD FABRIC GRADES											
		COM	2	3	4	5	6	7	8	9	10	11	12
 <p><b>LB Single Seat Armchair</b> COM Yardage: 1.75 Freight Class: 250 Product Weight (lbs.): 48 Cubic Feet Per Carton: 17.5</p>	GC3701	\$1386	\$1442	\$1488	\$1556	\$1651	\$1687	\$1772	\$1930	\$2006	\$2155	\$2356	\$2607
		<b>OVERALL DIMENSIONS</b>			<b>SEAT DIMENSIONS</b>			<b>BACK DIMENSIONS</b>					
		<b>W</b>	<b>D</b>	<b>H</b>	<b>W</b>	<b>D</b>	<b>H</b>	<b>W</b>	<b>H</b>				
		25.5	27.5	34.5	22	18.5	18	21.5	17				
<p>Active weight 350 lbs. Wood armcap option - <b>Add \$165</b></p>													
 <p><b>LB Hip Armchair, Post Surgery</b> COM Yardage: 1.75 Freight Class: 250 Product Weight (lbs.): 53 Cubic Feet Per Carton: 17.5</p> <p>Designed to immobilize the pelvis and hip joints after surgery.</p>	GC3701-24	\$1699	\$1755	\$1801	\$1871	\$1964	\$2001	\$2085	\$2243	\$2322	\$2468	\$2671	\$2923
		<b>OVERALL DIMENSIONS</b>			<b>SEAT DIMENSIONS</b>			<b>BACK DIMENSIONS</b>					
		<b>W</b>	<b>D</b>	<b>H</b>	<b>W</b>	<b>D</b>	<b>H</b>	<b>W</b>	<b>H</b>				
		25.5	27.5	40.5	22	18.5	24	21.5	17				
<p>Active weight 350 lbs. Wood armcap option - <b>Add \$165</b></p>													
 <p><b>HB Single Seat Armchair</b> COM Yardage: 2 Freight Class: 250 Product Weight (lbs.): 53 Cubic Feet Per Carton: 20</p>	GC3701HB	\$1598	\$1659	\$1712	\$1790	\$1899	\$1941	\$2036	\$2217	\$2306	\$2474	\$2705	\$2992
		<b>OVERALL DIMENSIONS</b>			<b>SEAT DIMENSIONS</b>			<b>BACK DIMENSIONS</b>					
		<b>W</b>	<b>D</b>	<b>H</b>	<b>W</b>	<b>D</b>	<b>H</b>	<b>W</b>	<b>H</b>				
		25.5	27.5	42.5	22	18	18	21.5	25				
<p>Active weight 350 lbs. Wood armcap option - <b>Add \$165</b></p>													
 <p><b>LB Two Seat Chair, No Center Arm</b> COM Yardage: 3.25 Freight Class: 300 Product Weight (lbs.): 68 Cubic Feet Per Carton: 43</p>	GC3702	\$2187	\$2289	\$2376	\$2500	\$2679	\$2746	\$2901	\$3190	\$3338	\$3611	\$3988	\$4452
		<b>OVERALL DIMENSIONS</b>			<b>SEAT DIMENSIONS</b>			<b>BACK DIMENSIONS</b>					
		<b>W</b>	<b>D</b>	<b>H</b>	<b>W</b>	<b>D</b>	<b>H</b>	<b>W</b>	<b>H</b>				
		49.75	27.5	34.5	44	18.5	18	43	17				
<p>Active weight 350 lbs./seat Wood armcap option - <b>Add \$165</b></p>													
 <p><b>HB Two Seat Chair, No Center Arm</b> COM Yardage: 3.75 Freight Class: 300 Product Weight (lbs.): 75 Cubic Feet Per Carton: 56.5</p>	GC3702HB	\$2520	\$2635	\$2735	\$2879	\$3084	\$3162	\$3340	\$3680	\$3848	\$4161	\$4595	\$5135
		<b>OVERALL DIMENSIONS</b>			<b>SEAT DIMENSIONS</b>			<b>BACK DIMENSIONS</b>					
		<b>W</b>	<b>D</b>	<b>H</b>	<b>W</b>	<b>D</b>	<b>H</b>	<b>W</b>	<b>H</b>				
		49.75	27.5	42.5	44	18.5	18	43	25				
<p>Active weight 350 lbs./seat Wood armcap option - <b>Add \$165</b></p>													

DESCRIPTION	MODEL#	STANDARD FABRIC GRADES											
		COM	2	3	4	5	6	7	8	9	10	11	12
 <p><b>LB Three Seat Chair, No Center Arms</b>                      COM Yardage: 4.5                      Freight Class: 300                      Product Weight (lbs.): 90                      Cubic Feet Per Carton: 65.25</p>	GC3703	\$3058	\$3198	\$3316	\$3489	\$3736	\$3828	\$4044	\$4447	\$4651	\$5026	\$5550	\$6196
		OVERALL DIMENSIONS			SEAT DIMENSIONS			BACK DIMENSIONS					
		W	D	H	W	D	H	W	H				
			71.25	27.5	34.5	66	18.5	18	64.5	17			
 <p><b>HB Three Seat Chair, No Center Arms</b>                      COM Yardage: 5.25                      Freight Class: 300                      Product Weight (lbs.): 96                      Cubic Feet Per Carton: 80.75</p>	GC3703HB	\$3427	\$3591	\$3729	\$3934	\$4218	\$4327	\$4579	\$5051	\$5286	\$5724	\$6334	\$7088
		OVERALL DIMENSIONS			SEAT DIMENSIONS			BACK DIMENSIONS					
		W	D	H	W	D	H	W	H				
			71.25	27.5	42.5	66	18.5	18	64.5	25			
 <p><b>LB Two Seat Chair, Half Center Arm</b>                      COM Yardage: 3.25                      Freight Class: 300                      Product Weight (lbs.): 73                      Cubic Feet Per Carton: 43</p>	GC3704	\$2419	\$2521	\$2606	\$2732	\$2908	\$2977	\$3132	\$3424	\$3569	\$3842	\$4221	\$4684
		OVERALL DIMENSIONS			SEAT DIMENSIONS			BACK DIMENSIONS					
		W	D	H	W	D	H	W	H				
			49.75	27.5	34.5	22	18.5	18	21.5	17			
 <p><b>HB Two Seat Chair, Half Center Arm</b>                      COM Yardage: 3.75                      Freight Class: 300                      Product Weight (lbs.): 79                      Cubic Feet Per Carton: 56.5</p>	GC3704HB	\$2754	\$2869	\$2968	\$3114	\$3318	\$3396	\$3574	\$3914	\$4082	\$4395	\$4829	\$5369
		OVERALL DIMENSIONS			SEAT DIMENSIONS			BACK DIMENSIONS					
		W	D	H	W	D	H	W	H				
			49.75	27.5	42.5	44	18.5	18	43	25			
 <p><b>LB Three Seat Chair, Half Center Arms</b>                      COM Yardage: 4.5                      Freight Class: 300                      Product Weight (lbs.): 100                      Cubic Feet Per Carton: 65.25</p>	GC3705	\$3519	\$3661	\$3779	\$3953	\$4200	\$4293	\$4506	\$4911	\$5115	\$5490	\$6014	\$6659
		OVERALL DIMENSIONS			SEAT DIMENSIONS			BACK DIMENSIONS					
		W	D	H	W	D	H	W	H				
			71.25	27.5	34.5	22	18.5	18	21.5	17			

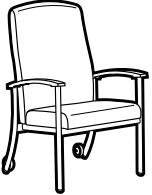
DESCRIPTION	MODEL#	STANDARD FABRIC GRADES											
		COM	2	3	4	5	6	7	8	9	10	11	12
 <p><b>HB Three Seat Chair, Half Center Arms</b>                      COM Yardage: 5.25                      Freight Class: 300                      Product Weight (lbs.): 100                      Cubic Feet Per Carton: 80.75</p>	GC3705HB	\$3889	\$4055	\$4193	\$4395	\$4681	\$4791	\$5043	\$5514	\$5749	\$6189	\$6798	\$7549
		<b>OVERALL DIMENSIONS</b>			<b>SEAT DIMENSIONS</b>			<b>BACK DIMENSIONS</b>					
		W	D	H	W	D	H	W	H				
			71.25	27.5	42.5	66	18.5	18	64.5	25			
<p>Active weight 350 lbs./seat                      Wood armcap option - <b>Add \$326</b></p>													
 <p><b>LB Armless Chair, Rear Tip &amp; Move Wheels</b>                      COM Yardage: 1.75                      Freight Class: 250                      Product Weight (lbs.): 43                      Cubic Feet Per Carton: 17.5</p>	GC3706	\$1303	\$1357	\$1405	\$1473	\$1567	\$1604	\$1687	\$1845	\$1925	\$2070	\$2274	\$2525
		<b>OVERALL DIMENSIONS</b>			<b>SEAT DIMENSIONS</b>			<b>BACK DIMENSIONS</b>					
		W	D	H	W	D	H	W	H				
			24.5	27.5	34.5	22	18.5	18	21.5	17			
<p>Active weight 350 lbs.</p>													
 <p><b>HB Armless Chair, Rear Tip &amp; Move Wheels</b>                      COM Yardage: 2                      Freight Class: 250                      Product Weight (lbs.): 53                      Cubic Feet Per Carton: 20</p>	GC3706HB	\$1516	\$1576	\$1629	\$1709	\$1818	\$1858	\$1954	\$2134	\$2224	\$2392	\$2624	\$2909
		<b>OVERALL DIMENSIONS</b>			<b>SEAT DIMENSIONS</b>			<b>BACK DIMENSIONS</b>					
		W	D	H	W	D	H	W	H				
			24.5	27.5	42.5	22	18	18	21.5	25			
<p>Active weight 350 lbs.</p>													
 <p><b>LB Armchair, Rear Tip &amp; Move Wheels</b>                      COM Yardage: 1.75                      Freight Class: 250                      Product Weight (lbs.): 48                      Cubic Feet Per Carton: 17.5</p>	GC3707	\$1530	\$1584	\$1632	\$1699	\$1794	\$1831	\$1915	\$2074	\$2152	\$2298	\$2501	\$2750
		<b>OVERALL DIMENSIONS</b>			<b>SEAT DIMENSIONS</b>			<b>BACK DIMENSIONS</b>					
		W	D	H	W	D	H	W	H				
			25.5	27.5	34.5	22	18.5	18	21.5	17			
<p>Active weight 350 lbs.                      Wood armcap option - <b>Add \$165</b></p>													
 <p><b>HB Armchair, Rear Tip &amp; Move Wheels</b>                      COM Yardage: 2                      Freight Class: 250                      Product Weight (lbs.): 50                      Cubic Feet Per Carton: 20</p>	GC3707HB	\$1741	\$1800	\$1858	\$1933	\$2043	\$2085	\$2181	\$2360	\$2450	\$2617	\$2848	\$3136
		<b>OVERALL DIMENSIONS</b>			<b>SEAT DIMENSIONS</b>			<b>BACK DIMENSIONS</b>					
		W	D	H	W	D	H	W	H				
			25.5	27.5	42.5	22	18	18	21	25			
<p>Active weight 350 lbs.                      Wood armcap option - <b>Add \$165</b></p>													

DESCRIPTION	MODEL#	STANDARD FABRIC GRADES											
		COM	2	3	4	5	6	7	8	9	10	11	12
 <p><b>Bariatric LB Armchair</b> COM Yardage: 2.75 Freight Class: 250 Product Weight (lbs.): 60 Cubic Feet Per Carton: 26.5</p>	GC3711	\$1750	\$1836	\$1909	\$2016	\$2166	\$2222	\$2355	\$2601	\$2726	\$2955	\$3274	\$3667
		OVERALL DIMENSIONS			SEAT DIMENSIONS			BACK DIMENSIONS					
		W	D	H	W	D	H	W	H				
			36	27.5	34.5	32.5	18	18	31	17			

Active weight 750 lbs.  
Wood armcap option - **Add \$165**  
*Armless Bariatric models are not available.*

DESCRIPTION	MODEL#	STANDARD FABRIC GRADES											
		COM	2	3	4	5	6	7	8	9	10	11	12
 <p><b>Bariatric LB Hip Armchair, Post Surgery</b> COM Yardage: 2.75 Freight Class: 250 Product Weight (lbs.): 63 Cubic Feet Per Carton: 30.5</p> <p>Designed to immobilize the pelvis and hip joints after surgery.</p>	GC3711-24	\$2039	\$2125	\$2198	\$2307	\$2453	\$2511	\$2644	\$2890	\$3015	\$3244	\$3565	\$3957
		OVERALL DIMENSIONS			SEAT DIMENSIONS			BACK DIMENSIONS					
		W	D	H	W	D	H	W	H				
			36	27.5	40.5	32.5	18	24	31	17			

Active weight 750 lbs.  
Wood armcap option - **Add \$165**  
*Armless Bariatric models are not available.*

DESCRIPTION	MODEL#	STANDARD FABRIC GRADES											
		COM	2	3	4	5	6	7	8	9	10	11	12
 <p><b>Bariatric HB Armchair</b> COM Yardage: 3.25 Freight Class: 250 Product Weight (lbs.): 66 Cubic Feet Per Carton: 30.5</p>	GC3711HB	\$1939	\$2043	\$2128	\$2252	\$2430	\$2496	\$2654	\$2943	\$3090	\$3363	\$3741	\$4205
		OVERALL DIMENSIONS			SEAT DIMENSIONS			BACK DIMENSIONS					
		W	D	H	W	D	H	W	H				
			36	27.5	42.5	32.5	18	18	31	25			





Active weight 750 lbs.  
Wood armcap option - **Add \$165**  
*Armless Bariatric models are not available.*

DESCRIPTION	MODEL#	STANDARD FABRIC GRADES											
		COM	2	3	4	5	6	7	8	9	10	11	12
 <p><b>Bariatric LB Armchair, Rear Tip &amp; Move Wheels</b> COM Yardage: 2.75 Freight Class: 250 Product Weight (lbs.): 60 Cubic Feet Per Carton: 26.5</p>	GC3712	\$1895	\$1980	\$2054	\$2161	\$2310	\$2367	\$2498	\$2747	\$2870	\$3100	\$3421	\$3812
		OVERALL DIMENSIONS			SEAT DIMENSIONS			BACK DIMENSIONS					
		W	D	H	W	D	H	W	H				
			36	27.5	34.5	32.5	18	18	31	17			

Active weight 750 lbs.  
Wood armcap option - **Add \$165**  
*Armless Bariatric models are not available.*

DESCRIPTION	MODEL#	STANDARD FABRIC GRADES											
		COM	2	3	4	5	6	7	8	9	10	11	12
 <p><b>Bariatric HB Armchair, Rear Tip &amp; Move Wheels</b> COM Yardage: 3.25 Freight Class: 250 Product Weight (lbs.): 66 Cubic Feet Per Carton: 30.5</p>	GC3712HB	\$2081	\$2183	\$2269	\$2394	\$2573	\$2639	\$2795	\$3086	\$3232	\$3504	\$3883	\$4347
		OVERALL DIMENSIONS			SEAT DIMENSIONS			BACK DIMENSIONS					
		W	D	H	W	D	H	W	H				
			36	27.5	42.5	31	18	18	30	25			

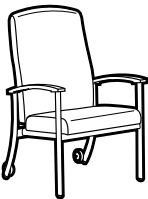
Active weight 750 lbs.  
Wood armcap option - **Add \$165**  
*Armless Bariatric models are not available.*

DESCRIPTION	MODEL#	STANDARD FABRIC GRADES												
		COM	2	3	4	5	6	7	8	9	10	11	12	
 <p><b>LB Armchair, Flex Back</b> COM Yardage: 1.75 Freight Class: 250 Product Weight (lbs.): 49 Cubic Feet Per Carton: 17.5</p>	GC3715	\$1649	\$1702	\$1750	\$1818	\$1913	\$1949	\$2035	\$2192	\$2269	\$2416	\$2618	\$2870	
		OVERALL DIMENSIONS			SEAT DIMENSIONS			BACK DIMENSIONS						
		W	D	H	W	D	H	W	H					
			25.5	27.5	34.5	22	18	18			21	17		
<p>Active weight 350 lbs. Wood armcap option - <b>Add \$165</b></p>														
 <p><b>HB Armchair, Flex Back</b> COM Yardage: 2 Freight Class: 250 Product Weight (lbs.): 50 Cubic Feet Per Carton: 20</p>	GC3715HB	\$1862	\$1922	\$1977	\$2054	\$2161	\$2204	\$2300	\$2480	\$2570	\$2737	\$2969	\$3256	
		OVERALL DIMENSIONS			SEAT DIMENSIONS			BACK DIMENSIONS						
		W	D	H	W	D	H	W	H					
			25.5	27.5	42.5	22	18	18			21	25		
<p>Active weight 350 lbs. Wood armcap option - <b>Add \$165</b></p>														
 <p><b>LB Armchair, Flex Back, Rear Tip &amp; Move Wheels</b> COM Yardage: 1.75 Freight Class: 250 Product Weight (lbs.): 49 Cubic Feet Per Carton: 17.5</p>	GC3716	\$1789	\$1843	\$1889	\$1958	\$2052	\$2089	\$2174	\$2333	\$2408	\$2556	\$2758	\$3009	
		OVERALL DIMENSIONS			SEAT DIMENSIONS			BACK DIMENSIONS						
		W	D	H	W	D	H	W	H					
			25.5	27.5	34.5	22	18	18			21	17		
<p>Active weight 350 lbs. Wood armcap option - <b>Add \$165</b></p>														
 <p><b>HB Armchair, Flex Back, Rear Tip &amp; Move Wheels</b> COM Yardage: 2 Freight Class: 250 Product Weight (lbs.): 50 Cubic Feet Per Carton: 20</p>	GC3716HB	\$2003	\$2062	\$2118	\$2195	\$2305	\$2347	\$2443	\$2622	\$2711	\$2879	\$3110	\$3398	
		OVERALL DIMENSIONS			SEAT DIMENSIONS			BACK DIMENSIONS						
		W	D	H	W	D	H	W	H					
			25.5	27.5	42.5	22	18	18			21	25		
<p>Active weight 350 lbs. Wood armcap option - <b>Add \$165</b></p>														
 <p><b>HB Armchair, Split Back</b> COM Yardage: 2 Freight Class: 250 Product Weight (lbs.): 53 Cubic Feet Per Carton: 20</p>	GC3717HB	\$1873	\$1934	\$1987	\$2066	\$2176	\$2216	\$2310	\$2492	\$2582	\$2750	\$2981	\$3267	
		OVERALL DIMENSIONS			SEAT DIMENSIONS			BACK DIMENSIONS						
		W	D	H	W	D	H	W	H					
			25.5	27.5	42.5	22	18	18			21.5	25		
<p>Fold away headrest. Active weight 350 lbs. Wood armcap option - <b>Add \$165</b></p>														



DESCRIPTION	MODEL#	STANDARD FABRIC GRADES												
		COM	2	3	4	5	6	7	8	9	10	11	12	
 <p><b>HB Armchair, Split Back, Rear Tip &amp; Move Wheels</b> COM Yardage: 2 Freight Class: 250 Product Weight (lbs.): 53 Cubic Feet Per Carton: 20</p>	GC3718HB	\$2015	\$2076	\$2129	\$2208	\$2315	\$2357	\$2452	\$2633	\$2723	\$2890	\$3123	\$3408	
		OVERALL DIMENSIONS			SEAT DIMENSIONS			BACK DIMENSIONS						
		W	D	H	W	D	H	W	H					
		25.5	27.5	42.5				22	18	18	21.5	25		

Fold away headrest.  
Active weight 350 lbs.  
Wood armcap option - Add \$165

DESCRIPTION	MODEL#	STANDARD FABRIC GRADES											
		COM	2	3	4	5	6	7	8	9	10	11	12
 <p><b>Footstool, Angled Top</b> COM Yardage: 1 Freight Class: 150 Product Weight (lbs.): 16 Cubic Feet Per Carton: 3.5</p>	GC3708	\$880	\$910	\$935	\$976	\$1028	\$1051	\$1098	\$1188	\$1233	\$1318	\$1433	\$1576
		OVERALL DIMENSIONS			SEAT DIMENSIONS			BACK DIMENSIONS					
		W	D	H	W	D	H	W	H				
		16.5	18.5	10.5									

Stores beneath any standard seating unit.  
Active weight 350 lbs.

DESCRIPTION	MODEL#	STANDARD FABRIC GRADES											
		COM	2	3	4	5	6	7	8	9	10	11	12
 <p><b>Single Seat Bench</b> COM Yardage: 1.25 Freight Class: 250 Product Weight (lbs.): 25 Cubic Feet Per Carton: 8.5</p>	GC3721	\$981	\$1019	\$1053	\$1100	\$1169	\$1194	\$1255	\$1367	\$1424	\$1529	\$1671	\$1853
		OVERALL DIMENSIONS			SEAT DIMENSIONS			BACK DIMENSIONS					
		W	D	H	W	D	H	W	H				
		24.75	23.5	18									

Active weight 350 lbs.

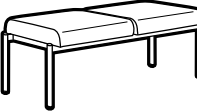
DESCRIPTION	MODEL#	STANDARD FABRIC GRADES											
		COM	2	3	4	5	6	7	8	9	10	11	12
 <p><b>Two Seat Bench</b> COM Yardage: 1.75 Freight Class: 250 Product Weight (lbs.): 48 Cubic Feet Per Carton: 23</p>	GC3722	\$1474	\$1528	\$1576	\$1644	\$1738	\$1775	\$1858	\$2015	\$2095	\$2241	\$2444	\$2696
		OVERALL DIMENSIONS			SEAT DIMENSIONS			BACK DIMENSIONS					
		W	D	H	W	D	H	W	H				
		47.5	23.5	18									

Active weight 350 lbs./seat

DESCRIPTION	MODEL#	STANDARD FABRIC GRADES											
		COM	2	3	4	5	6	7	8	9	10	11	12
 <p><b>Three Seat Bench</b> COM Yardage: 2 Freight Class: 250 Product Weight (lbs.): 68 Cubic Feet Per Carton: 33.25</p>	GC3723	\$1921	\$1982	\$2033	\$2114	\$2221	\$2263	\$2359	\$2539	\$2629	\$2797	\$3028	\$3314
		OVERALL DIMENSIONS			SEAT DIMENSIONS			BACK DIMENSIONS					
		W	D	H	W	D	H	W	H				
		70	23.5	18									

Active weight 350 lbs./seat

DESCRIPTION

MODEL#

STANDARD FABRIC GRADES

WINGBACK



model GC3787C

STANDARD FEATURES

- Traditional styling, easy to exit and features removable and replaceable seats.
- For added comfort, seats are standard with high density foam.
- Standard glide is plastic.
- Wood legs are available in a variety of finishes. Available in Maple wood only species.
- For textile and finish options, visit the website at [globalfurnituregroup.com](http://globalfurnituregroup.com)
- Can be upholstered in standard Global textiles if Healthcare compliance is not required.
- Shipped fully assembled.

OPTIONAL FEATURES

- For non-slip glides specify **(NS)** - Add **\$32**
- For moisture barrier (seat only) - Add **\$178** per seat.

SUGGESTED APPLICATIONS

- Guest seating
- Lobbies
- Lounge/Waiting
- Patient rooms
- Resident rooms

DESCRIPTION

MODEL#

STANDARD TEXTILE GRADES

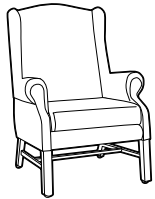

	COM	2	3	4	5	6	7	8	9	10	11	12
<b>GC3787C</b>	<b>\$1709</b>	<b>\$1843</b>	<b>\$2053</b>	<b>\$2233</b>	<b>\$2486</b>	<b>\$2583</b>	<b>\$2805</b>	<b>\$3225</b>	<b>\$3432</b>	<b>\$3818</b>	<b>\$4357</b>	<b>\$5027</b>

OVERALL DIMENSIONS

SEAT DIMENSIONS

BACK DIMENSIONS

W	D	H	W	D	H	W	H
29	30	39	19.5	18	17.5	19.5	22

HB Armchair, Chippendale Legs

COM Yardage: 4.75  
 Freight Class: 250  
 Product Weight (lbs.): 50  
 Cubic Feet Per Carton: 22.25

Active weight 300 lbs.  
 Removable seat cushion.

DESCRIPTION	MODEL#	STANDARD TEXTILE GRADES											
		COM	2	3	4	5	6	7	8	9	10	11	12

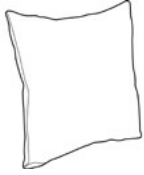

<b>GCTP1515</b>	<b>\$187</b>	<b>\$206</b>	<b>\$237</b>	<b>\$265</b>	<b>\$305</b>	<b>\$321</b>	<b>\$353</b>	<b>\$422</b>	<b>\$455</b>	<b>\$516</b>	<b>\$601</b>	<b>\$706</b>
-----------------	--------------	--------------	--------------	--------------	--------------	--------------	--------------	--------------	--------------	--------------	--------------	--------------

OVERALL DIMENSIONS			SEAT DIMENSIONS			BACK DIMENSIONS	
W	D	H	W	D	H	W	H
15	15	6					

**Pillow** for healthcare seating models  
 COM Yardage: 0.75  
 Freight Class: 70  
 Product Weight (lbs.): 1  
 Cubic Feet Per Carton: 1.3

DESCRIPTION	MODEL#	STANDARD TEXTILE GRADES											
		COM	2	3	4	5	6	7	8	9	10	11	12

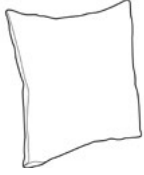

<b>GCTP2020</b>	<b>\$226</b>	<b>\$247</b>	<b>\$268</b>	<b>\$295</b>	<b>\$335</b>	<b>\$355</b>	<b>\$390</b>	<b>\$447</b>	<b>\$491</b>	<b>\$540</b>	<b>\$641</b>	<b>\$748</b>
-----------------	--------------	--------------	--------------	--------------	--------------	--------------	--------------	--------------	--------------	--------------	--------------	--------------

OVERALL DIMENSIONS			SEAT DIMENSIONS			BACK DIMENSIONS	
W	D	H	W	D	H	W	H
20	20	6					

**Pillow** for healthcare seating models  
 COM Yardage: 0.75  
 Freight Class: 70  
 Product Weight (lbs.): 1.5  
 Cubic Feet Per Carton: 1.3

# textiles + finishes

# TEXTILES & FINISHES

## TEXTILES

For a complete listing of healthcare carded textiles, please refer to our website at [www.globalfurnituregroup.com](http://www.globalfurnituregroup.com).

## SEATING FINISHES

### METAL

Black (BLK)	Kalua (KAL)	Latte (LAB)	Mocha (J52)	Shadow (SHW)	Toast (TOA)
Tungsten (TUN)					

### WOOD

Absolute (AAM)	Cherry (ACM)	Charcoal Java (CJM)	Empire Mahogany (EMM)	English Oak (EOM)	Espresso Cafe (ECM)
Fruitwood (TFM)	Gray (HGM)	Harvest Oak (HOM)	Honey (AHM)	Jet Onyx (JOM)	Light Honey (LHM)
Mahogany (TMM)	Maple (AVM)	Medium Walnut (MWM)	Natural Walnut (NLW)	Night (ASM)	Noce Biondo (NBM)
Noce Grigio (NGM)	Noce Leggero (NEM)	Noce Medio (NMM)	Sandy Beach (SBM)	Shaker Cherry (SKM)	Silver Oak (SOM)
Walnut (TWM)	WC Cream (WTM)	White (WHM)	Winter Cherry (WCM)		

Finishes ending with an "M" use Maple wood.

### SELF-SKINNED URETHANE (SSU) ARMCAPS

Black (BLK)	Kalua (KAL)	Latte (LAB)	Mocha (J52)	Shadow (SHW)	Toast (TOA)
-------------	-------------	-------------	-------------	--------------	-------------

### POLYPROPYLENE ARMCAPS

Black (BLK)	Shadow (SW)	Toast (TOA)
-------------	-------------	-------------

## TABLE FINISHES

### THERMALLY FUSED LAMINATES (AUBRA, GC-BELONG, PRIMACARE, TABLET, FLORAL, ENABLE & OCCASIONAL)

Absolute Acajou (ACJ)	Asian Night (ASN)	Avant Cherry (AWC)	Avant Honey (AWH)	Black (BLK)	Brushed Cobalt (BRC)
Clear Maple (CMB)	Dark Espresso (DES)	Designer White (DWT)	Hayden Grey (HGT)	Noce Biondo (NBL)	Noce Grigio (NGL)
Noce Leggero (NEL)	Noce Medio (NML)	Quartered Mahogany (QTM)	Storm Grey (SOG)	Tiger Fruitwood (TFW)	Tiger Walnut (TWL)
Walnut Heights (WHE)	White Chocolate (WHC)	Winter Cherry (WCR)			

### HIGH PRESSURE LAMINATES (AUBRA, GC-BELONG, PRIMACARE, TABLET, FLORAL, ENABLE & OCCASIONAL)

Absolute Acajou (ACJ)	Asian Night (ASN)	Avant Cherry (W357)	Avant Honey (W356)	Black (BLK)	Brushed Cobalt (BRC)
Clear Maple (CMB)	Dark Espresso (W142)	Designer White (DWT)	Hayden Grey (HGT)	Noce Biondo (NBL)	Noce Grigio (NGL)
Noce Leggero (NEL)	Noce Medio (NML)	Quartered Mahogany (QTM)	Storm Grey (SOG)	Tiger Fruitwood (TFW)	Tiger Walnut (W819)
Walnut Heights (WHE)	White Chocolate (WHC)	Winter Cherry (WCR)			

### WOOD OCCASIONAL TABLES

Absolute (AAM)	Charcoal Java (CJM)	Cherry (ACM)	Empire Mahogany (EMM)	English Oak (EOM)	Espresso Cafe (ECM)
Fruitwood (TFM)	Gray (HGM)	Harvest Oak (HOM)	Honey (AHM)	Jet Onyx (JOM)	Light Honey (LHM)
Mahogany (TMM)	Maple (AVM)	Medium Walnut (MWM)	Natural Walnut (NLW)	Night (ASM)	Noce Biondo (NBM)
Noce Grigio (NGM)	Noce Leggero (NEM)	Noce Medio (NMM)	Sandy Beach (SBM)	Shaker Cherry (SKM)	Silver Oak (SOM)
Walnut (TWM)	WC Cream (WTM)	White (WHM)	Winter Cherry (WCM)		

Please refer to the Tables section for availability and coordinating Wood Base & Leg Finishes.

### METAL TABLE LEGS

Please refer to the specific table series for finish listings.

## OVERBED TABLE FINISHES

### THERMOFOIL TOPS

Candlelight (TCL)	Chocolate Pear (TCP)	Medium Cherry (TMC)	Medium Oak (TMO)
-------------------	----------------------	---------------------	------------------

### STEEL BASES

Almond (AL)	Graphite Grey (GG)	Nevada (NV)
-------------	--------------------	-------------

## PERSONAL ROOM FURNITURE FINISHES

### ALDON - LAMINATES

Absolute Acajou (ACJ)	Asian Night (ASN)	Avant Cherry (AWC)	Avant Honey (AWH)	Black (BLK)	Brushed Cobalt (BRC)
Clear Maple (CMB)	Dark Espresso (DES)	Designer White (DWT)	Hayden Grey (HGT)	Noce Biondo (NBL)	Noce Grigio (NGL)
Noce Leggero (NEL)	Noce Medio (NML)	Quartered Mahogany (QTM)	Storm Grey (SOG)	Tiger Fruitwood (FTW)	Tiger Walnut (TWL)
Walnut Heights (WHE)	White Chocolate (WHC)	Winter Cherry (WCR)			

### ALDON - CORIAN TOP (BEDSIDE CABINETS ONLY)

Antarctica (ANT)	Linen (LIN)	Bisque (BIS)	Platinum (PLT)	Bone (BNE)	Savannah (SAV)
Cameo White (CWH)	Silver Grey (SGR)	Glacier White (GWH)			

### SONOMA - LAMINATES

Absolute Acajou (ACJ)	Asian Night (ASN)	Avant Cherry (AWC)	Avant Honey (AWH)	Black (BLK)	Brushed Cobalt (BRC)
Clear Maple (CMB)	Dark Espresso (DES)	Designer White (DWT)	Hayden Grey (HGT)	Noce Biondo (NBL)	Noce Grigio (NGL)
Noce Leggero (NEL)	Noce Medio (NML)	Quartered Mahogany (QTM)	Storm Grey (SOG)	Tiger Fruitwood (FTW)	Tiger Walnut (TWL)
Walnut Heights (WHE)	White Chocolate (WHC)	Winter Cherry (WCR)			

### SONOMA - CORIAN TOP AND FASCIA (BEDSIDE CABINETS ONLY)

Antarctica (ANT)	Bisque (BIS)	Bone (BNE)	Cameo White (CWH)	Glacier White (GWH)	Linen (LIN)
Platinum (PLT)	Savannah (SAV)	Silver Grey (SGR)			

### SONOMA - ALUMINUM EXTRUSIONS

Black (BK)	Charcoal (CG)	Kalua (KL)	Latte (LT)	Mocha (MC)	Nevada (NV)
Sierra (SC)	Silver (SL)	Taupe (TP)	Tungsten (TN)		

For a complete listing of healthcare textiles and finishes, please refer to our website at [www.globalfurnituregroup.com](http://www.globalfurnituregroup.com).

# TEXTILES & FINISHES

## Blended Seating Textiles

The grid below outlines the grade structure for using multiple textiles on select seating series. Blended textiles occur when one textile is chosen for one part of the chair and a different textile is selected for another part of the chair, resulting in a revised blended grade. For opportunities regarding more than two different textiles, please contact Global CustomerCare for approval process and grading.

### FIRST TEXTILE SELECTED

		1	2	3	4	5	6	7	8	9	10	11	12	13	14	15	16	17	18		
SECOND TEXTILE SELECTED	1	1																			
	2	2	2																		
	3	3	3	3																	
	4	3	4	4	4																
	5	4	4	5	5	5															
	6	5	5	5	6	6	6														
	7	5	6	6	6	7	7	7													
	8	6	6	7	7	7	8	8	8												
	9	7	7	7	8	8	8	9	9	9											
	10	8	8	8	8	9	9	9	10	10	10										
	11	9	9	9	9	9	10	10	10	11	11	11									
	12	10	10	10	10	10	10	11	11	11	12	12	12								
	13	11	11	11	11	11	11	12	12	12	12	13	13	13							
	14	11	12	12	12	12	12	12	13	13	13	13	14	14	14						
	15	12	12	13	13	13	13	13	13	14	14	14	14	15	15	15					
	16	13	13	13	14	14	14	14	14	14	15	15	15	15	16	16	16				
	17	14	14	14	14	15	15	15	15	15	15	16	16	16	16	17	17	17			
	18	15	15	15	15	15	16	16	16	16	16	16	17	17	17	17	18	18	18		

## ALTERNATIVE TEXTILE OPTIONS

### GPM - Global Purchased (customer specified) Material

For a greater selection of upholstery options, please visit the following websites. Global will be happy to provide as a G.P.M.

Supplier's Name	Website	Phone number to call for Memo Samples
CF Stinson	<a href="http://www.cfstinson.com">www.cfstinson.com</a>	800.841.6279
Maharam Textiles	<a href="http://www.maharam.com">www.maharam.com</a>	800.645.3943
Mayer Fabrics	<a href="http://www.mayerfabrics.com">www.mayerfabrics.com</a>	800.428.4415
Momentum Textiles	<a href="http://www.themomgroup.com">www.themomgroup.com</a>	800.366.6839
Morbern	<a href="http://www.morbern.com">www.morbern.com</a>	336.883.4332

To access any of the selected suppliers' textiles for use on healthcare products as a G.P.M. (Global Purchases [customer specified] Material), please contact your Global Territory Manager or Global Customer Care Department.

**NOTE: Please contact Global Customer Care for inquiries regarding grading as a G.P.M. on any selected for use from the above mentioned suppliers.**



# GLOBALCARE C.O.M. AUTHORIZATION FORM

## CUSTOMER INFORMATION

To be completed by the dealer/design firm. Use one form per textile. Incomplete information may delay or prevent approval.

A+D/Dealer/Company Name:			Contact:		
Billing Address:			Phone:		
City:	State:	Zip:	Fax:		
End-User/Project Name:			End-User/Project Registered? YES NO If YES, The Global Quote#:		
Local Global Distribution Center:			Date:		

## TEXTILE APPLICATION INFORMATION

SEATING MODEL NUMBER	QUANTITY	SPECIAL INSTRUCTIONS

Textile Name (Series/Style #):

Textile Color Name and Description:

Country of Origin:

Mill or Manufacturer's Name:

Textile Content (% Cotton, % Poly, % Wool, etc.):

Textile Width:

Pattern Repeat:  VERTICAL  HORIZONTAL

Rail Roaded?  YES  NO

### TEXTILE DIRECTION



**STAPLE FABRIC TO THIS FORM IN THE DIRECTION IN WHICH THE FABRIC IS TO BE UPHOLSTERED WITH THE TOP OF THIS PAGE BEING THE SAME AS THE TOP OF THE CHAIR.**

### NEW TEXTILE

Attached textile sample  
(Minimum 5"x 5", Max 12"x 12")  
In correct DIRECTION and SIDE.

### PREVIOUSLY APPROVED TEXTILE

Please e-mail completed form to:  
ComRequest@globalfurnituregroup.com

### MAIL FORM AND TEXTILE SAMPLE ONLY TO:

GLOBAL - COM Department  
17 West Stow Road  
Marlton, NJ 08053 | 856.596.3390

Please contact your local GLOBAL Distribution Center for status of all COM requests. When textile is approved and an authorization number issued, a set of shipping instructions will be faxed or e-mailed to you.

Approved textiles are to be shipped to the address that will be included with instructions. Do not ship textiles to the address on this form. Dealer is responsible for the shipping expenses. Brokerage fees will be paid for by Global. However, duties imposed by North American Governments related to textile materials, content and Country of Origin, additional fees may apply and will be billed separately.

Please Note: C.O.M Textiles may not be shipped without shipping documents. GLOBAL is not responsible for any material shipped without the authorization number.

**Please be advised that Global has phased out the use of textiles that contain certain Phthalates, including but not limited to: DEHP ( di (2-ethylhexyl) phthalate), DBP (di-n-butyl phthalate), BBP (butyl benzyl phthalate) and DINP (di-isononyl phthalate) (collectively the "Listed Chemicals"). The Listed Chemicals are used in certain types of vinyls. Global cannot accept orders for textiles that contain the Listed Chemicals, if such orders are to be shipped to the U.S.A. or are intended for customers in the U.S.A. If you are not sure if the C.O.M you have selected contains the Listed Chemicals, please contact the manufacturer or supplier of the fabric to verify.**

## GLOBAL AUTHORIZATION FORM (TO BE COMPLETED BY GLOBAL)

CAN#:

TEXTILE YARDAGE (REQUIRED FOR THE ORDER):

GU CODE:



**LEVEL CERTIFIED**  
Many products in various categories



**LEED PARTNERSHIP PROGRAM**  
Products can help you earn credits



**GREENGUARD CERTIFIED**  
Children & Schools Certified

**THE ENVIRONMENT** We believe now more than ever, that it is our responsibility to protect the environment and our precious natural resources for future generations. The growing importance of energy and environmental concerns continues to challenge us in this ever changing marketplace.

As an industry leader, Global continues to take proactive steps towards reducing the negative impacts on the environment. We are building "healthier" offices; investing in Research & Development and new technologies; reducing waste and the consumption of energy; and improving the quality of the air we breathe, all which can have a significant impact on our quality of life.



Epoxy Powder coating process is solvent free. No harmful VOC's or lead. No toxins are released into the atmosphere.

Global's recycled fabrics offer affordable, environmentally responsible alternatives to commercial textiles. We recycle 35,000 lbs of fabric offcuts weekly.



Global has the products and resources to help your projects achieve LEED certification.

New technology allows us to reduce glue usage by 50%. In addition, our polyurethane glue reduces emissions and requires less energy to apply.

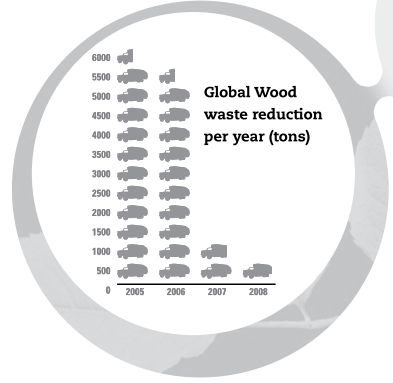

powder paint process:  
**98% paint recovery and reuse**

more recycled fabric  
**less to the landfill**

talk to us about our  
**leed partnership program**

we've diverted  
**90% of our wood waste from landfill in four years**

For further information on Global's environmental initiatives, please visit <http://www.globaltotaloffice.com/enviro/>

Global is focused on providing furniture products for use in healthcare environments. This illustrated price list book has been designed to facilitate fast reference and easy use. Products are categorized into "personal room furniture", "tables" or "seating" and are listed numerically within their categories. The line drawings match actual photographs (where possible) to aid in instant recognition of the total range within a series.

Sales of healthcare products are made only on Global's standard Terms and Conditions of sale which are contained in this price book. The "Purchaser" in these Terms, Conditions and General Information shall refer to dealers and those who originally purchase directly from Global for use or resale. These standard terms and conditions may be modified or supplemented only by a separately written document signed by Global's authorized personnel at its head office in Marlton, NJ. Any term or condition contained in any purchase order or other form used by the Purchaser to order goods (including standard, printed language) which is different from, in addition to, or in any way inconsistent with Global's standard terms and conditions shall be of no force or effect whatsoever.

All illustrations, specifications and prices in this list price book are based on the latest product information available at the time of publication. Global reserves the right to make changes, at any time and without prior notice to prices, colors, materials, specifications and models offered.

## DESCRIPTION

Each product shown or described in this price list is standard healthcare product. Available options are noted at the beginning of each series. Available options may require additional delivery time and cost, and may affect the warranty given. Sizes and weights shown are approximate and are subject to slight changes from time to time.

## PRICES AND PAYMENT

The prices shown in this book, as well as those quoted by Global, are in United States dollars for orders shipped to destinations in the U.S., Mexico and Puerto Rico.

If shipping date requested is more than 90 days from date of order, Global shall reserve the right to use published list prices effective at the time of shipment.

Orders are invoiced at the time of shipment. **Terms of payment are net 30 days from date of invoice (1% 15 days) unless otherwise stated.** The Purchaser agrees that Global shall reserve the right to enforce a charge amounting to 1.5% per month (18% per year) on invoices outstanding more than 30 days.

If the Purchaser's most recent annual net volume is less than \$5,000, payment must be made in advance.

All orders are subject to the Purchaser complying with Global's prevailing credit policy.

Any products sold by Global shall remain the property of Global until fully paid.

Prices are suggested list prices only and are subject to change without notice. Global will, however, attempt to keep the Purchaser up-to-date on all developments including price changes.

## TAXES

All prices shown in this list price book are exclusive of sales, use, excise and other applicable taxes and are the Purchaser's responsibility as per the invoice issued by Global. If the Purchaser claims an exemption from such taxes, it shall be the Purchaser's responsibility to furnish Global with an appropriate exemption certificate at time of order.

## ORDERING INFORMATION

Global requires that all orders be submitted in writing and will be acknowledged on Global's acknowledgment forms governing the transaction.

The details appearing on this acknowledgement will describe the items to be shipped and the approximate shipping date. It is the Purchaser's responsibility to determine that the information in the acknowledgement is correct. In the event of an error, the Purchaser must notify Global immediately by telephone followed by written confirmation. Shipping dates are assigned to orders based on the item having the longest manufacturing lead time (unless instructed to partial ship).

At the time of order, please provide the following information:

1. Account number (if possible)
2. PO number
3. "Bill to" and/or "Ship to" name and address
4. Complete model number and selected options, including textiles/finishes
5. Special instructions and tag information
6. Shipping instructions
7. Special quote (SQ) # or MTM # (if applicable)
8. Customer's Own Material (COM), Global Purchased Material (GPM), Customer's Own Leather (COL), see below.
9. For specials and custom quoted product, please indicate the custom quote # on your PO. If changes are made to the quote, a new quote must be issued prior to submitting the order. It is the Purchaser's responsibility to determine that the information on the quote is correct. Global will not be responsible for wrong product due to errors in the quote.

The above points will be checked by Global for accuracy. Global will process orders using the codes provided by the Purchaser. Price discrepancy is the responsibility of the Purchaser. The Purchaser must notify Global prior to invoicing.

The Purchaser is responsible for providing correct information when placing an order. Orders with incorrect information (finish, etc.) will be scheduled for manufacturing upon receipt of complete information.

To prevent a delay in processing orders, please specify delivery routing.

## CHANGES AND CANCELLATIONS

After the date of Global's acknowledgment of a Purchaser's order, the order may not be changed or canceled by Purchaser without the written consent of Global. Special order items, C.O.M. and fabric-covered items already in production are not subject to change or cancellation under any circumstances. Fabric-covered items are considered to be in production once the fabric is scheduled for cutting.

## ERRORS AND OMISSIONS

All quotations, acknowledgements and invoices are subject to corrections for any errors and omissions.

## FINISHES

### Seating Finishes - Painted

Where painted frames are not a standard color, there is a one time charge of \$613 list price per order for custom wood staining/color matching. Restrictions may apply. The customer must provide a 3" x 3" color chip/sample for review and approval. Non-standard finishes must be approved by Global prior to acceptance of order.

### Seating Finishes - Wood Stained

Because the distinctive characteristics and the nature of wood products cause variations, exact matches are not always possible.

Global coordinates its finishes program between marketing divisions within the Global Group to match products as best as possible when same finishes are specified. However, Global will not be held responsible if the finishes cannot be matched.

## Customers Own Material (COM)

Use of COM must be approved by Global prior to acceptance of order. Please submit the Authorization Request Form.

Photocopy and use this form as often as necessary. The customer must provide a 12" x 12" fabric sample and advise how the fabric is to be applied and quantity of fabric being sent.

**Textile yardage requirement will be advised if factory, and additional yardage may be required if pattern requires matching.** Upon approval from Global, send textile to your Customer Care Representative. If COM is difficult to apply or if product is required to be modified, extra charges will apply. Global reserves the right to cancel an order at any time if COM is inadequate for any reason. COM must be shipped freight and duties paid (if applicable) to our factory. Such shipment must be fully identified with the Purchaser's order number, RGA # provided by Global, and the item for which material is intended. Performance of COM when applied to product is the sole responsibility of the Purchaser. Global's standard product warranty shall not apply to COM. Use of COM will not reduce the published list price.

**C.S.M. (Customer Specified Material)**  
Use of Customer Specified Material must be approved by Global prior to acceptance of order. If C.S.M. is difficult to apply or if product is required to be modified, extra charges shall apply. Global reserves the right to cancel an order at any time if C.S.M. is inadequate for any reason. Performance of C.S.M. when applied to product is the sole responsibility of the Purchaser. Global's standard product warranty shall not apply to C.S.M.

## VINYL AND FABRIC GRADING

All products are priced according to their standard vinyl and fabric grade. Lower grade vinyls and fabrics are available (unless otherwise specified) at same price as standard. The listing of prices for each model indicates a price for each of the upholstery grades. Prices are based on yardage in imperial measurements. Please refer to the Textiles & Finishes section of the Global website for the most up to date listing.

## UPHOLSTERY COVERINGS

Slight variations in color may occur between dye lots. Although Global attempts to minimize these variances, they do occur and must be accepted as normal and will not be considered defects.

## YARDAGE

Required yardage (ydg) is based on unmatched materials with widths of 54" for seating. Yardage calculations are based on imperial measurements.

## WEIGHT

This figure indicates the weight of one part and its packaging, regardless of the number of parts shipped in a single carton. In order to estimate the approximate shipping weight for an order, you have to multiply the indicated weight by the number of parts per carton. (e.g. if a part weight is 10 lbs. and is shipped 4 per carton, shipment weight should be calculated as: 4 x 10 = 40 lbs.)

## CUBIC MEASURE

The stated cubage is an approximate cubic foot measure to calculate freight costs. The figure shown is the volume for the total shipment of a part (e.g. if a part is sent in 2 cartons the volume indicated reflects the cubage of both cartons together) and is subject to change without notice. It is most economical to purchase the specified number per carton.

**DELAYS**

Global's shipping confirmation will state a shipping date which is Global's best estimate at the time the order is acknowledged. However, Global shall not incur any obligation or liability to Purchaser for failure to ship by specified date unless Global has agreed to an unequivocal shipping date in a separately signed written document executed by its authorized personnel at its head office. In addition, Global shall not be liable for any loss or damage resulting from any delay or failure in shipment or other failure to perform all or any part of the agreement between the parties with respect to the goods shown on the face of the order acknowledgement where such delay, failure, loss or damage is the proximate result of any act of any governmental authority or political subdivision thereof, revolution, riot, civil disorder or disturbance, delay or default in transportation, electrical power failure, strike disputes among or between labor unions or other labor disputes, delay or inability in obtaining materials and facilities, fire, flood, act of God or any cause not within the reasonable control of Global, whether of the class of causes enumerated or otherwise.

**SUSPENSION**

In the event that the Purchaser defaults in the payment of any sum due to Global, or in the event the Purchaser's financial condition becomes unsatisfactory to Global, Global shall have the right to defer or discontinue shipment of any goods until such time as the default is cured or the Purchaser provides assurance of payment to Global.

**F.O.B.**

F.O.B. point is Global's Factory, Downsview, Ontario, Canada, or any Global Regional Distribution Center.

**SERVICE**

Service requests are normally the responsibility of Global's authorized dealers. Where this cannot be accomplished on a local level, service problems should be referred to Global's Customer Service Department at the nearest distribution center.

**RETURNS**

No returns of goods will be accepted without written consent and shipping instruction of Global. A minimum re-stocking charge of 35% is made on all authorized returns for credit or refund, provided goods are received by Global in the condition in which they left the factory. This may increase depending on the type of product. Global's Return Goods Authorization (R.G.A.) numbers must appear prominently on all authorized returns. Global will not be responsible for freight costs. No credit will be given if goods cannot be reused as new. Special order items and C.O.M. products are in no event subject to return. All returns must be approved and authorized in writing by Global Customer Care. Global reserves the right to refuse delivery of any unauthorized returns.

**STORAGE CHARGE**

Global reserves the right to assess storage charges if a customer does not accept shipment of an order within a week of shipment or requested ship date.

**CLAIMS**

All goods are sold F.O.B. plant or Global Distribution Center. Global is not responsible for damage which occurs in transit (or in storage). The carrier signs for all goods received in apparently good order. It is the Purchaser's responsibility to examine goods upon receipt and to file any claims with the carrier for losses or damage to the product occurring during transit, including concealed damage.

Any claims made against Global for apparent defects, errors or shortages must be made by the Purchaser, in writing, within 15 working days after any delivery. Failure by the Purchaser to make any claim against Global within 15 days shall constitute acceptance of the goods and a waiver of any apparent defects, errors or shortages.

**COMBINED SHIPMENTS**

Global will make every effort to combine shipments and orders on written request. However, Global cannot be held responsible where such request is not complied with.

**UPS SHIPMENTS**

Seating products marked with a UPS symbol next to the CARTON COUNT are packaged for UPS-able shipments.

**OFFER OF SALE**

Possession of this price list or any other literature shall not imply Global's willingness to sell to the holder and shall not be construed as a direct offer of sale.

*If a conflict arises between: (i) prices found in software support packages furnished to the customer by Global or by any other source on behalf of Global; and (ii) Global's current printed price lists, then the printed price list shall prevail.*

**TESTING QUALIFICATIONS**

Many Global products pass or exceed the most stringent testing procedures. Where tests are significant, they are marked as C.G.S.B. (Canadian General Standards Board) qualified and as passing ANSI/BIFMA (American National Standards Institute/Business Institutional Furniture Manufacturer's Association).

**DISCLAIMER**

All dimensions are in inches. Prices shown are current manufacturer's suggested list prices at the time of printing. All applicable taxes are extra. Descriptions, specifications and prices are subject to change without notice. Errors and omissions are subject to correction.

**COPYRIGHT**

All catalogs, photographs, drawings, price lists and other printed material are protected by copyright. All rights reserved.

**TRADEMARKS**

All trademarks are owned by Global other than OBUSFORME™ which is owned by OBUSFORME LTD. and are used under license and MOR-CARE™ which is owned by MORBERN INC. OBUSFORME® and the distinctive backrest design are registered trademarks of OBUSFORME LTD.

**DESIGNS**

Many of the products produced by Global are protected by Industrial Design Registrations, Design Patents and/or Patents. Designs and specifications are subject to change, discontinuance or additions without notice.

**FLAMMABILITY**

The foam used in Global chairs meets the requirements of California TB117:2013. In addition to the foam, upholstery materials must also meet the California TB117 smolder resistant requirements. Please contact Customer Care to determine if a selected textile meets the California TB117 requirement.

**This list price book is effective as of July 5, 2022.**

*For periodic updates, please check the PDF at [www.globalfurnituregroup.com](http://www.globalfurnituregroup.com). Global warrants that all commercial products are free from defects in material and workmanship, for the life of the product, to the original purchaser.*

Global warrants that all commercial products are free from defects in material and workmanship, for the life of the product, to the original purchaser.

Global will repair or replace, at Global's option, as the sole remedy for any defect covered by the warranty. The warranty applies to products manufactured after March 22, 2016.

Global makes no warranty that any of its products are suitable for any particular purpose and makes no other warranties, express or implied, other than those set out here. As codes and standards vary from one jurisdiction to another, references to compliance are solely for convenience and without any representation as to accuracy or suitability. Users must verify the suitability of such information or product for their specific application. In no event shall Global be liable in either tort or contract for any loss or direct, special, incidental, consequential, or exemplary damages.

### General Healthcare Seating

Global's healthcare warranty for general seating covers all chair components including pneumatic cylinders, bases, casters, glides, frames, arms, plastic seats, backs and other structural components.

The warranty applies to single shift, standard usage, defined as a standard eight (8) hour day, forty (40) hour week as noted with each model number.

Exceptions to the warranty for general seating are as follows:

- Foam, upholstery, textiles (as sampled on Global branded and textile program cards), mesh material and electrical devices are warranted for five (5) years
- Control mechanisms are warranted for twelve (12) years
- Heavy Duty Seating is not defined as General Healthcare Seating (see below for warranty exceptions)

### Heavy Duty / Bariatric Seating

Global offers products designed for multiple shift applications (24 hours a day / 7 days a week) and larger individuals weighing up to 350 and/or 500 lbs or 750 lbs (depending on series and/or model). Global warrants these products for twelve (12) years to the original Purchaser. All components (including control mechanisms, pneumatic cylinders, bases, casters, glides, frames, arms, plastic seats/backs, etc.) are covered for 24/7 applications under the warranty. The exceptions are foam and textiles, which are covered for five (5) years. Fabric or upholstery material on these products must exceed 100,000 double rubs for the textile portion of the warranty to apply. Please refer to [www.globalfurnituregroup.com](http://www.globalfurnituregroup.com) for an up to date list of series and/or applicable models.

### Files, Desks, Modular Furniture, Tables, Panels & Accessories

Global warrants all components of metal storage and filing, laminate and wood veneer desks, laminate and wood veneer tables, metal leg components and panels for the lifetime of the product to the original Purchaser.

### Seating Warranty Summary

Seating Type	Components Warranty For Original Purchaser	Use Time For Warranty Coverage	Exceptions
General healthcare seating	lifetime	8 hours/5 days per week	foam/upholstery/textiles/mesh/electrical devices - 5 Years control mechanisms - 12 years
Heavy duty / bariatric seating	12 years	24 hours/7 days per week	foam/upholstery/textiles - 5 years

### Files, Desks, Modular Furniture, Tables & Accessories Warranty Summary

Product Type	Components Warranty For Original Purchaser	Exceptions
Metal storage and filing	lifetime	none
Laminate/wood veneer desks and modular furniture	lifetime	tackboard textiles, electrical devices, task lights - 5 years
Boardroom, conference and training tables	lifetime	electrical devices - 5 years moving parts - 5 years

### Global's healthcare warranty does not apply (for any product category) to the following:

- Nominal or normal amount of wear and tear that can occur over time
- Failures which result from negligence, abuse, accident or misuse
- Failure to apply, install or maintain products according to Global's written instructions and warnings
- Modifications, attachments or repair methods not approved by Global
- Damage caused by a carrier in transit, or delivery/installation contractors
- The matching of colors, grains or textures (wood, leather, etc.) of natural materials
- Products exposed to extreme hot or cold temperatures or excessively dry or humid environments
- Colorfastness or the matching of color of textiles; dye lots of textile can vary
- Damage by markings or staining; damage by sharp objects or imprinting from instruments
- Damage to textiles or laminate and wood surfaces/edges from exposure to sunlight (including UV rays)
- Products used for rental purposes
- Purchased parts are warranted for one (1) year
- Failure to follow specific cleaning and disinfecting instructions by the textile supplier

Warranty does not cover the costs of transportation or labor. Repair or replacement will be at Global's discretion.

### Textiles and Finishes

Global warrants Global branded textiles and Global carded textile programs inclusive of fabrics, vinyls and leather products for five (5) years. Global does not warrant COM (Customer's Own Material) or GPM (Global Purchased Materials) that are customer specified materials, or graded-in and purchased by Global for a customer. For GPM or COM products, please contact the textile supplier for performance information and warranty details. Please refer to our website at [www.globalfurnituregroup.com](http://www.globalfurnituregroup.com) for a link to the supplier's recommendation for cleaning and disinfecting procedures. Improper usage of disinfecting/cleaning products may void the warranty.

Global textiles and finishes are updated periodically to meet the demand and trends of the market. As a result, some textiles and finishes may be discontinued by Global or the manufacturer. In the event that a textile or finish is discontinued, Global will make every reasonable effort to provide an alternative product(s) of comparable function.

**Global US Headquarters/Distribution Center**

17 West Stow Road, P.O. Box 562  
 Marlton, New Jersey U.S.A. 08053  
 T (856) 596-3390  
 T (800) 220-1900

A \$25 net handling charge per shipment  
 will be applied for non-UPSable orders of  
 less than \$2,000 list.

**Showrooms**

**Atlanta**  
 10 10th Street  
 Suite 150  
 Atlanta, GA 30309  
 T (404) 879-0998

**Boston**  
 One Harbor Street  
 Suite 104  
 Boston, MA 02210  
 T (617) 406-5435

**Chicago**  
 222 Merchandise  
 Mart Plaza  
 10th Floor, Suite 1035  
 Chicago, IL 60654  
 T (312) 755-0843

**Miami**  
 112 NE 41st Street  
 6th floor  
 Miami, FL 33137

**New York City**  
 386 Park Avenue South  
 7th floor  
 New York, NY 10016  
 T (212) 545-9900

**Philadelphia**  
 1735 Market Street  
 38th Floor  
 Philadelphia PA, 19103  
 T (215) 861-0963

**New Jersey (Southern)**  
 119 West Greentree Road  
 Marlton, NJ 08053  
 T (856) 596-3390

**Phoenix**  
 4675 E Cotton Center Blvd.  
 Suite 165  
 Phoenix, AZ 85040  
 T (602) 426-0666  
 T (602) 426-0777

**Washington, DC**  
 1130 Connecticut Avenue  
 10th Floor, Suite 1000  
 Washington, DC 20036  
 T (202) 659-0230  
 T (202) 659-0236

**Distribution Centers**

**Atlanta Area**  
 6715 Maple Ave.  
 Suite 100  
 Buford, GA 30518  
 T (678) 602-4130

**Baltimore Area**  
 Troy Hill  
 Corporate Center  
 7030 Troy Hill Drive  
 Elkridge, MD 21075  
 T (410) 379-8021

**Boston Area**  
 19 Connector Road  
 Unit 1  
 Andover, MA 01810  
 T (978) 470-8463

**Chicago Area**  
 27W501 North Ave.  
 Suite 300  
 West Chicago, IL 60185  
 T (630) 681-2818

**Cincinnati Area**  
 8712 LeSaint Drive  
 Fairfield, OH 45014  
 T (513) 777-0009

**Dallas Area**  
 2025 West Beltline Road  
 #100  
 Carrollton, TX 75006  
 T (972) 236-1366

**Denver Area**  
 16401 East 33rd Drive  
 Suite 50  
 Aurora, CO 80011  
 T (303) 340-1617

**Ft. Lauderdale Area**  
 560 Sawgrass  
 Corporate Pkwy  
 Sunrise, FL 33325  
 T (954) 846-8888

**Houston Area**  
 7865 Northcourt Road  
 Suite 200  
 Houston, TX 77040  
 T (713) 695-5777

**Los Angeles Area**  
 3629 Workman Mill Road  
 Whittier, CA 90670  
 T (562) 484-9686

**Seattle Area**  
 Oakesdale Commerce Ctr.  
 820 Southwest 34th Street  
 Building W7, Suite A  
 Renton, WA 98057  
 T (425) 291-9282

**Kansas City Area**  
 11617 West 81st Street  
 Lenexa, KS 66214  
 T (913) 310-9963

**Tampa Area**  
 10351 Windhorst Road  
 Tampa, FL 33619  
 T (813) 621-6272

